

DENTAL
INSTRUMENTS
CATALOGUE

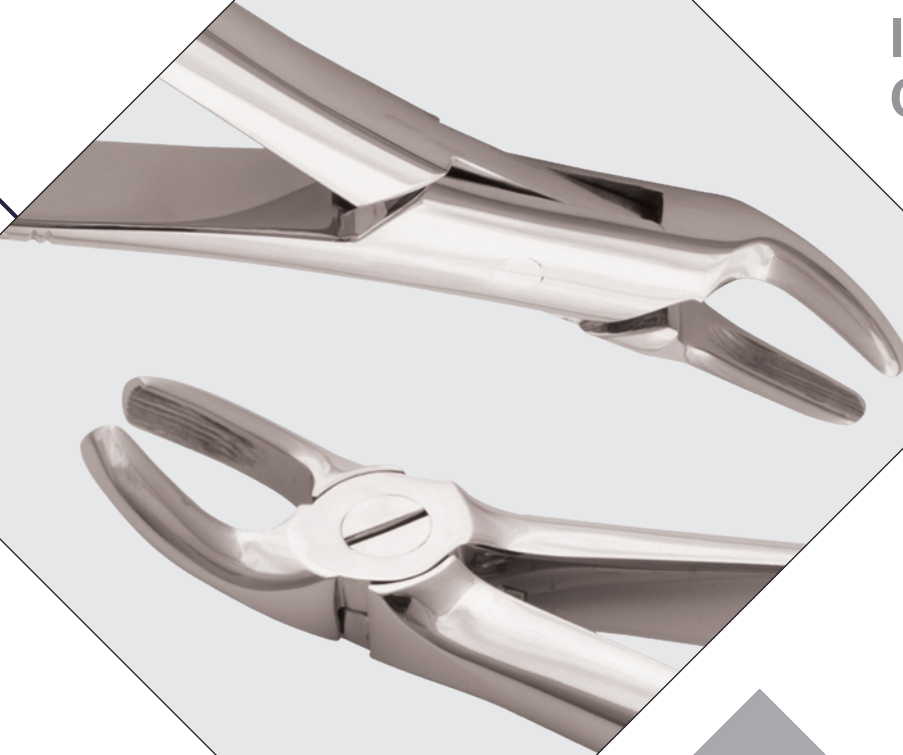

CEO MESSAGE

At Zona Industries, our mission is to deliver precision-engineered surgical, dental, and beauty instruments that healthcare professionals can rely on with confidence.

Our foundation is built on quality craftsmanship, consistent performance, and a forward-thinking approach to manufacturing. With years of industry experience, we have cultivated strong capabilities in product development, manufacturing excellence, and international supply.

By integrating modern technology with the expertise of our skilled workforce, we continuously enhance our products to meet the dynamic requirements of the global medical sector. We believe that true success comes from teamwork and synergy.

Our research & development, production, quality assurance, and marketing departments work in close alignment to ensure innovation, efficiency, and consistency at every stage. This unified approach enables us to deliver solutions that add real value to our customers' practices.

Our operations strictly adhere to international standards and regulatory requirements, including CE compliance, ISO 9001, and ISO 13485 certifications. Rigorous quality control systems and detailed inspection procedures are embedded in our processes to ensure each product meets the highest standards of safety and reliability.

We are committed to building long-term partnerships by providing dependable products, timely deliveries, and responsive customer service. At Zona, we don't just manufacture instruments — we contribute to better healthcare outcomes worldwide.

Zona Industries
Chief Executive Officer



COMPANY PROFILE

At Zona Industries, we take pride in being a trusted manufacturer and exporter of premium-quality surgical and dental instruments, designed to meet professional standards across global markets.

With a strong presence in international trade, we supply our instruments to customers worldwide, delivering consistent quality and reliability in every shipment. Our steady growth reflects our commitment to excellence, innovation, and customer satisfaction. In a relatively short span, we have expanded our product portfolio to include a wide range of instruments, while continuously upgrading our manufacturing processes and quality systems.

Our certifications and compliance with international standards demonstrate our dedication to delivering products that meet the expectations of modern healthcare professionals. We believe that quality is not just a promise — it is the foundation of everything we do.

PRODUCT LINE

We operate as original equipment manufacturers (OEM) specializing in surgical and dental instruments, offering a comprehensive and diverse product range to meet global market demands.

Our portfolio includes thousands of instrument variations, covering everything from commonly used clinical tools to advanced instruments required for specialized surgical procedures. With a strong manufacturing base and skilled workforce, we ensure precision, durability, and consistency across all product categories.

In addition to our standard range, our capabilities extend beyond the products featured in our catalogs. We welcome customized manufacturing requests and are fully equipped to develop instruments based on customer-provided samples, technical drawings, images, or references from internationally recognized brands.



KEY STRENGTH

Zona is committed to manufacturing and delivering high quality surgical and dental instruments to customers worldwide. Over the years, we have achieved consistent growth by focusing on reliability, precision, and customer satisfaction, supported by our core strengths outlined below.



HIGH QUALITY PRODUCTS

Precision-driven manufacturing is the foundation of our operations, supported by a strong commitment to delivering instruments that meet the highest standards of accuracy and reliability. Every product undergoes strict quality control to ensure it is free from defects and ready for professional use.

We understand the importance of timely deliveries in maintaining smooth business operations. With an efficient production system and a well-organized supply chain, we ensure that all orders are processed and dispatched within the committed timelines

ON TIME DELIVERIES

EFFECTIVE CUSTOMER SERVICE

We believe that effective customer service is essential to building long-term relationships. Our team is dedicated to providing prompt responses, clear communication, and reliable support at every stage of the process. From initial inquiries to after-sales assistance, we ensure that our customers receive the attention and service they deserve.



50



Extracting Forceps, American Pattern
Zahnzangen, Amerikanische Form
Daviers, forme américaine
Forceps de extracción, forma americana
Pinze per estrozione, forma americana

Page 01 to 15

51



Extracting forceps, English pattern
Zahnzangen, Englische Form
Daviers, forme anglaise
Fórceps dentales, forma inglesa
Pinze per estrazione, forma inglese

Page 16 - 38

52



Root Elevators
Wurzelheber
Elévateurs á racines
Botadores para raíces
Leve per radici

Page 40 to 54

53



Bone Files
Bone-Dateien
Archivos de huesos
Fichiers d'os
Bone Files

Page 55 to 56

54



Dental Probes
Zahnsonden
Sondas dentales
Sondes dentaires
Sonde dentali

Page 57 to 58

55



Enamel Instruments
Emaille-Instrumente
Instrumentos de esmalte
Instrument d'émail
Strumenti per smalto







Page 59 to 62

56

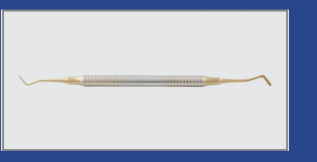

Dental Scalers
Zahnsteinentferner
Escaladores dentales
Scalers dentaires
Scaler dentali

Page 63 to 78

57		Bone Curettes Knochenküretten Curetas de hueso Curettes osseuses Curette d'ossa	Page 79 to 84
58		Excavators Bagger Excavadoras Pelles escavatori	Page 85 to 89
59		Wax Proclein Wachs-Porzellan cera Porcelana Cire Porcelaine Cera porcellana	Page 90 to 94
60		Filling Instruments Füllungsinstrumente Actos de llenado Instruments de remplissage Strumenti di riempimento	Page 95 to 105
61		Gingivectomy Knives Gingivektomie Messer Cuchillos de gingivectomía Couteaux de gingivectomie Coltelli per gengivectomia	Page 106 to 107
62		Cement Spatulas Zementspatel Espátulas de cemento Spatules de ciment Spatole di cemento	Page 108 to 112
63		Mouth Mirrors Mundspiegel Espejos bucales Bouche Miroirs Bocca specchi	Page 113 to 115

64

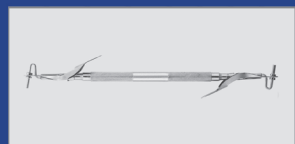

Amalgam Instruments
Amalgam Instrumente
Instrumentos de amalgama
Instruments Amalgam
Strumenti amalgama **Page 116 to 117**

65



Matrix Retainers
Matrix-Halterungen
Retenedores de matrices
Retenue de matrice
Matrix Retainers **Page 118 to 125**

66



Hemostatic Forceps
Arterienklemmen
Pinces hemostaticas
Pinzashemostaticas
Pinze emostatiche **Page 126 to 132**

67



Towel Clamps
Handtuchklammern
Abrazaderas de toalla
Pinces à serviettes
Morsetti per asciugamano **Page 133 to 134**

68



Needle Holders
Nadelhalter
Porte-aiguilles
Porta-agujcs
Port' aghi **Page 135 to 143**

69



Retractors
Wundhaken
Ecarteurs
Separadores
Divaricatori **Page 144 to 148**

70



Mouth and Tongue
Mund und Zunge
Boca y la lengua
Bouche et langue
Bocca e la lingua **Page 149 to 152**

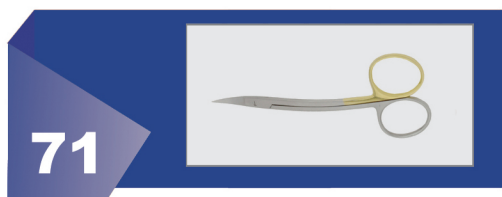

71

**Scissors
Schere
Tijeras
Les ciseaux
Forbici**

Page 153 to 171

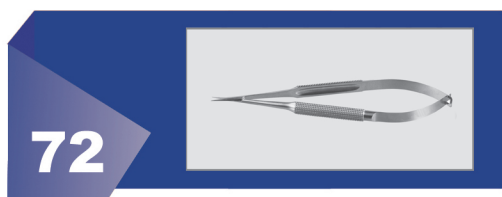

72

**Micro Scissors
Mikroschere
Micro tijeras
Micro-ciseaux
Micro forbici**

Page 172 to 173

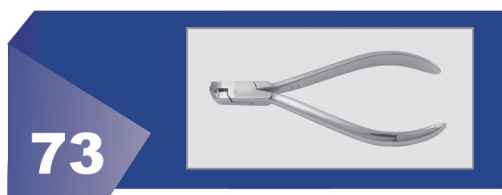

73

**Orthodontics
Kieferorthopädie
Ortodoncia
Orthodontie
Ortodonzia**

Page 174 to 190



74

**Bone Rongeurs
Knochen Rongeur
Rongeurs de hueso
Os Rongeurs
Bone Rongeurs**

Page 191 to 193

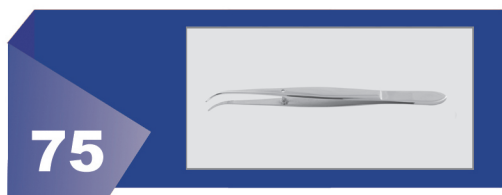

75

**Forceps
Zange
Fórceps
Forceps
forcipe**

Page 194 to 201

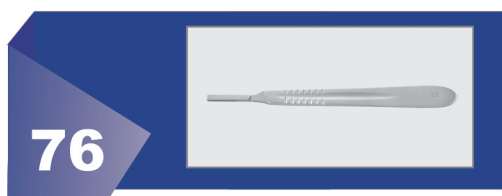

76

**Scalpel Handles
Skalpelli
Manches de bistouris
Mangos de Bisturías
Manici per bisturi**

Page 202 to 203

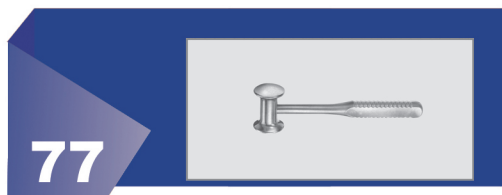

77

**Mallets
Schlägel
Mazos
Maillets
Mallets**

Page 204 to 206

78



Cassettes
Kassetten
Cassettes
Cassettes
cassette

Page 207 to 210

79

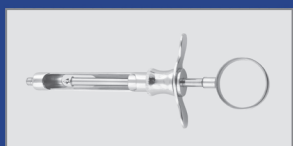

Cylinder cartidge syringe
Zylinder-Ampullenspritze
Seringue á ampoule cylindrique
Jeringo para cartucho ampollas
Siringe ampollare a cilindro

Page 211 to 216

80



Impression Trays
Abdrucklöffel
Porte empreintes
Cubetas para impresiones
Portaimpronte

Page 217 to 228

81



Articulators
Artikulatoren
Articuladores
Articulateurs
articolatori

Page 229 to 230

82



Holloware
Holloware
holloware
Platerie
Holloware

Page 231 to 236

50

- EN** Extracting Forceps, American Pattern
- DE** Zahnzangen, Amerikanische Form
- ES** Daviers, forme américaine

Page 01 to 15

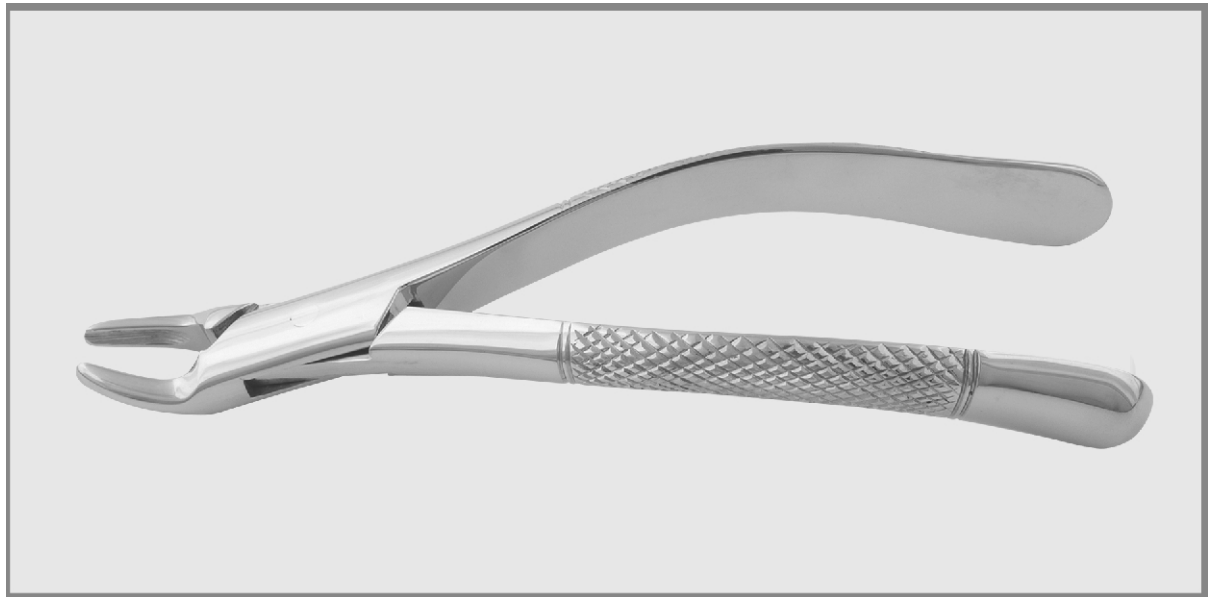
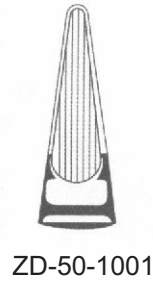
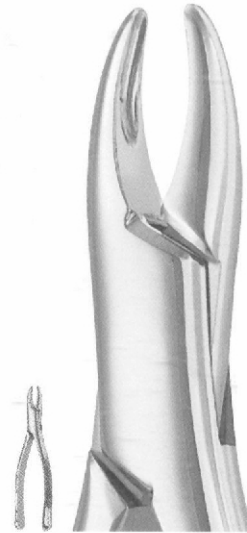



Fig. 1



ZD-50-1001



HENAHAN
Fig. 1 A

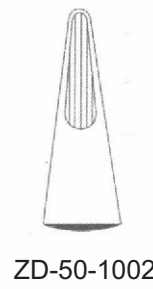

ZD-50-1002



Fig. 1 B

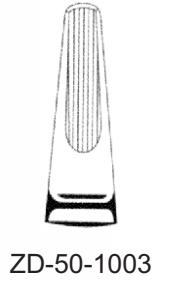

ZD-50-1003



MILWAUKEE
Fig. 3



ZD-50-1004

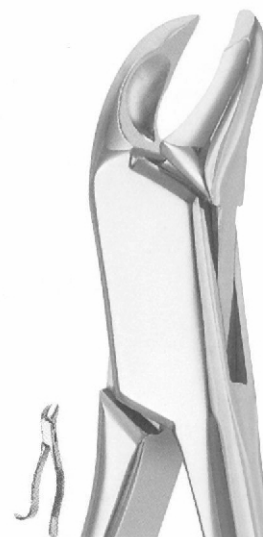

WOOD-WARD
Fig. 3 FH



ZD-50-1005

EXTRACTION

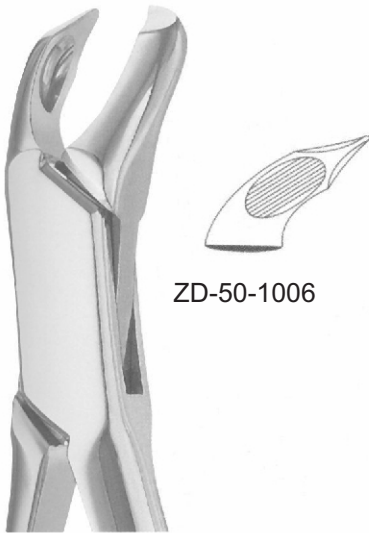

ZD-50-1006

WOOD-WARD
 Fig. 3 FS



ZD-50-1007

PHYSICK
 Fig. 5

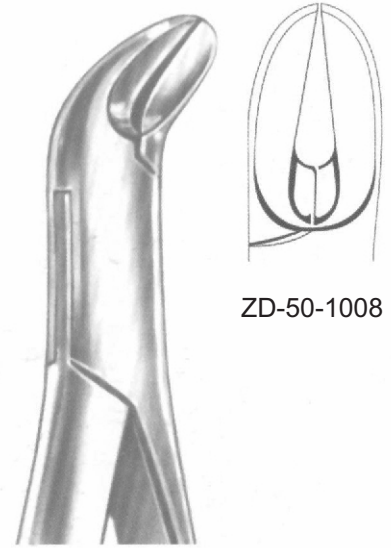

ZD-50-1008

Fig. 6

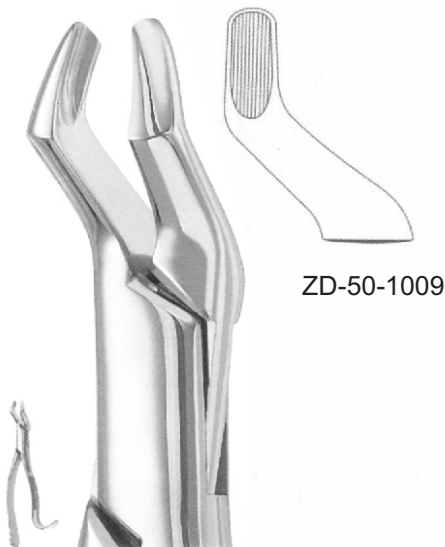

ZD-50-1009

Fig . 10 H

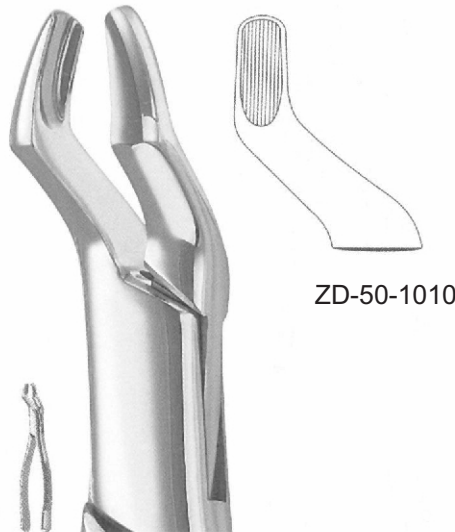

ZD-50-1010

Fig . 10 S

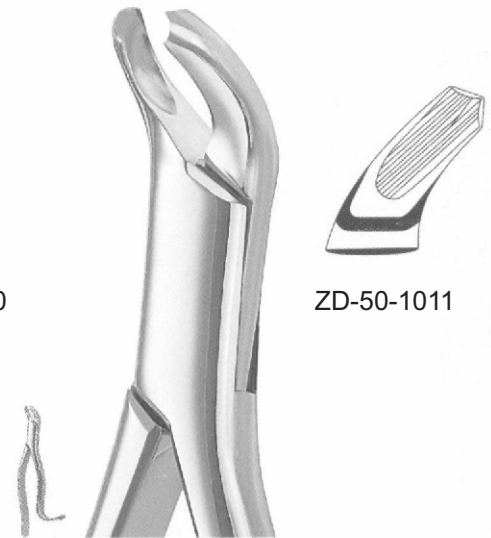

ZD-50-1011

HARRIS
 Fig . 15

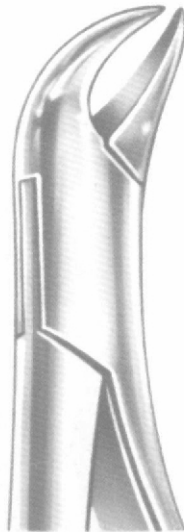

ZD-50-1012



HARRIS
Fig. 16



ZD-50-1013

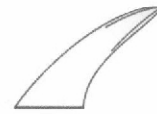

Fig. 16 S



ZD-50-1014



Fig. 17



ZD-50-1015

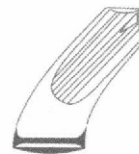

HARRIS
Fig. 18 L



ZD-50-1016



HARRIS
Fig. 18 R

EXTRACTION

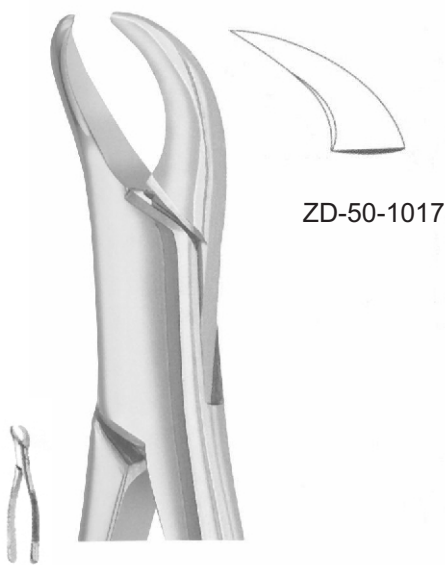

Fig. 23

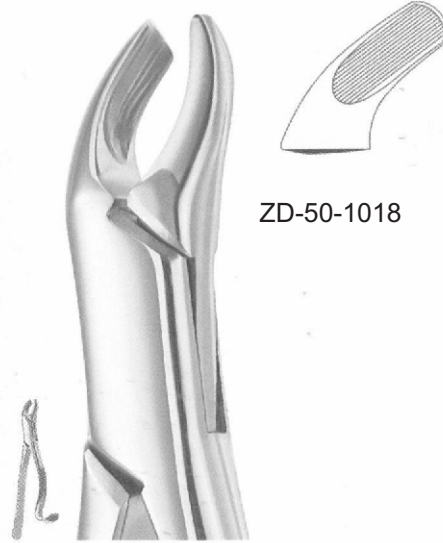

Fig. 24

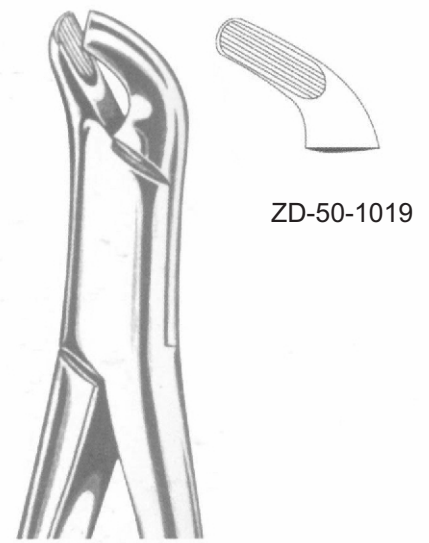
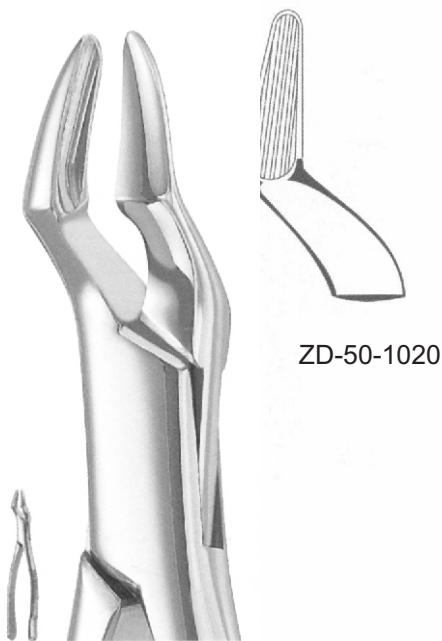
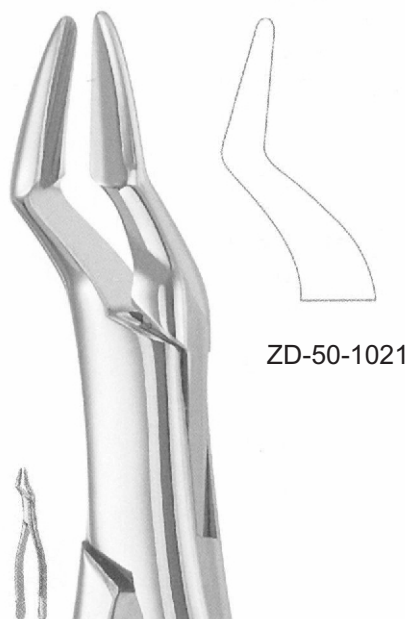

Fig. 27



PARMLY
Fig. 32



PARMLY
Fig. 32 A

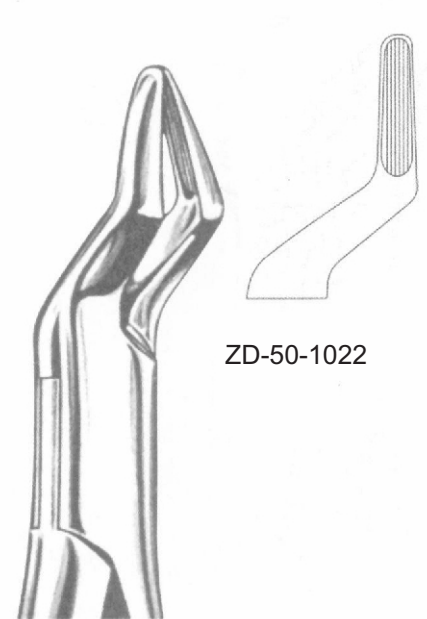

Fig. 35



ZD-50-1023

Fig. 53 L



ZD-50-1024

Fig. 53 R

EXTRACTION



Fig. 62



ZD-50-1025



Fig. 65

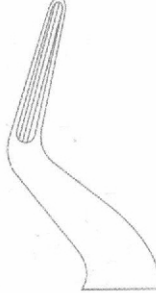

ZD-50-1026



TOMES
Fig. 69



ZD-50-1027



THOMAS
Fig. 85

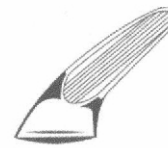

ZD-50-1028



THOMAS
Fig. 85 A



ZD-50-1029



NEVIUS
Fig. 88 L

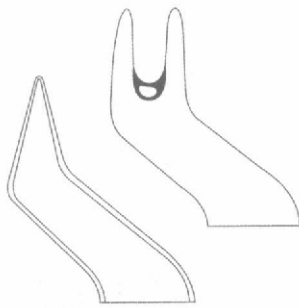

ZD-50-1030



NEVIUS
Fig. 88 R

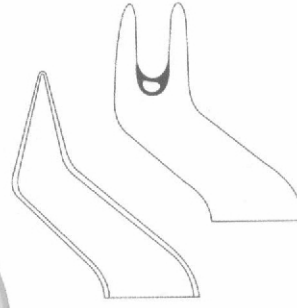

ZD-50-1031



KELLS
Fig. 99 A

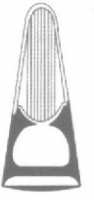

ZD-50-1032



KELLS
Fig. 99 C



ZD-50-1033



HULL
Fig. 101



ZD-50-1034

EXTRACTION

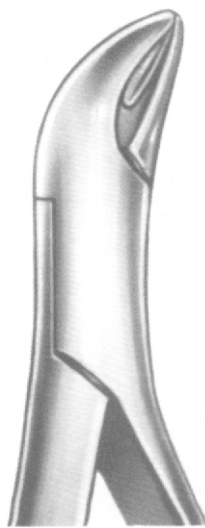
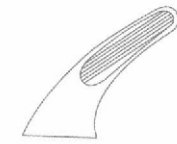

Fig. 103



ZD-50-1035



Fig. 10 H



ZD-50-1036



Fig. 10 S

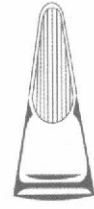

ZD-50-1037



CRYER
Fig. 150



ZD-50-1038



CRYER
Fig. 150 A



ZD-50-1039



Fig. 150 X

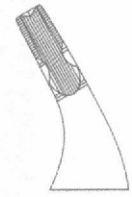

ZD-50-1040



ZD-50-1041



ZD-50-1042



ZD-50-1043

Fig. 150 AB

Fig. 150 AS

CRYER
Fig. 150 S

EXTRACTION

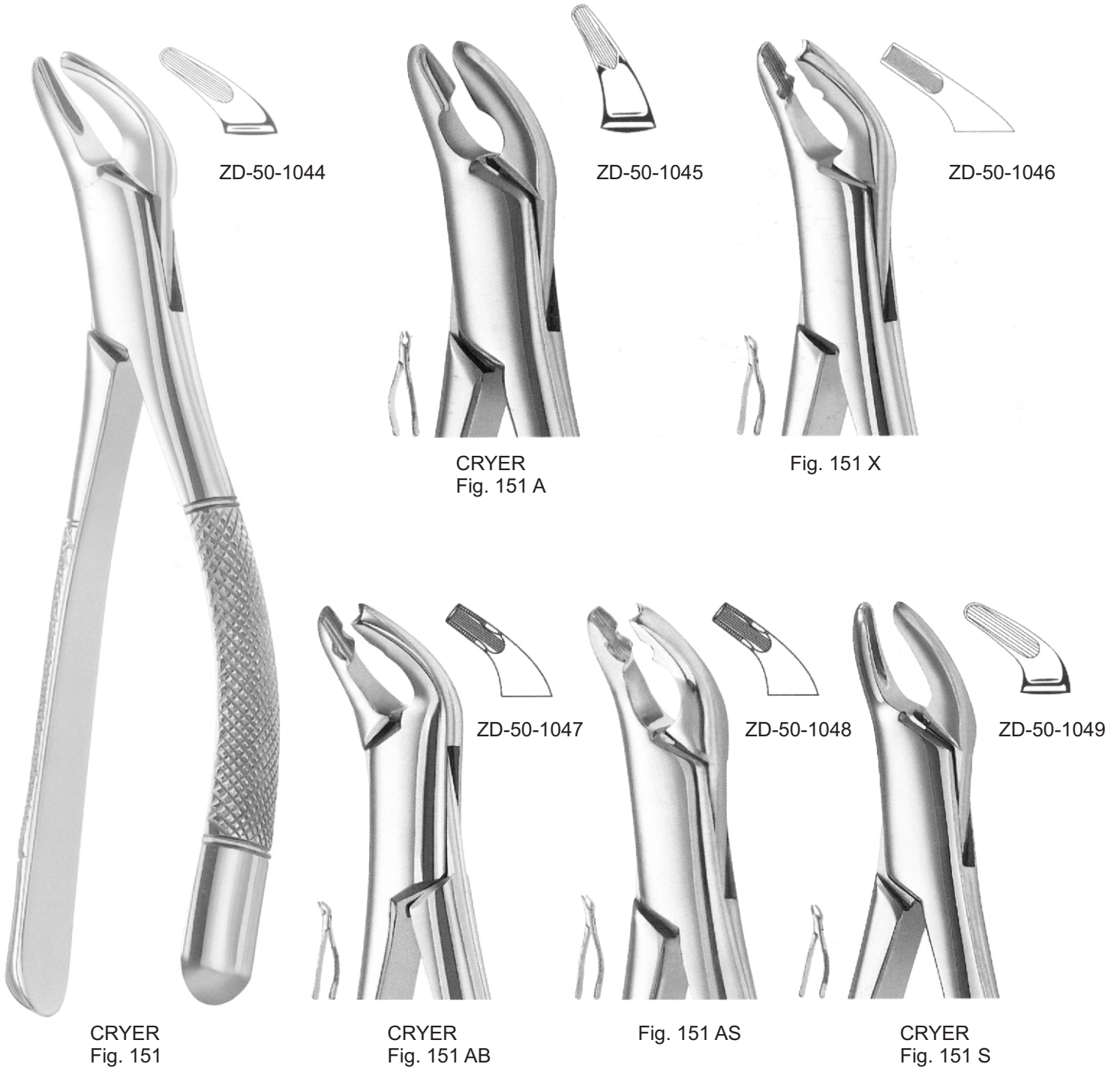



Fig.201

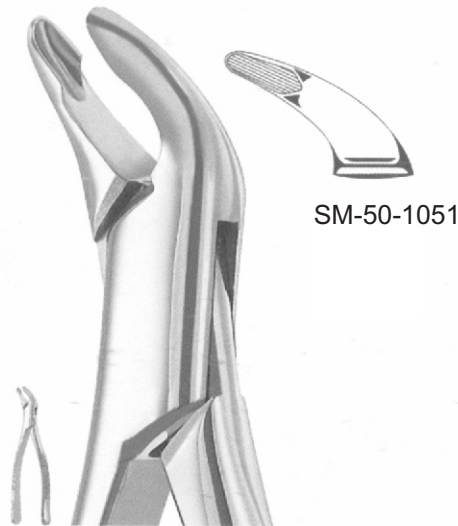
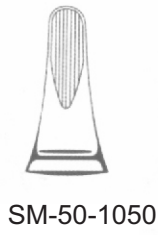

Fig.203

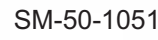

Fig.217

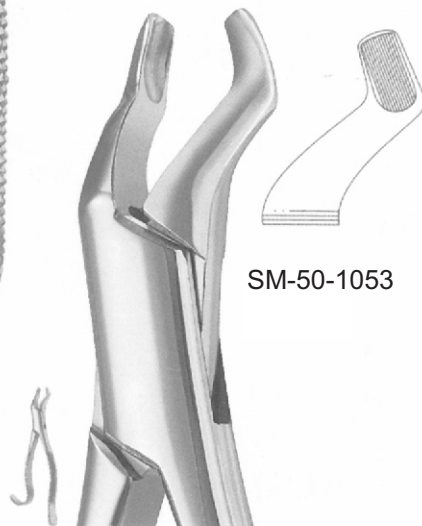
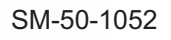

Fig.210 H

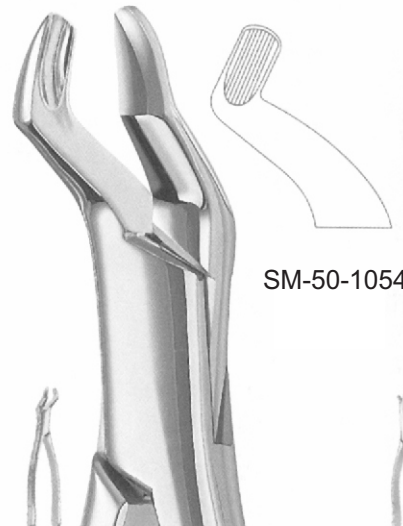

Fig.210 S

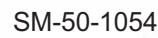
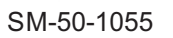

Fig.222



EXTRACTION



Fig. 286

Fig. 288



Fig.300

Fig.301

EXTRACTION

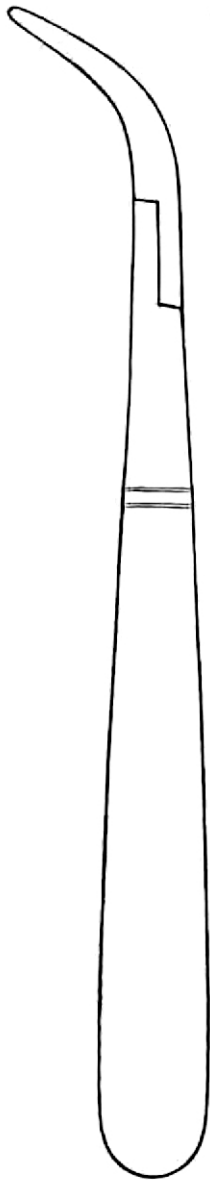

ZD-50-1061
WITZEL
Fig.501



ZD-50-1062
WITZEL
Fig.502

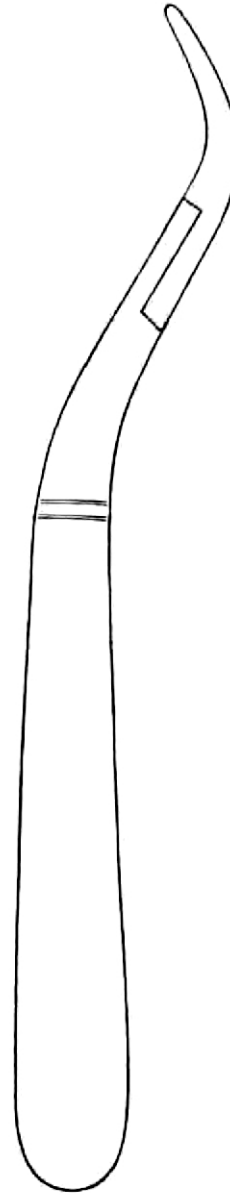



ZD-50-1063

Fig. 17 SK



ZD-50-1064

Fig. 23 SK



ZD-50-1065

Fig. 150 Sk



ZD-50-1066

Fig. 151 Sk

51

- EN** Extracting forceps, English pattern
- DE** Zahnzangen, Englische Form
- ES** Daviers, forme anglaise

Page 16 - 39

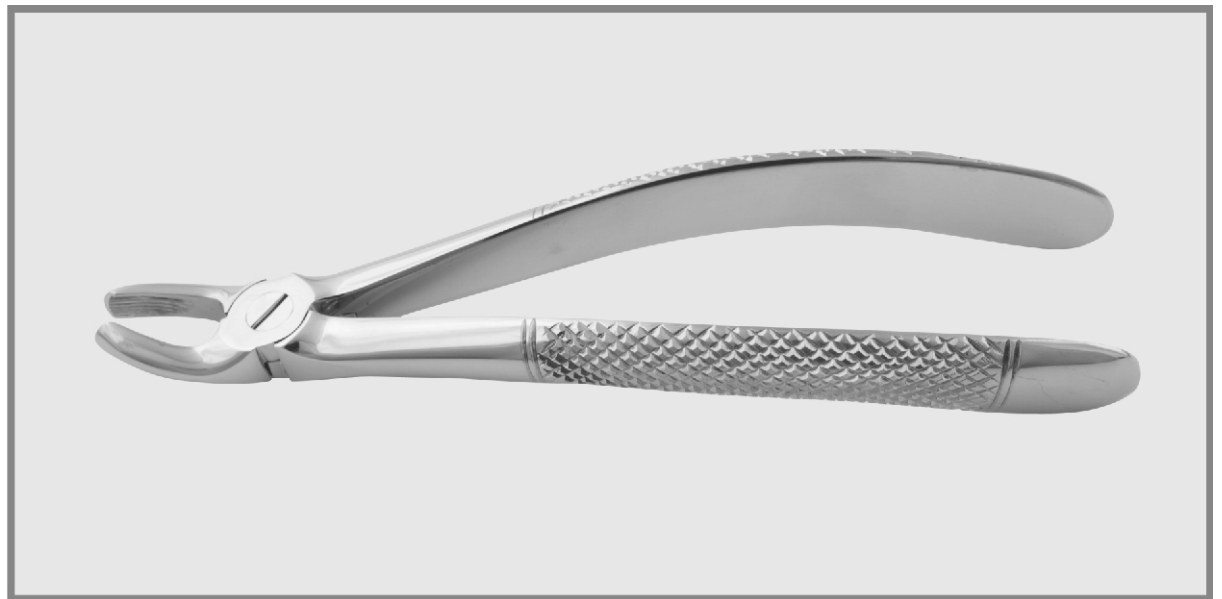
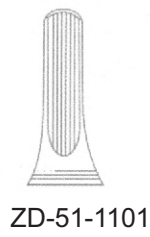



Fig. 1



ZD-51-1101

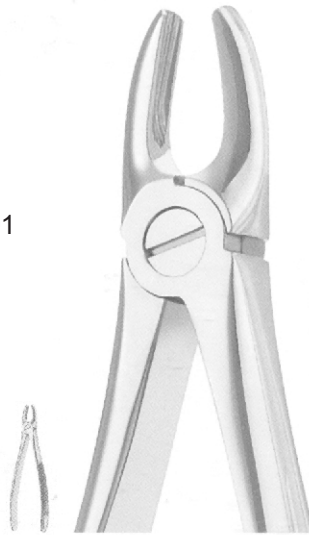
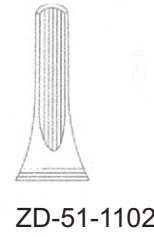

Fig. 2



ZD-51-1102



Fig. 3

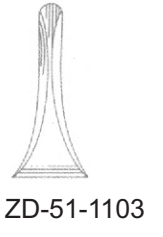

ZD-51-1103



Fig. 4

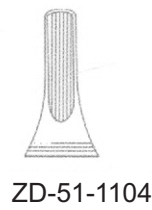

ZD-51-1104



Fig. 7

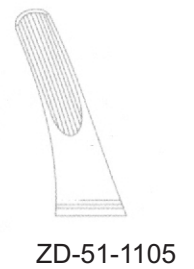

ZD-51-1105

EXTRACTION

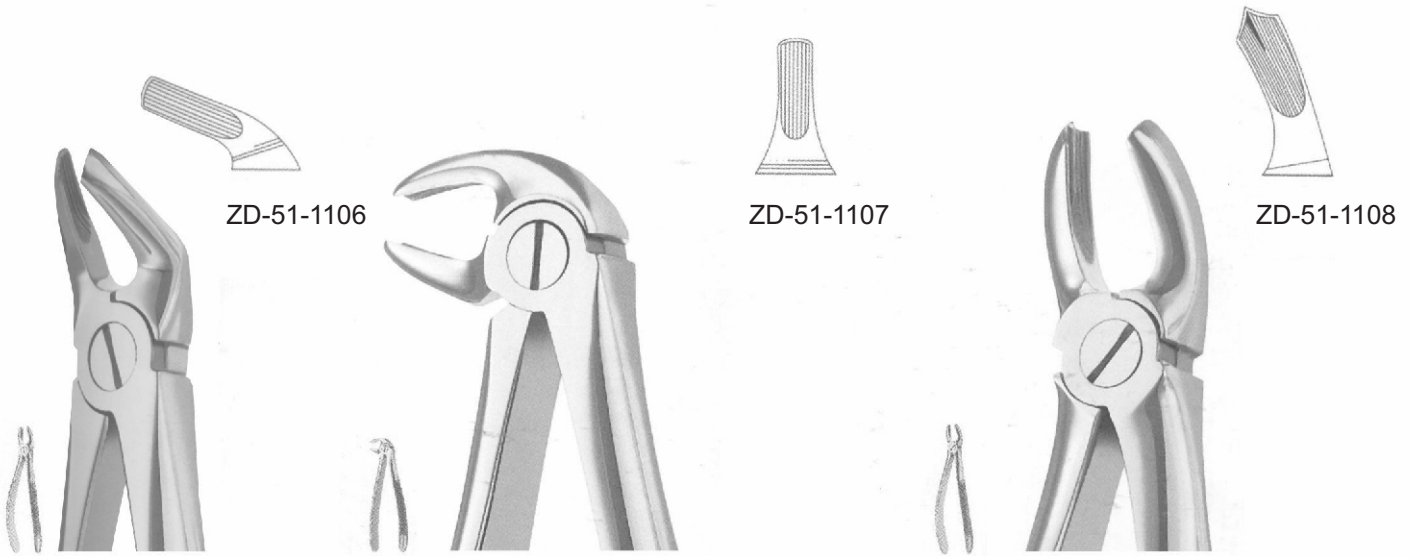

Fig. 8

Fig. 13

Fig. 17



Fig. 18

Fig. 18 A

Fig. 19



Fig. 20

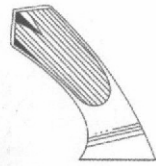

ZD-51-1112



Fig. 21

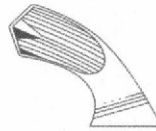

ZD-51-1113



Fig. 22



ZD-51-1114



Fig. 23

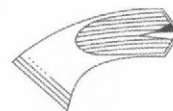

ZD-51-1115



Fig. 24

EXTRACTION



Fig. 29

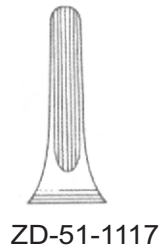

Fig. 29 N

ZD-51-1118

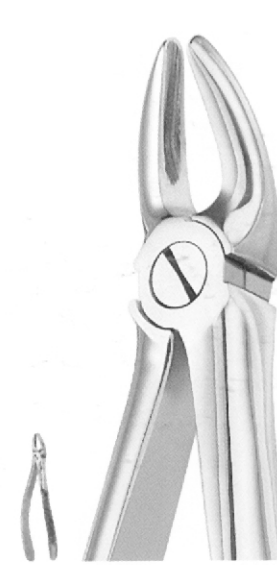

Fig. 30

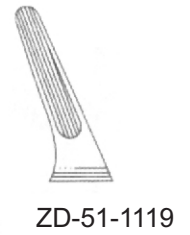

Fig. 31

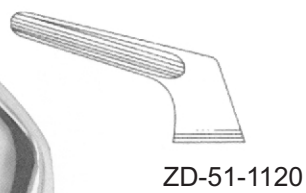

Fig. 32
 ZD-51-1121



Fig. 33

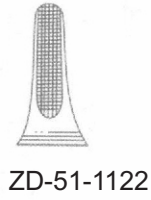

Fig. 33 A

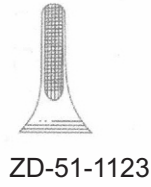

Fig. 33 C

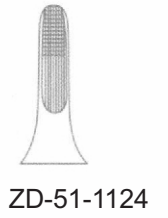

Fig. 33 M

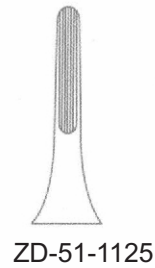
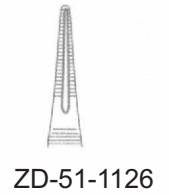

Fig. 33 W



EXTRACTION



Fig. 34



Fig. 35



Fig. 36



Fig. 41

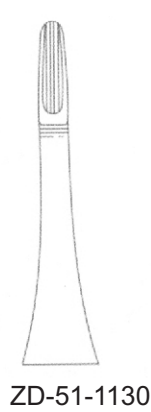

ZD-51-1130

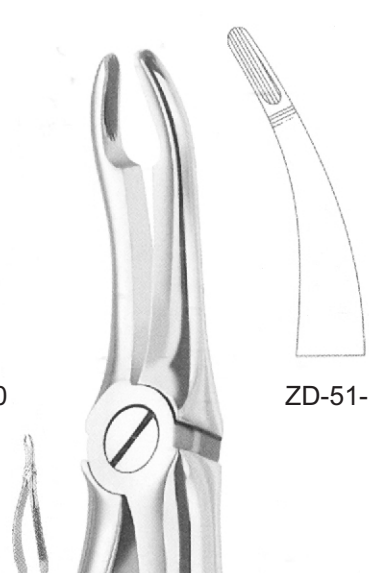

ZD-51-1131

Fig. 44

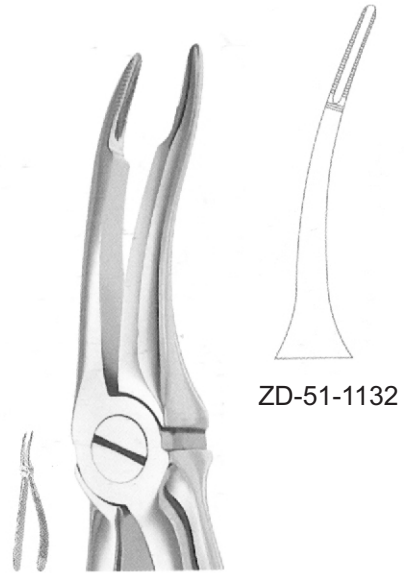

ZD-51-1132

Fig. 44 F

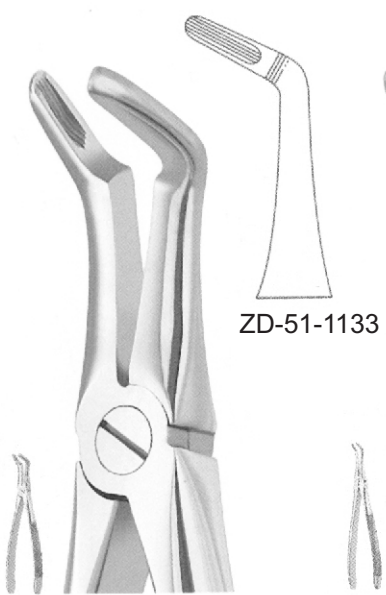

ZD-51-1133

Fig. 45

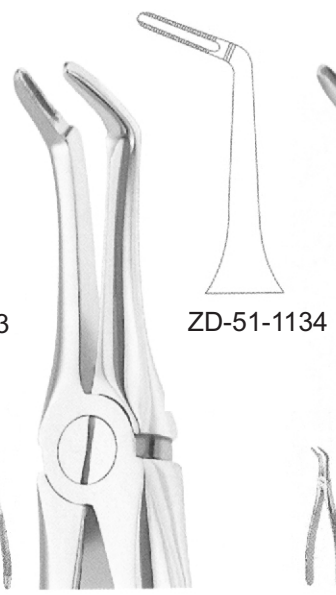

ZD-51-1134

Fig. 45 F

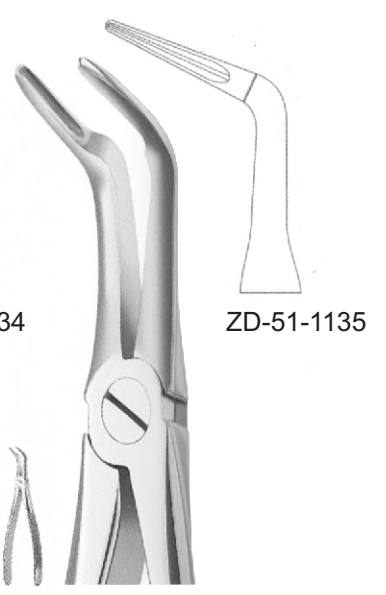

ZD-51-1135

Fig. 46 L

EXTRACTION



Fig. 51

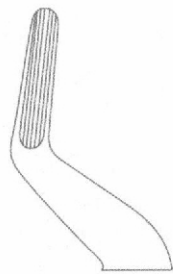

ZD-51-1136



Fig. 51 A

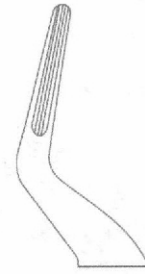

ZD-51-1137



Fig. 51 C

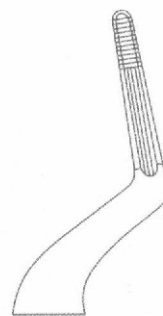

ZD-51-1138



Fig. 51 L

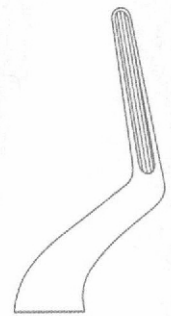

ZD-51-1139



ZD-51-1140

Fig. 51 M

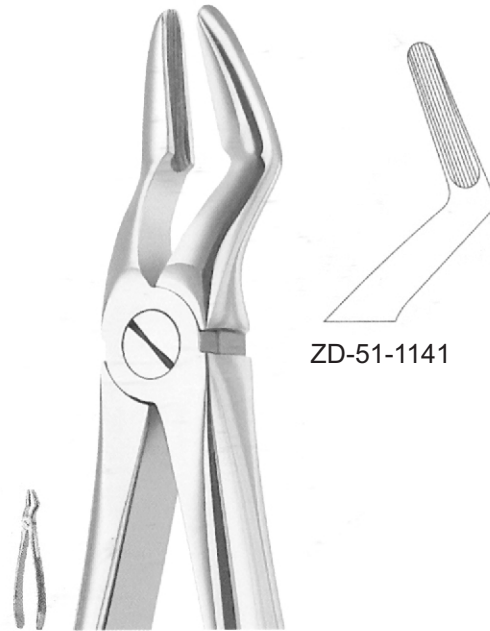

ZD-51-1141

Fig. 52

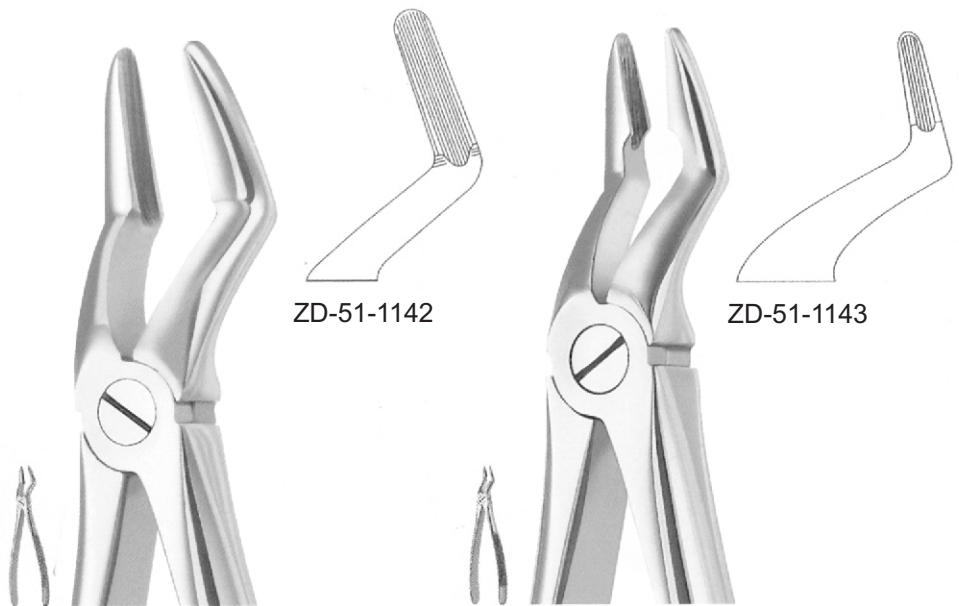

ZD-51-1142

ZD-51-1143

Fig. 52 A

Fig. 53

EXTRACTION



Fig. 55



ZD-51-1144

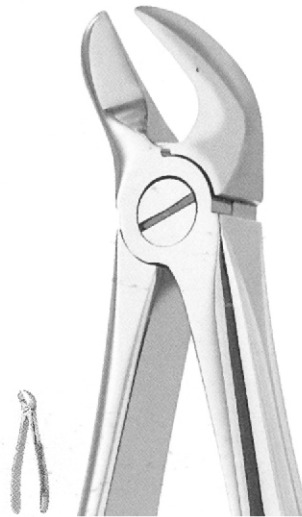
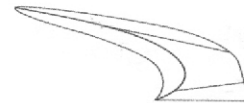
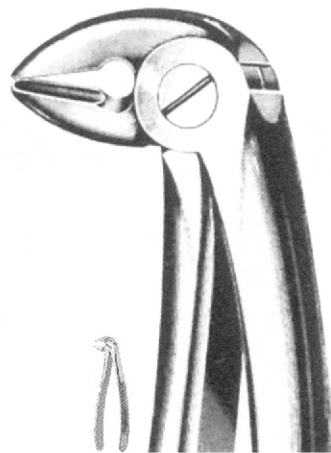

Fig. 56



ZD-51-1145



BUSCH
Fig. 59

breit
broad



ZD-51-1146



BUSCH
Fig. 60

schmal
narrow



ZD-51-1147

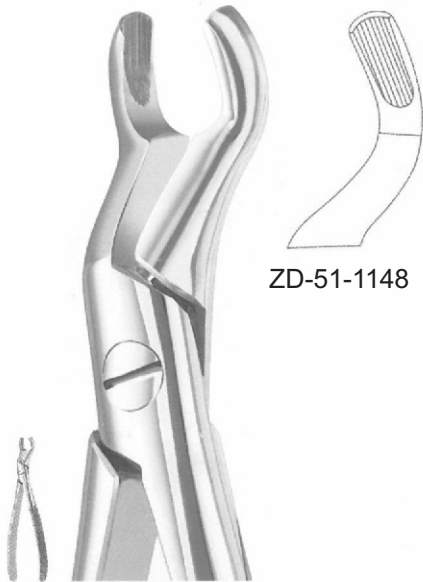

ZD-51-1148

Fig. 67

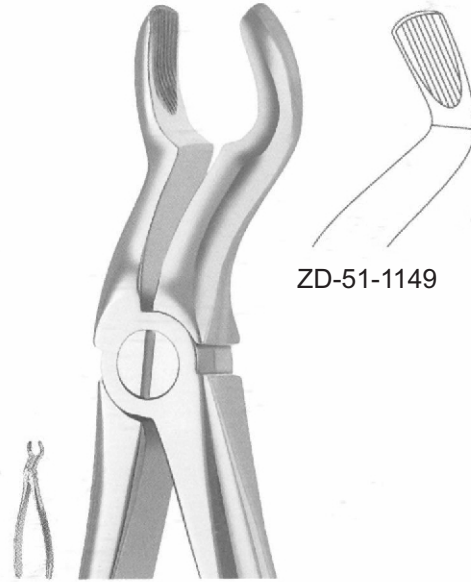

ZD-51-1149

Fig. 67 A

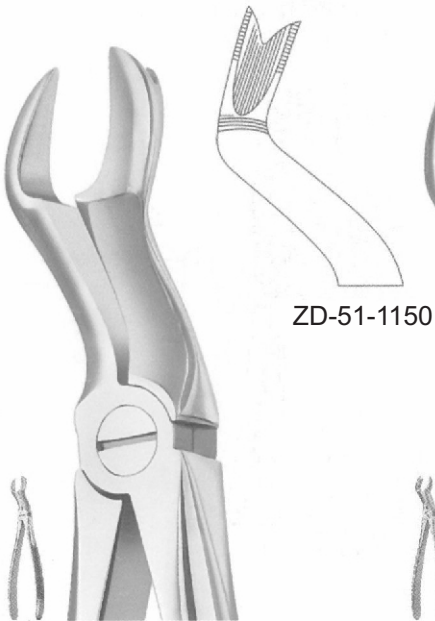

ZD-51-1150

Fig. 67 LX

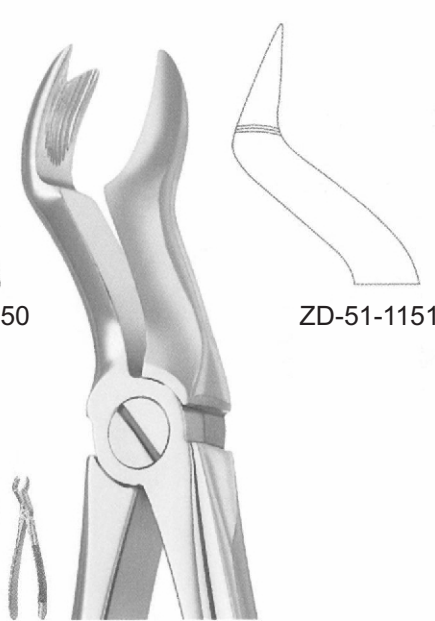

ZD-51-1151

Fig. 67 RX

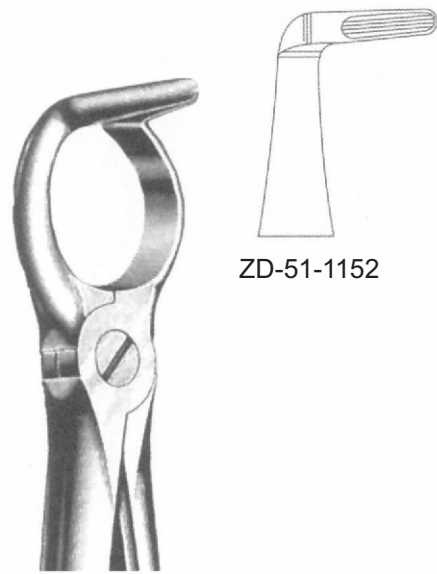

ZD-51-1152

RYDING
Fig. 68

EXTRACTION



Fig. 73



Fig. 74



Fig. 74 M



Fig. 74N



Fig. 75



ZD-51-1158

LAWRENCE-READ
Fig. 76



ZD-51-1159

LAWRENCE-READ
Fig. 76 N

EXTRACTION



Fig. 79

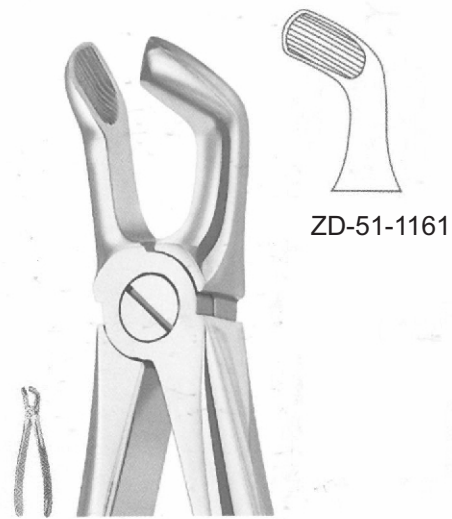

Fig. 79 A



Fig. 86 A



Fig. 86 B

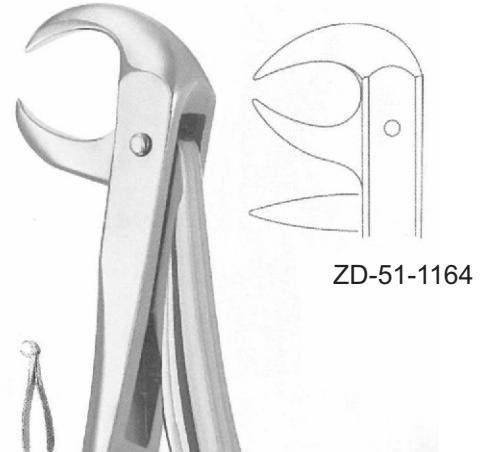

Fig. 86 C

EXTRACTION

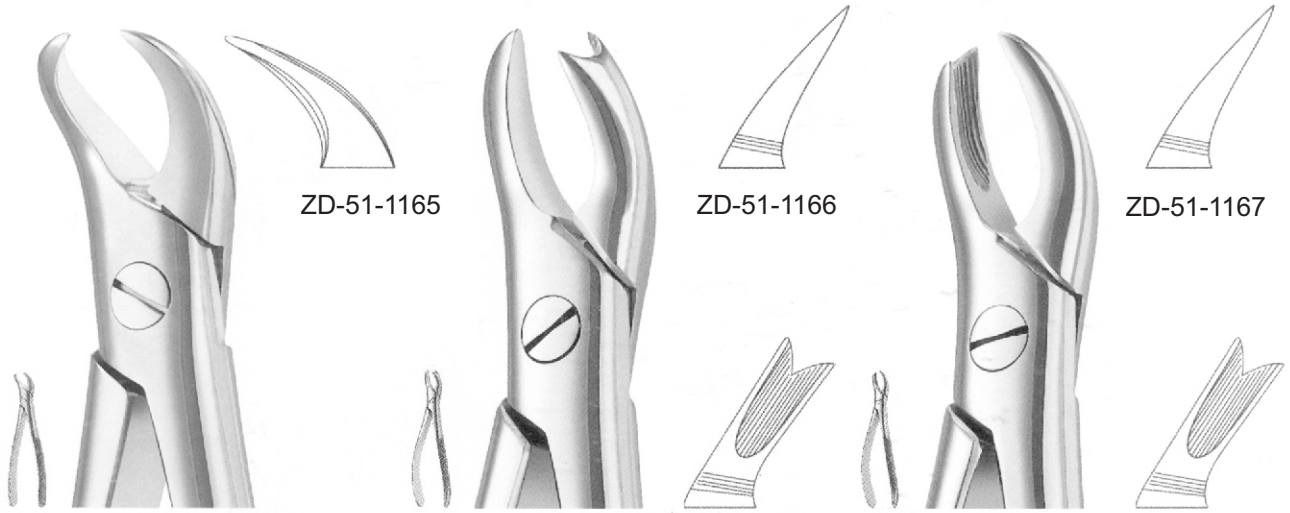

Fig. 87

Fig. 89

Fig. 90

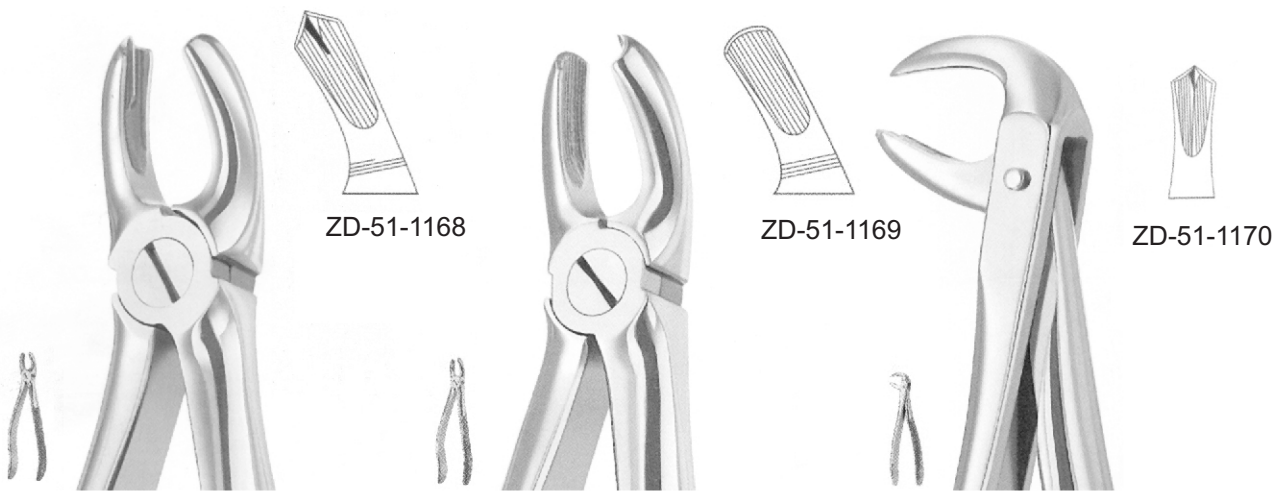

Fig. 94

Fig. 95

WOOD
Fig. 99

EXTRACTION



Fig. 113
ZD-51-1171

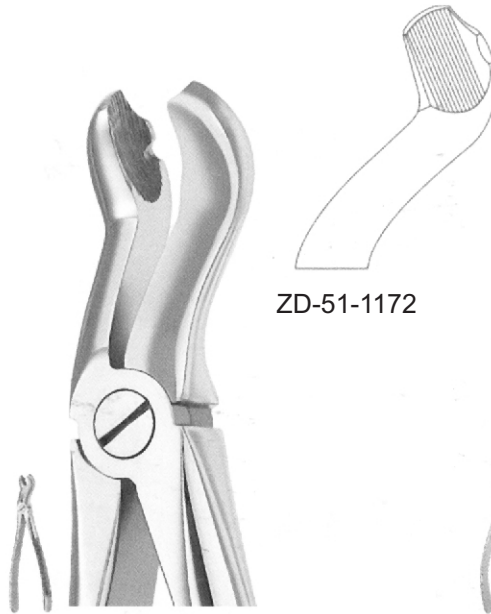

OGDEN FELSCH
Fig. 121



GUY
Fig. 136
ZD-51-1173



GUY
Fig. 137
ZD-51-1174



Fig. 160
ZD-51-1175



Fig. 162
ZD-51-1176



ZD-51-1177
Fig. 233



ZD-51-1178



ZD-51-1179
Fig. 235

EXTRACTION



MEAD
Fig. MD 1



ZD-51-1180

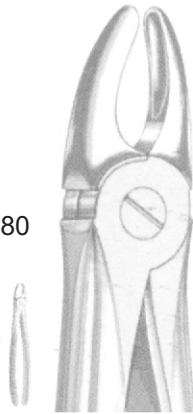

MEAD
Fig. MD 2



ZD-51-1181



MEAD
Fig. MD 3



ZD-51-1182



MEAD
Fig. MD 4



ZD-51-1183

EXTRACTION



COHEN



ZD-51-1184

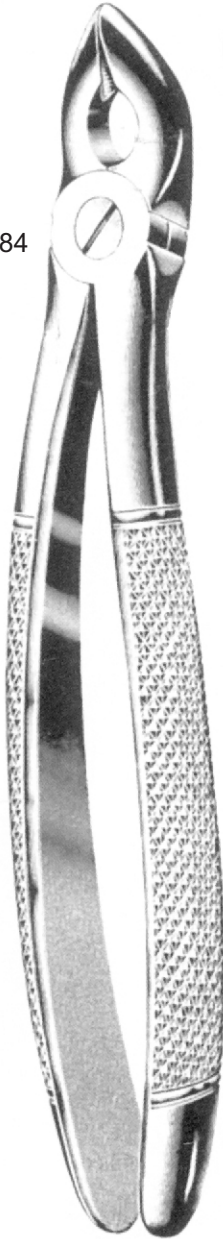

COHEN

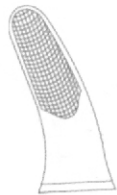

ZD-51-1185

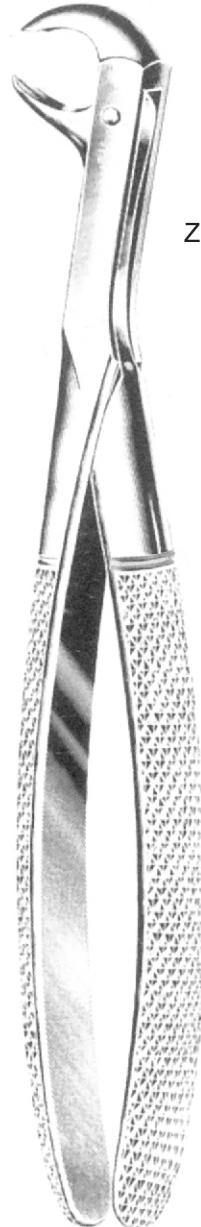

STIKSA



ZD-51-1186

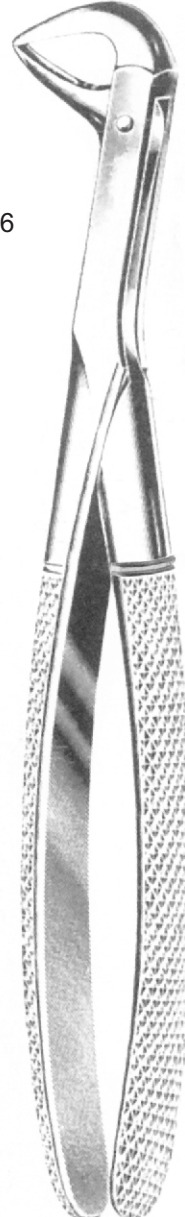

STIKSA



ZD-51-1187

EXTRACTION

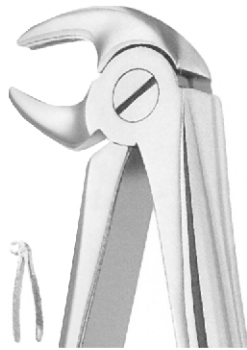

Fig. 13 S

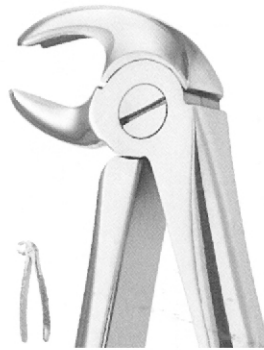

Fig. 22 S

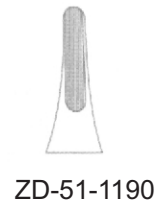
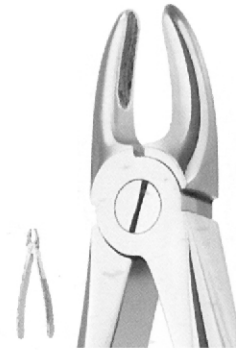

Fig. 29 S

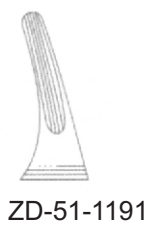

Fig. 30 S



Fig. 33 S

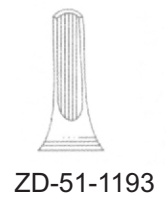

Fig. 37

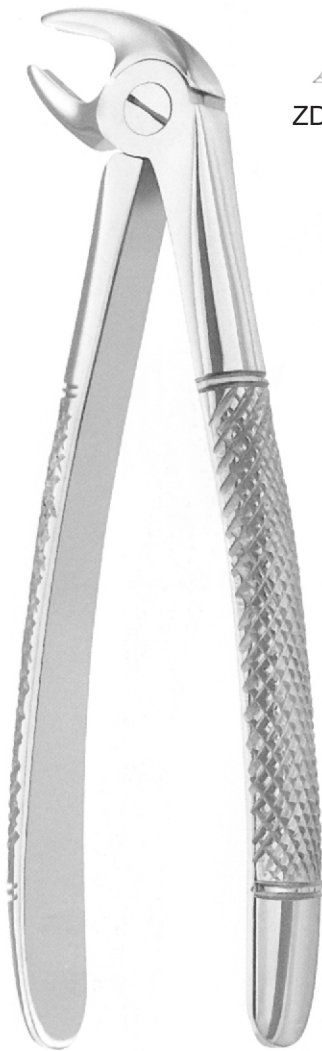

Fig. 38



Fig. 39

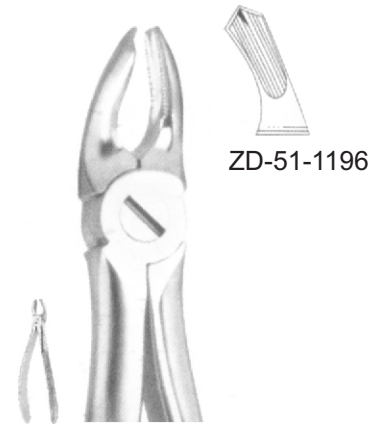

Fig. 39 A



Fig. 39 L



Fig. 39 R

EXTRACTION



ZD-51-1199

ZD-51-1200

Fig. 40

Fig. 51 S

ZD-51-1201
LAWRENCE-READ
Fig. 76 S

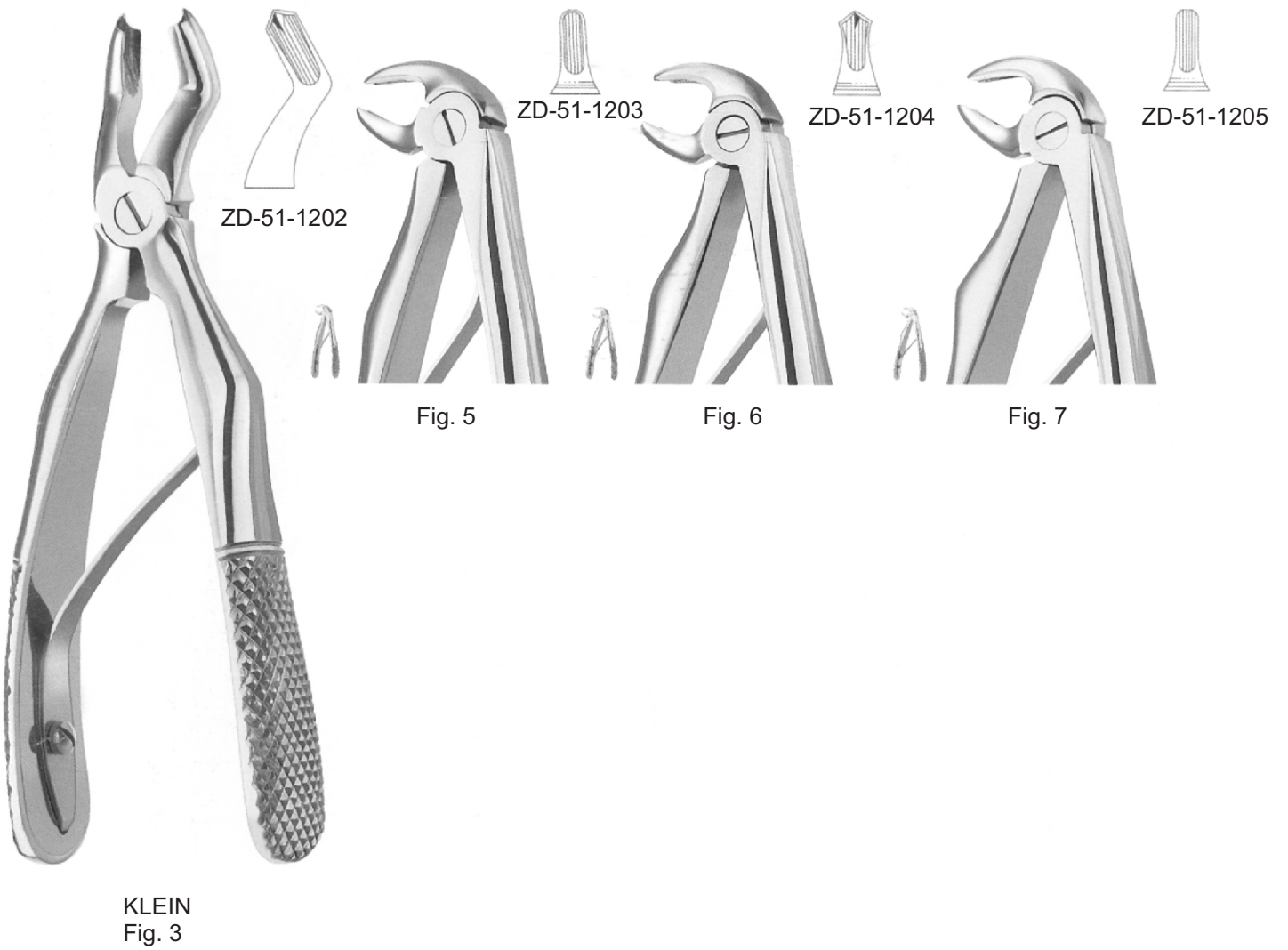

EXTRACTION



ZD-51-1206

KLEIN
 Fig. 137



ZD-51-1207

KLEIN
 Fig. 139



ZD-51-1208

KLEIN
 Fig. 51 S

52

- EN** Root Elevators
- DE** Wurzelheber
- ES** Elevateurs á racinesi

Page 40 to 54

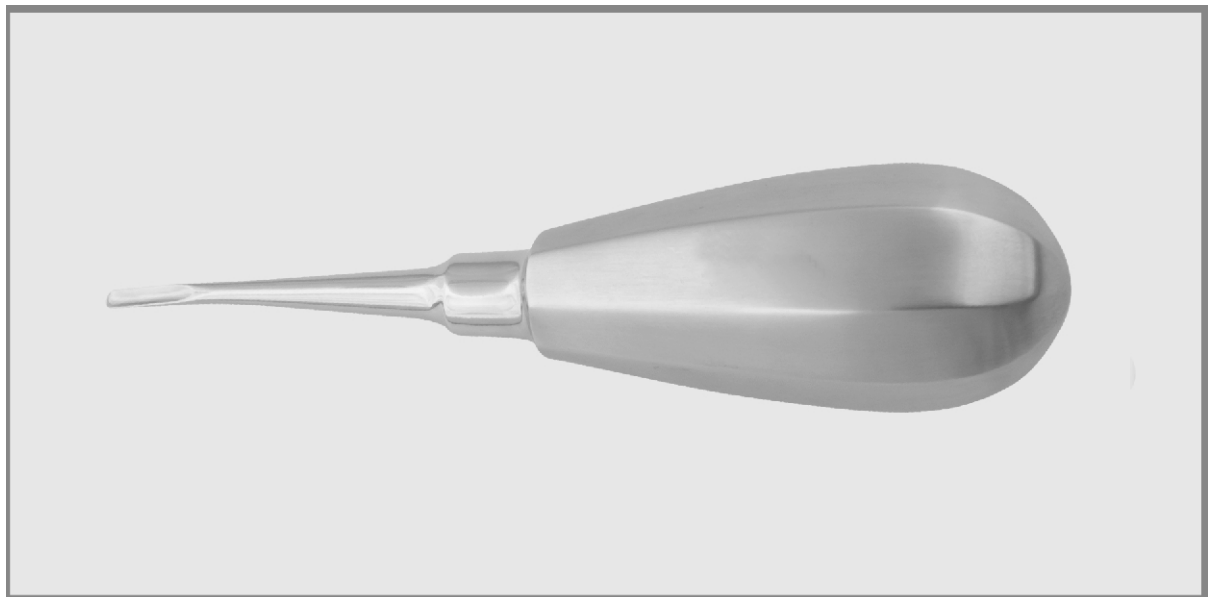

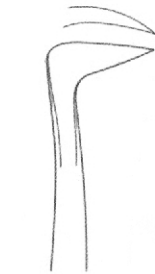

ZD-52-1251
Fig. 1 L



ZD-52-1252
Fig. 1 R



SALDIN
ZD-52-1253
Fig. 2



SELDIN
ZD-52-1254
Fig. 3

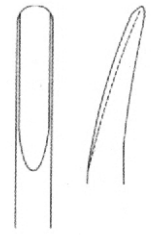

CRYER
ZD-52-1255
Fig. 3 A

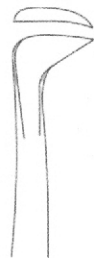

SELDIN
ZD-52-1256
Fig. 4 L



SELDIN
ZD-52-1257
Fig. 4 R



CRANE
(COGSWELL)
ZD-52-1258
Fig. 6

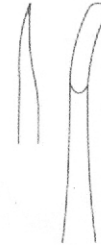

MILLER
ZD-52-1259
Fig. 8

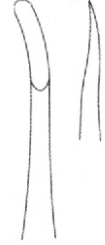

MILLER
ZD-52-1260
Fig. 9



MILLER (Apexo)
ZD-52-1261
Fig. 10



MILLER (Apexo)
ZD-52-1262
Fig.11

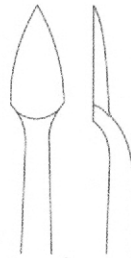

CRYER
ZD-52-1263
Fig. 12



CRYER
 ZD-52-1264
 Fig. 27



CRYER
 ZD-52-1265
 Fig. 28



CRYER
 ZD-52-1266
 Fig. 27 S



CRYER
 ZD-52-1267
 Fig. 28 S



SELDIN
 ZD-52-1268
 Fig. 34

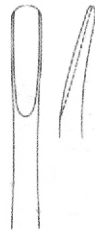

SELDIN
 ZD-52-1269
 Fig. 34 S



CRYER
 ZD-52-1270
 Fig. 39



CRYER
 ZD-52-1271
 Fig. 40



FLOHR
 ZD-52-1272
 Fig. 46



ZD-52-1273
 Fig. 50



ZD-52-1274
 Fig. 51

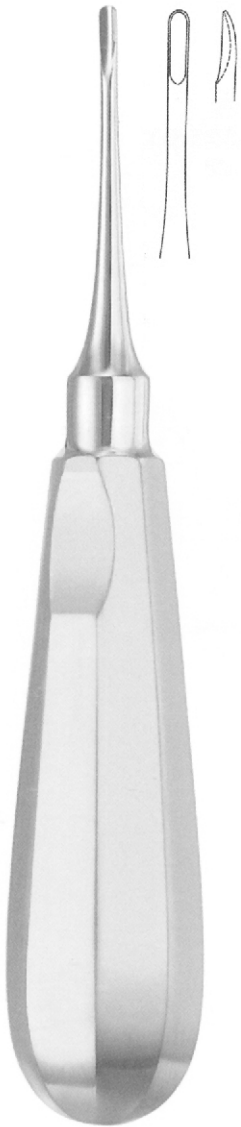

APICAL (Apexo)
 ZD-52-1275
 Fig. 301

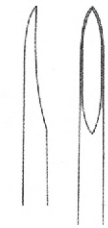

ZD-52-1276
 Fig. 304

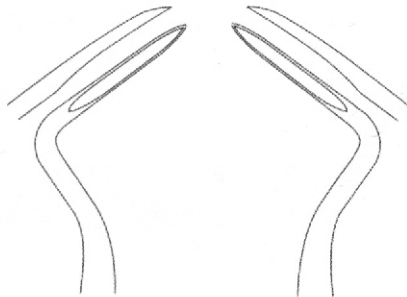

ZD-52-1277
 Fig. 302

FLOHR
 ZD-52-1278
 Fig. 303



COLEMAN



ZD-52-1279
 Fig. 1



ZD-52-1280
 Fig. 2 L

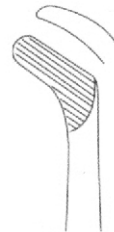

ZD-52-1281
 Fig. 3 R



WARWICK JAMES
 ZD-52-1282
 16 cm/6 1/4"



ZD-52-1283
 Fig. 2 L



ZD-52-1284
 Fig. 3 L



KOPP



ZD-52-1285
 Fig. 1



ZD-52-1286
 Fig. 2



ZD-52-1287
 Fig. 3



ZD-52-1288
 Fig. 4



KOPP



ZD-52-1289
Fig. 1



ZD-52-1290
Fig. 2



ZD-52-1291
Fig. 3



ZD-52-1292
Fig. 4

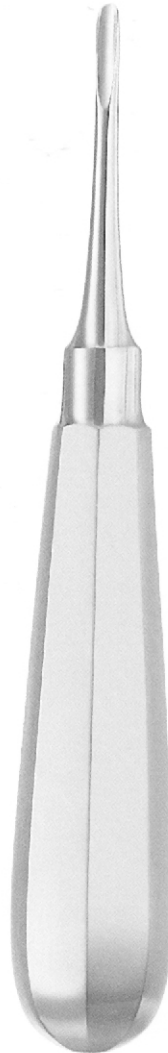

FLOHR



ZD-52-1293
Fig. 1



ZD-52-1294
Fig. 2



ZD-52-1295
Fig. 3



FRIEDMAN
 ZD-52-1296
 Fig 1

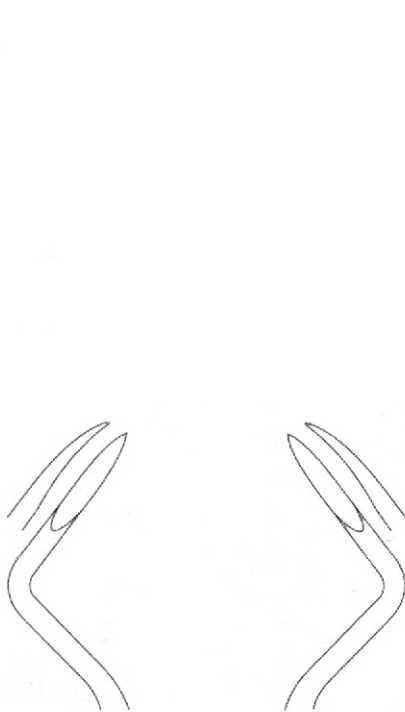

ZD-52-1297
 Fig. 2 L

ZD-52-1298
 Fig. .3 R



HYLIN
 ZD-52-1299
 Fig. 1

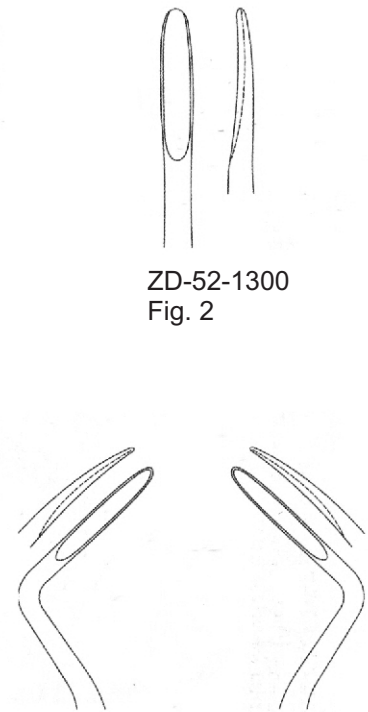

ZD-52-1300
 Fig. 2

ZD-52-1301
 Fig. 3 L

ZD-52-1302
 Fig. 4 R



2 mm



ZD-52-1303
Fig.0

3 mm

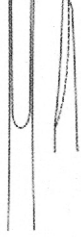

BEIN
ZD-52-1304
Fig. 1

4 mm



ZD-52-1305
Fig. 2

2 mm



ZD-52-1306
Fig. 0

3 mm

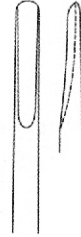

BEIN
ZD-52-1307
Fig. 1

4 mm

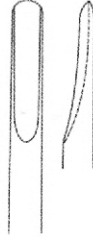

ZD-52-1308
Fig. 2

2 mm



ZD-52-1309
Fig. 0

3 mm



BEIN
ZD-52-1310
Fig. 1

4 mm

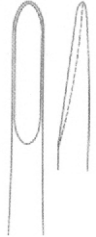

ZD-52-1311
Fig. 2

2 mm

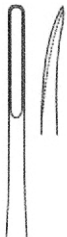

ZD-52-1312
Fig. 0 A

3mm



BEIN
ZD-52-1313
Fig. 1 A

4 mm

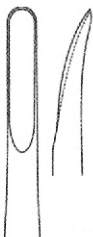

ZD-52-1314
Fig.2 A

2 mm



ZD-52-1315
Fig.0 A

3 mm



BEIN
ZD-52-1316
Fig. 1 A

4 mm

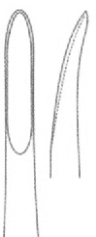

ZD-52-1317
Fig. 2 A

ROOT ELEVATORS

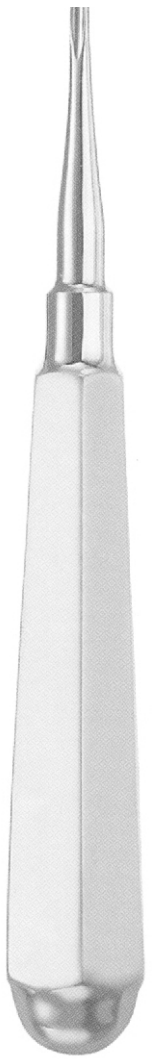

COUPLAND

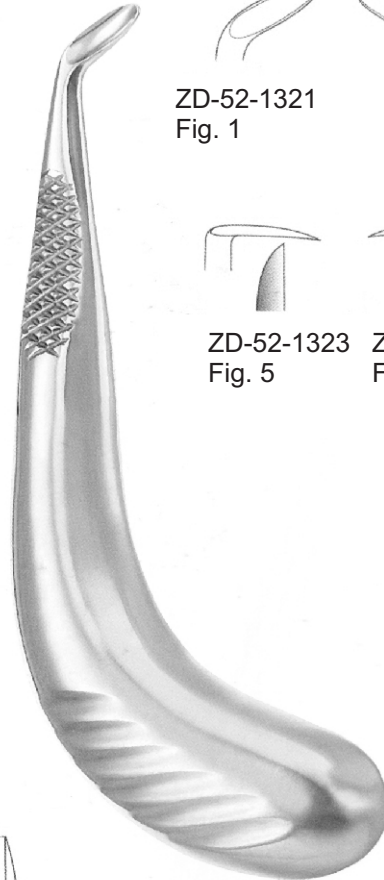
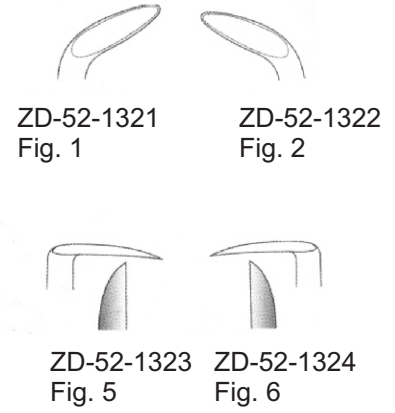
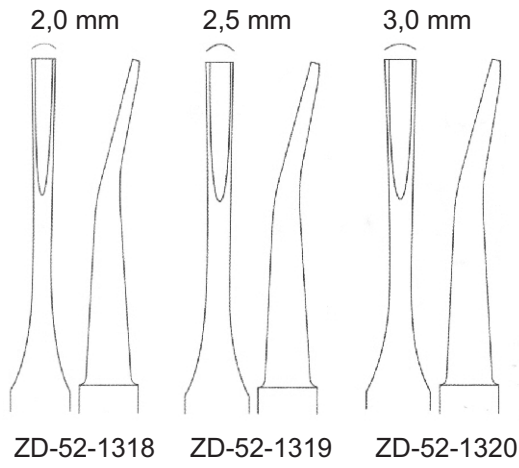

LOOS

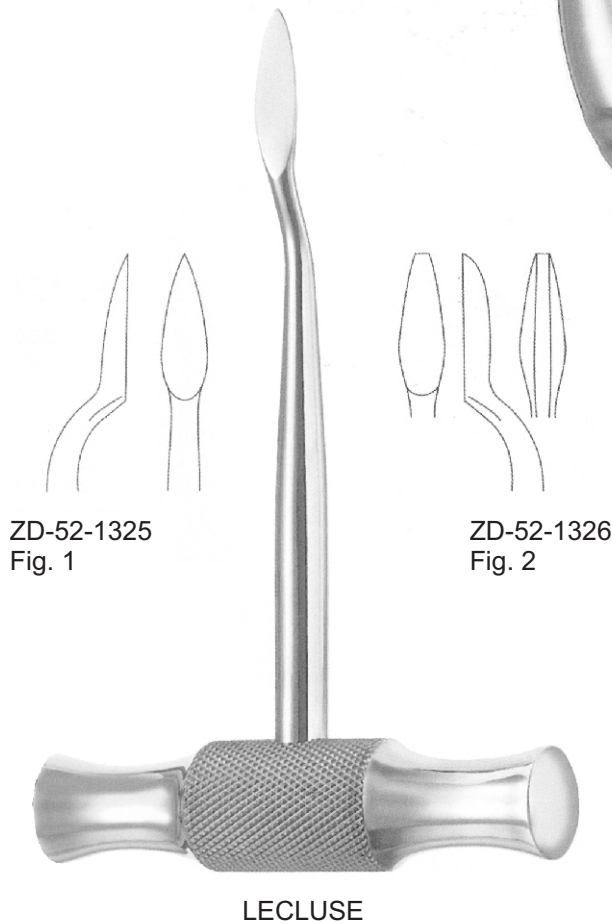

LECLUSE



BARRY
 11 cm/4 1/4"



ZD-52-1327
 Fig. 320 L



ZD-52-1328
 Fig. 321 R



ZD-52-1329
 Fig. 322



ZD-52-1330
 Fig. 323

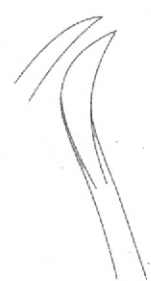

ZD-52-1331
 Fig. 370



ZD-52-1332
 Fig.371



ZD-52-1333
Fig. 1 L



ZD-52-1334
Fig. 1 R



ZD-52-1335
Fig. 11 L



ZD-52-1336
Fig. 11 R



ZD-52-1337
Fig. 12 L



ZD-52-1338
Fig. 12 R



WINTER
11 cm/4 1/4"

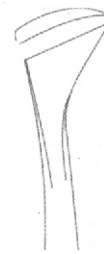

ZD-52-1339
Fig. 13 L



ZD-52-1340
Fig. 13 R



ZD-52-1341
Fig. 14 L



ZD-52-1342
Fig. 14 R



CHOMPRET

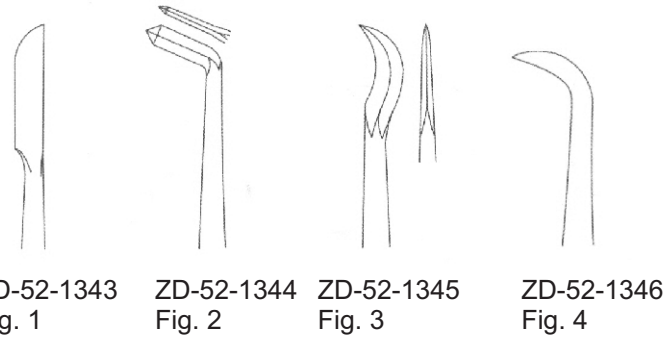

ZD-52-1343 Fig. 1 ZD-52-1344 Fig. 2 ZD-52-1345 Fig. 3 ZD-52-1346 Fig. 4

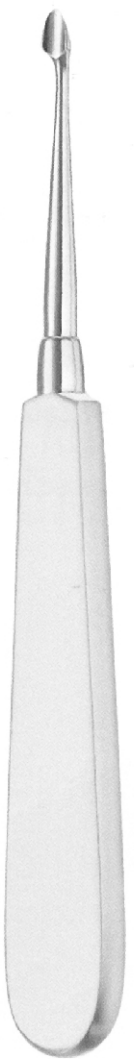

BERNARD

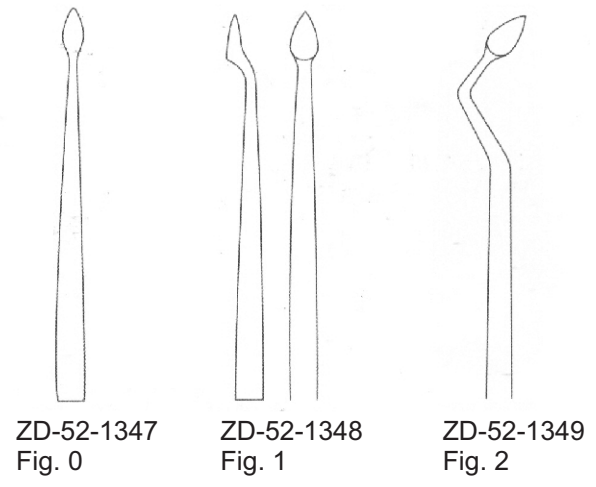

ZD-52-1347 Fig. 0 ZD-52-1348 Fig. 1 ZD-52-1349 Fig. 2

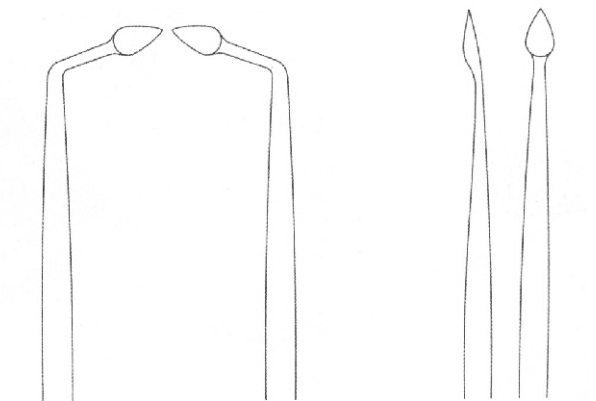

ZD-52-1350 Fig. 6 ZD-52-1351 Fig. 7 ZD-52-1352 Fig. 11

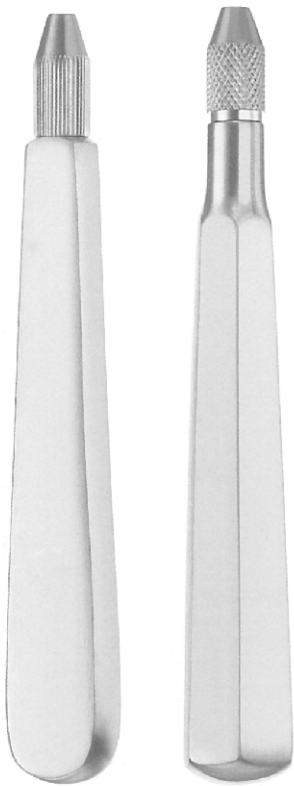

BERNARD
Handle # A

BERNARD
Handle # B



ZD-52-1353
Fig. 1



ZD-52-1354
Fig. 2



ZD-52-1355
Fig. 3



ZD-52-1356
Fig. 4



ZD-52-1357
Fig. 5



ZD-52-1358
Fig. 10

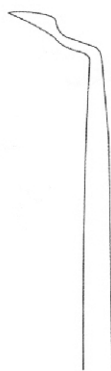

ZD-52-1359
Fig. 8



ZD-52-1360
Fig. 9

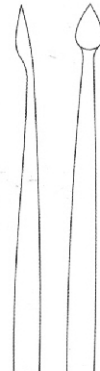

ZD-52-1361
Fig. 11

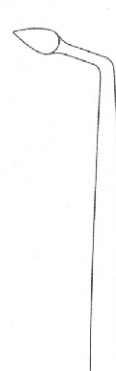

ZD-52-1362
Fig. 7



ZD-52-1363
Fig. 6



HEIDBRINK

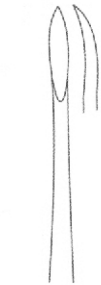

ZD-52-1366
Fig. 1



ZD-52-1367
Fig. 2



ZD-52-1368
Fig. 3



WEST (Apical)



ZD-52-1369
Fig. 1

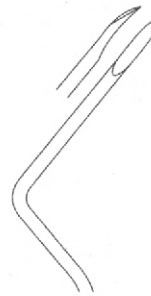

ZD-52-1370
Fig. 2 R

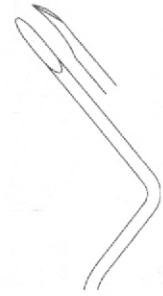

ZD-52-1371
Fig. 3 L



RATZOW

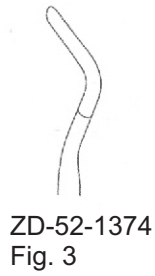
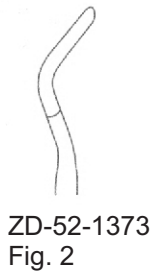
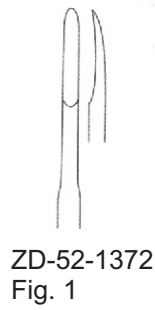

HEIDBRINK

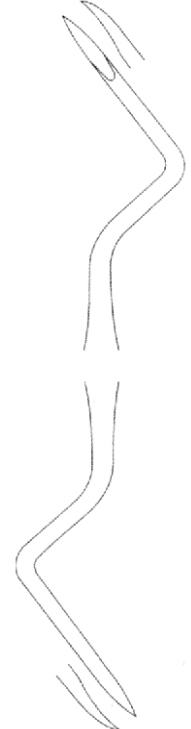
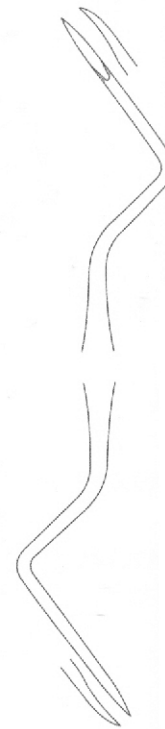
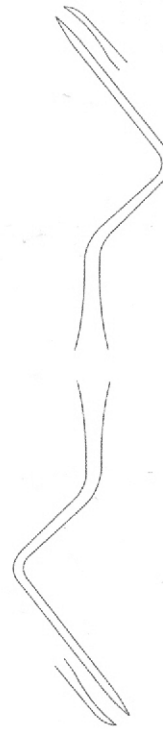

ROOT ELEVATORS

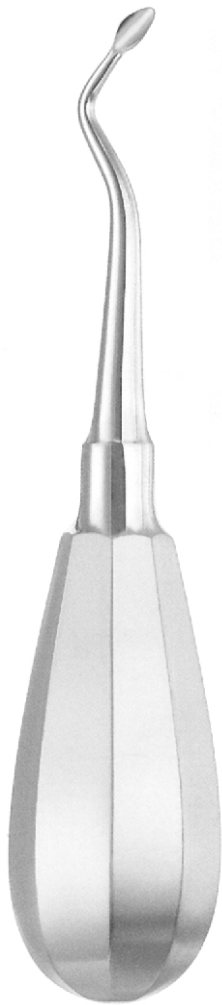

VIGNAL

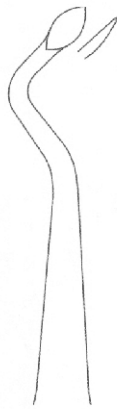

ZD-52-1378
Fig. 54



ZD-52-1379
Fig. 55



ZD-52-1380
Fig.56



ZD-52-1381
Fig.57



ZD-52-1382
Fig. 69

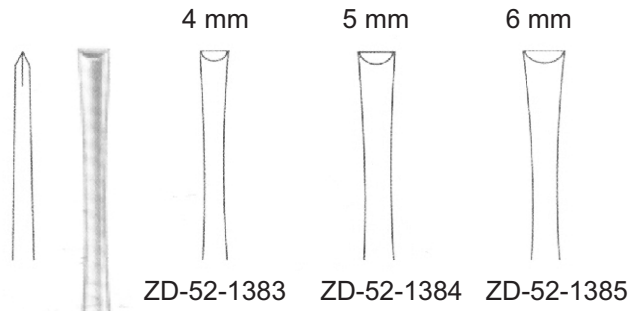

ZD-52-1383

ZD-52-1384

ZD-52-1385

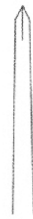

BARRY
21.5 cm/8 3/4"

53

- EN** Bone Files
- DE** Bone-Dateien
- ES** Archivos de huesos

Page 55 to 56

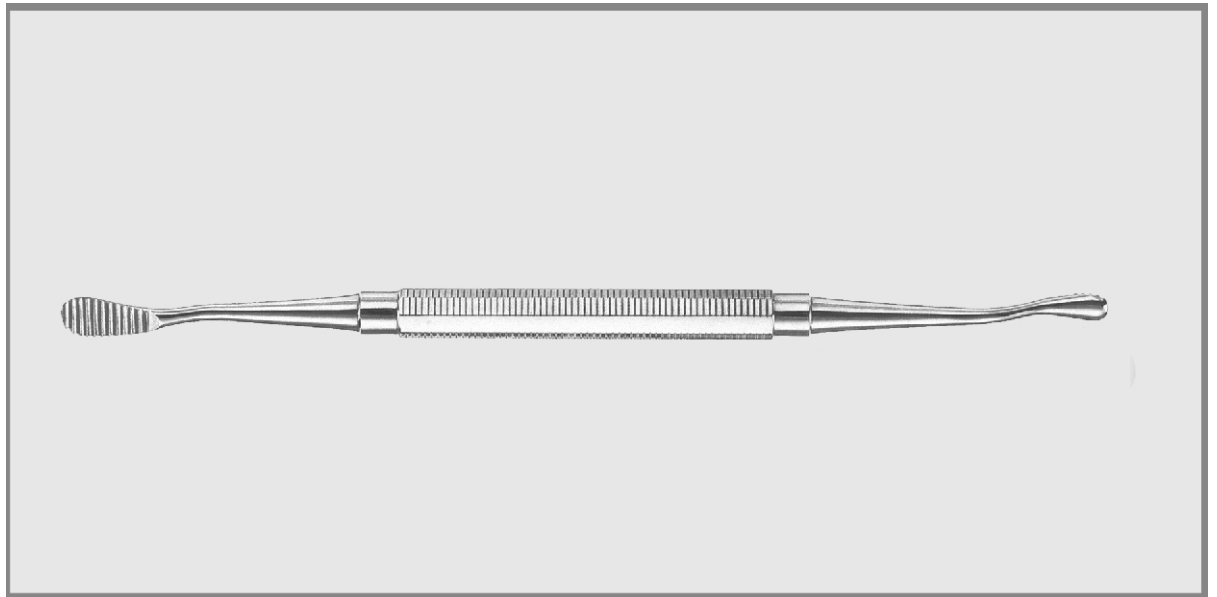



downwards cutting

MILLER-COLBURN
 18 cm/7"

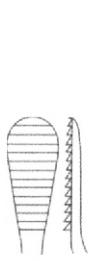
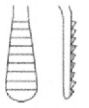

Fig. 1



ZD-53-1401

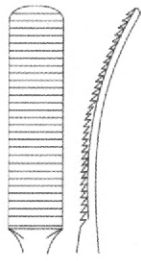
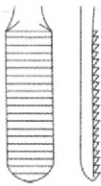

Fig. 2



ZD-53-1402

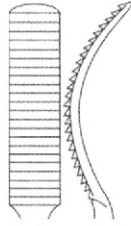
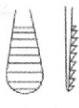

Fig. 3



ZD-53-1403

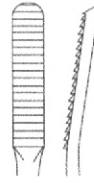
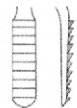

Fig. 4



ZD-53-1404

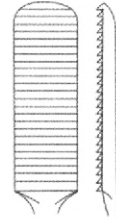
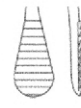

Fig. 5



ZD-53-1405

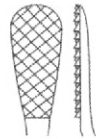

Fig. 1



ZD-53-1406

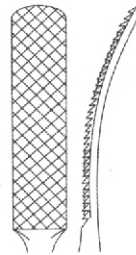
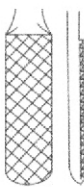

Fig. 2



ZD-53-1407

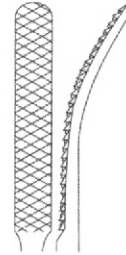
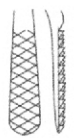

Fig. 3



ZD-53-1408



Fig. 4



ZD-53-1409

cross cut



MILLER-COLBURN
 18 cm/7"

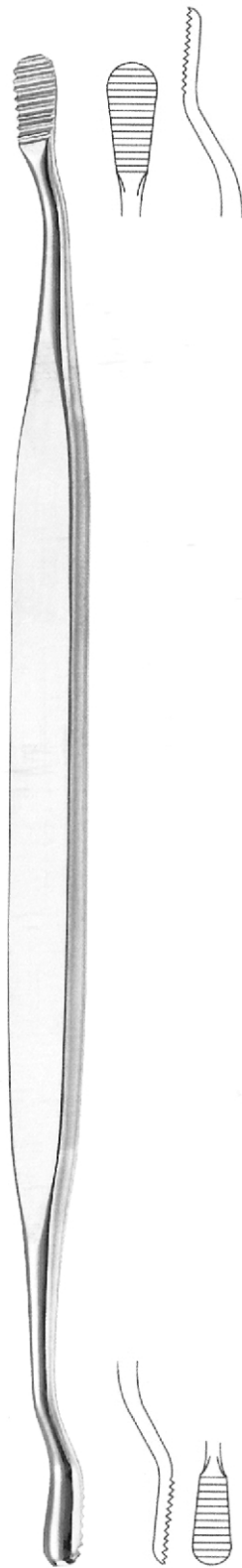

SELDIN
ZD-53-1410
18 cm/7"
Fig. 11

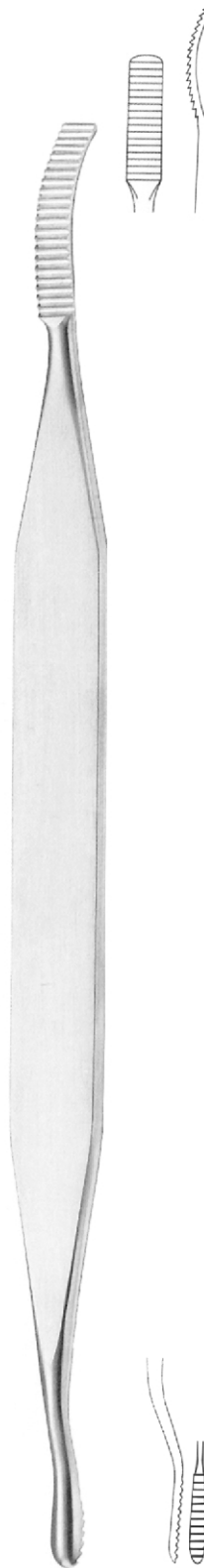

SELDIN
ZD-53-1411
18 cm/7"
Fig. 12

54

- EN** Dental Probes
- DE** Zahnsonden
- ES** Sondas dentales

Page 57 to 58

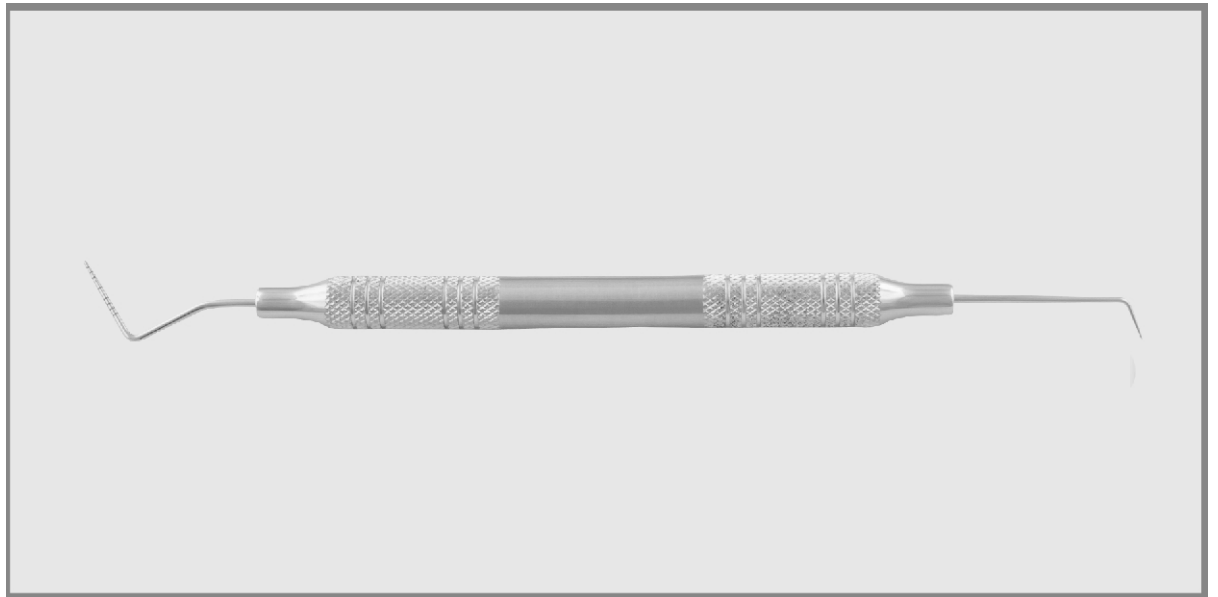

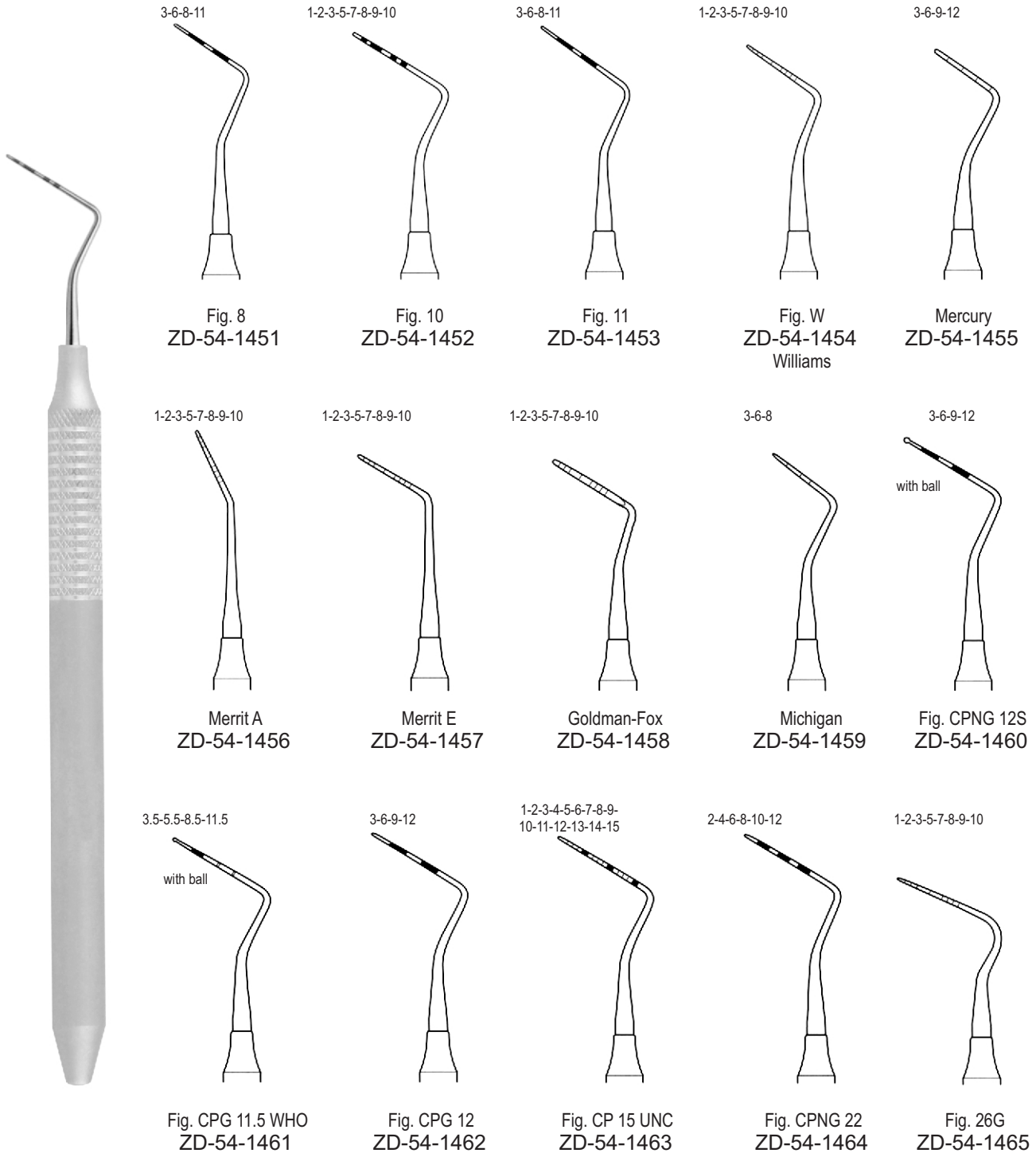

DENTAL PROBES

1-2-3-5-7-8-9-10
FLAT



Goldman-Fox
Williams
ZD-54-1466

3-6-9-12

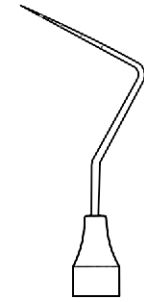

Fig. UT 3/4
Cattoni
ZD-54-1467



12-9-6-3

1-2-3-5-7-8-9-10
FLAT

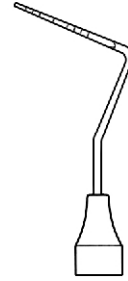
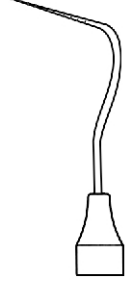

Fig. 3N
Nabers
ZD-54-1468



10-9-8-7-5-3-2-1

1-2-3-5-7-8-9-10



Williams DE
Offset
ZD-54-1469



10-9-8-7-5-3-2-1

3-6-9-12

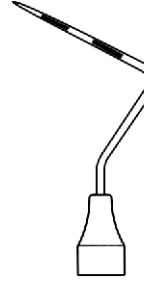
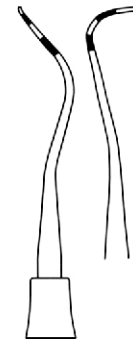

Fig. CP 12/Thin
Williams
ZD-54-1470



10-9-8-7-5-3-2-1



Nabers Furcation
probes graduated
working end
ZD-54-1471



55

- EN** Enamel Instruments
- DE** Emaille-Instrumente
- ES** Instrumentos de esmalte

Page 59 to 62

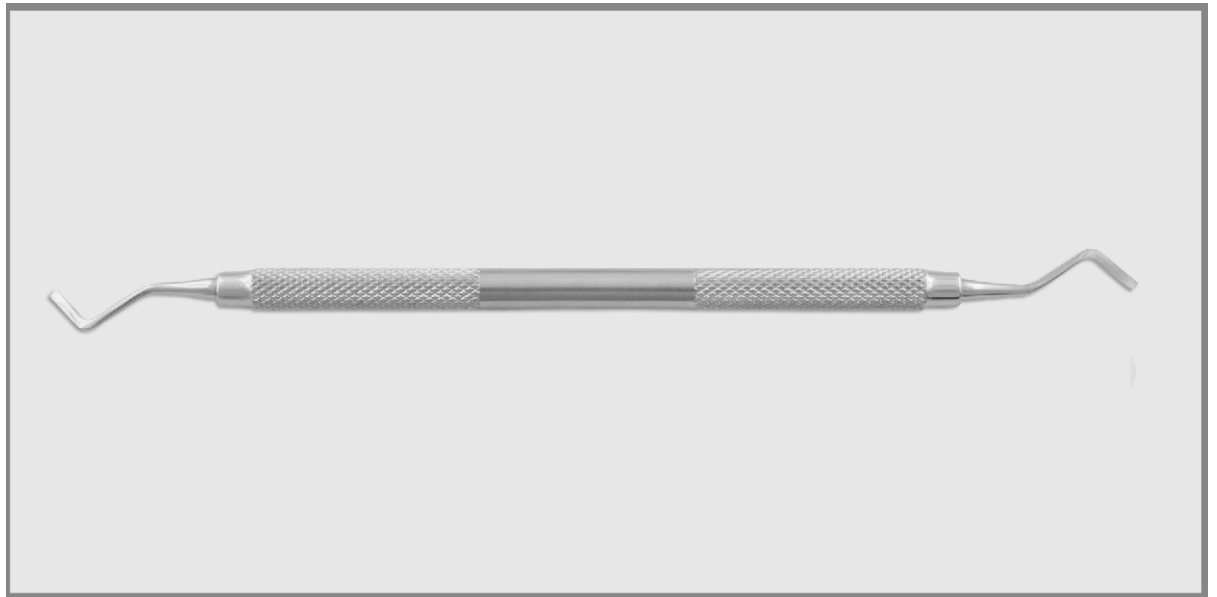



ZD-55-1501
 Fig. 1
 Black



ZD-55-1502
 Fig. 2
 Black



ZD-55-1503
 Fig. 26
 Black



ZD-55-1504
 Fig. 27
 Black



ZD-55-1505
 Fig. 28
 Black



ZD-55-1506
 Fig. 29
 Black





ZD-55-1507
 Fig. 51/52
 Black



ZD-55-1508
 Fig. 53/54
 Black



ZD-55-1509
 Fig. 63/64
 Black



ZD-55-1510
 Fig. 65/66
 Black



ZD-55-1511
 Fig. 1/2
 Wedelstaedt



ZD-55-1512
 Fig. 3/4
 Wedelstaedt



ZD-55-1513
 Fig. 5/6
 Wedelstaedt

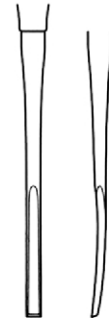



ZD-55-1514
Fig. 8/9H



ZD-55-1515
Fig. 13/14



ZD-55-1516
Fig. 15/16



ZD-55-1517
Fig. 17/18



ZD-55-1518
Fig. 51/52



ZD-55-1519
Fig. 53/54



ZD-55-1520
Fig. 14/14
Off Angle



ENAMEL INSTRUMENTS



ZD-55-1521
 Fig. 26
 Distal



ZD-55-1522
 Fig. 27
 Mesial



ZD-55-1523
 Fig. 28
 Distal



ZD-55-1524
 Fig. 29
 Mesial



ZD-55-1525
 Fig. 77/78
 Distal



ZD-55-1526
 Mesial
 54-1142-00



56

- EN** Dental Scalers
- DE** Zahnsteinentferner
- ES** Escaladores dentales

Page 63 to 78

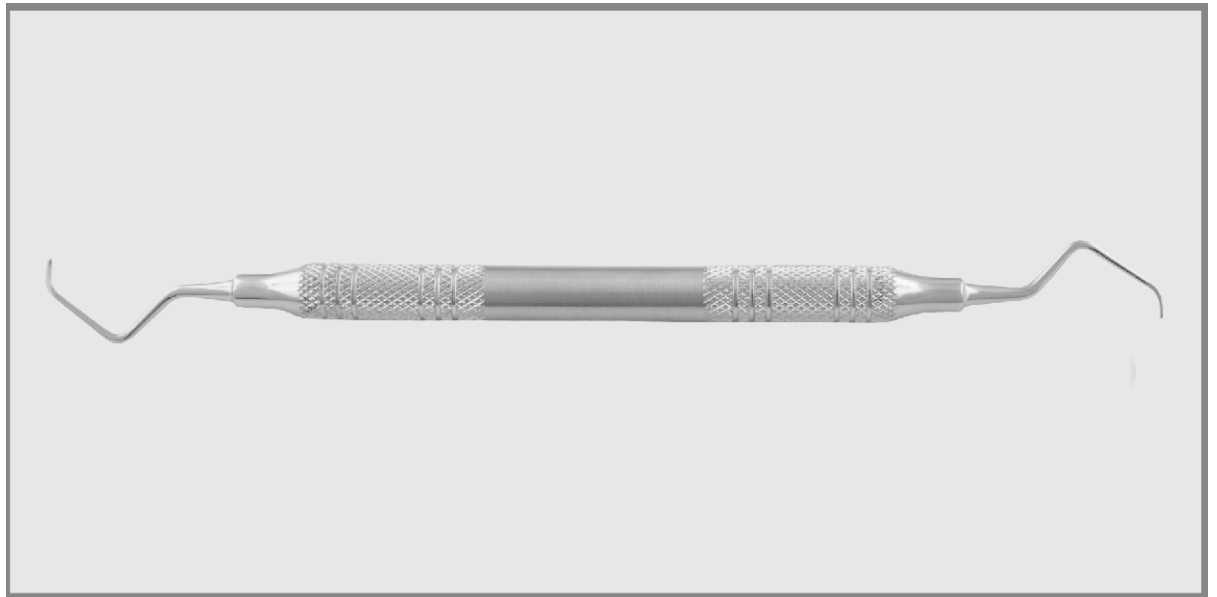

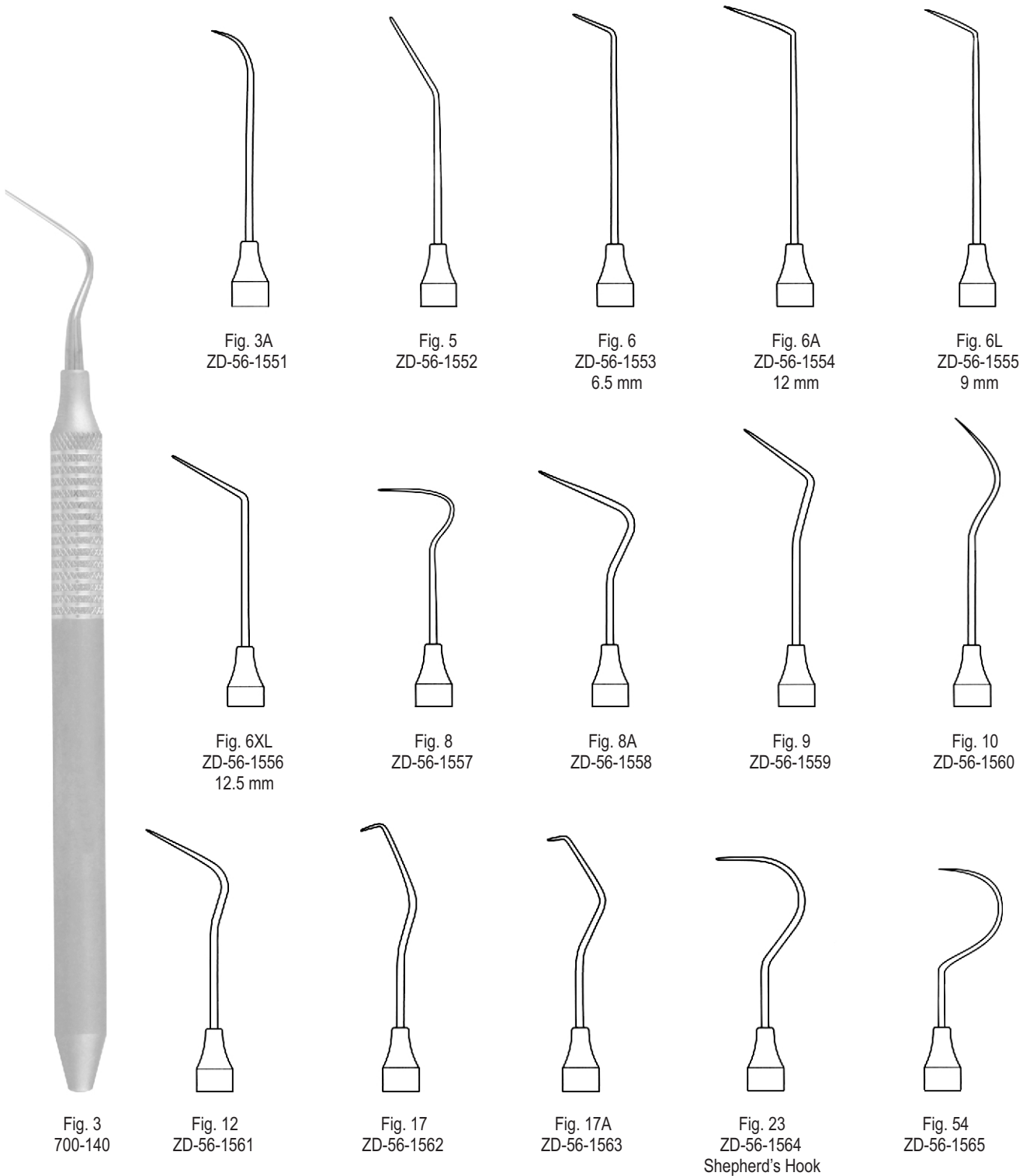



Fig. UT 1/2
 ZD-56-1566

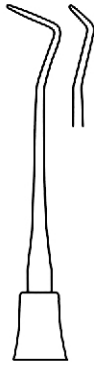

Fig. UT 2/2
 ZD-56-1567

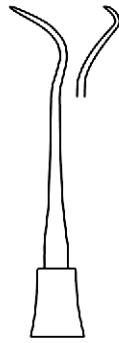

Fig. 3CH/3CH
 ZD-56-1568



Fig. 6/3
 ZD-56-1569



Fig. 16/3
 ZD-56-1570



Fig. 2
 ZD-56-1571

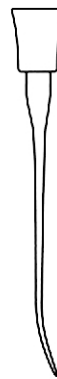
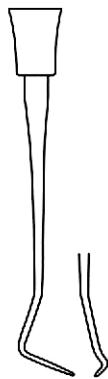



Fig. 23/17
 ZD-56-1572

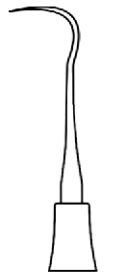

Fig. 2A
 ZD-56-1573



Fig. 3
 ZD-56-1574



Fig. 1N
 ZD-56-1575
 Nabers



Fig. 2N
 ZD-56-1576
 Nabers



Fig. 5/6
 ZD-56-1577

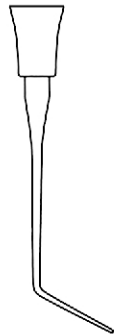
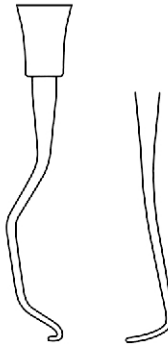

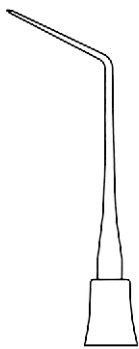

Fig. 16/23
ZD-56-1578



Fig. 6/23
ZD-56-1579



Fig. 6/17
ZD-56-1580



Fig. 23/17A
ZD-56-1581



Fig. 3/23
ZD-56-1582





ZD-56-1583
Fig. 1/2



ZD-56-1584
Fig. 3/4



ZD-56-1585
Fig. 5/6



ZD-56-1586
Fig. 7/8





ZD-56-1587
Fig. 9/10



ZD-56-1588
Fig. 11/12



ZD-56-1589
Fig. 13/14



ZD-56-1590
Fig. 15/16

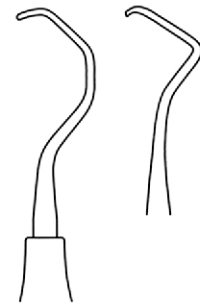

ZD-56-1591
Fig. 17/18

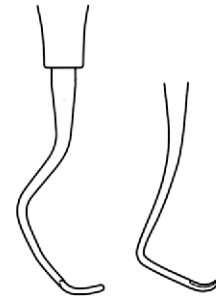



Langer
 ZD-56-1592
 Fig. 1/2

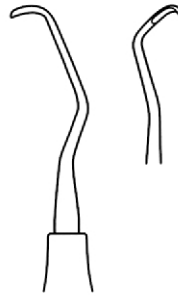

Langer
 ZD-56-1593
 Fig. 3/4



Langer
 ZD-56-1594
 Fig. 5/6



Langer
 ZD-56-1595
 Fig. 17/18



Universal curettes are designed for easy adaptation on all tooth surfaces (thus the name "universal").

The blade of a universal curette has a round toe and back, and two cutting edges for scaling, making it an efficient design for scaling the entire mouth.

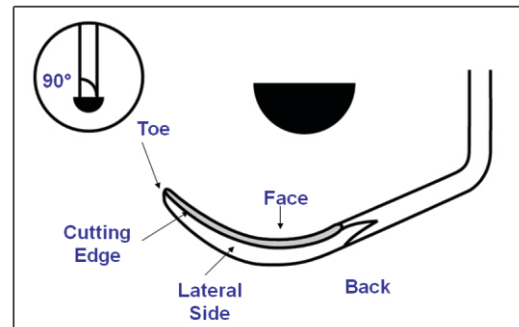



Columbia
 ZD-56-1596
 Fig. 13/14



Columbia
 ZD-56-1597
 Fig. 2R/2L



Columbia
 ZD-56-1598
 Fig. 4R/4L



ZD-56-1599
 Fig. Gx4



Barnhart
 ZD-56-1600
 Fig. 1/2



Barnhart
 ZD-56-1601
 Fig. 5/6



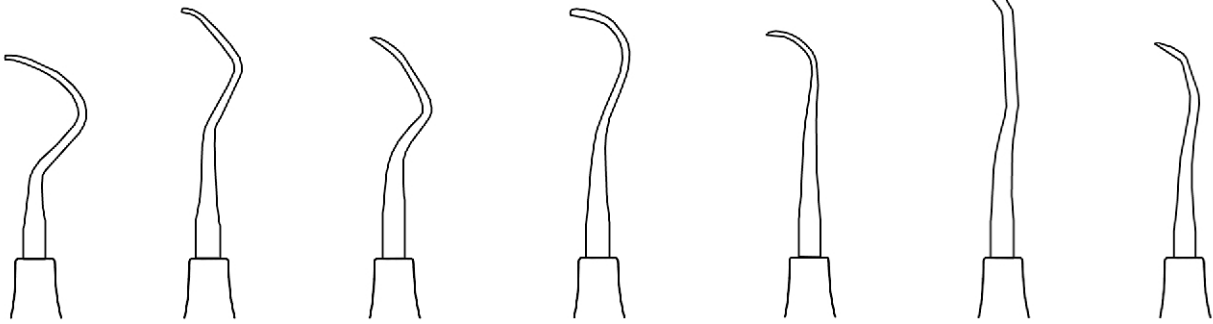

ZD-56-1602
Fig. Me1

ZD-56-1603
Rule [23-24]
Fig. 3/4

ZD-56-1604
Fig. IU 13/14
Indiana University

ZD-56-1605
Fig. IU 17/18
Indiana University

ZD-56-1606
Fig. 7/8
Younger-Good

ZD-56-1607
Fig. 1/2
Bunting

ZD-56-1608
Fig. 5/6
Bunting

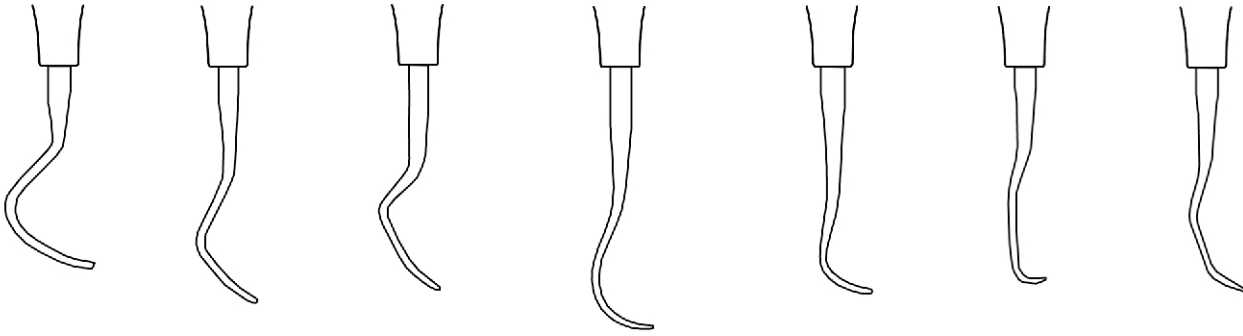



ZD-56-1609
 Fig. 1
 Furcation curette



ZD-56-1610
 Fig. 2
 Furcation curette



ZD-56-1611
 Fig. 3
 Furcation curette



ZD-56-1612
 Fig. 4
 Furcation curette



ZD-56-1613
 Fig. 5
 Furcation curette



ZD-56-1614
 Fig. 1/2
 Prichard



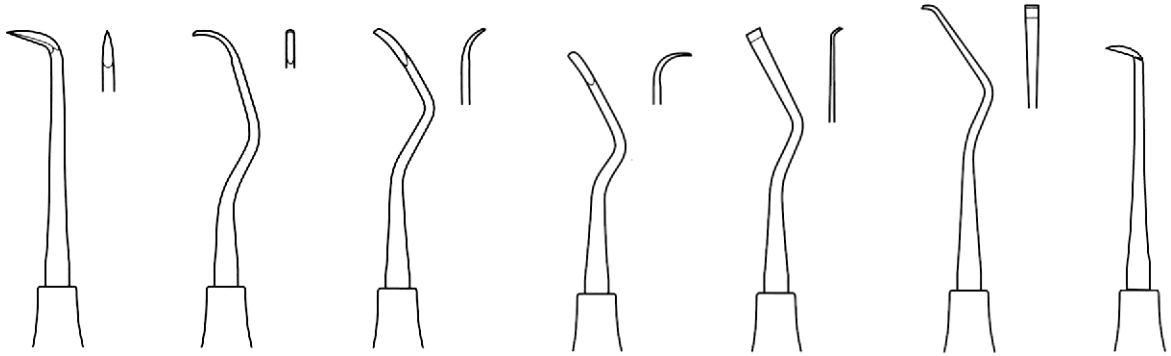

ZD-56-1615
Goldman-Fox
Fig. 1

ZD-56-1616
Goldman-Fox
Fig. 2

ZD-56-1617
Goldman-Fox
Fig. 3

ZD-56-1618
Goldman-Fox
Fig. 4

ZD-56-1619
Goldman-Fox
Fig. 5

ZD-56-1620
Goldman-Fox
Fig. 6

ZD-56-1621
Goldman-Fox
Fig. 21

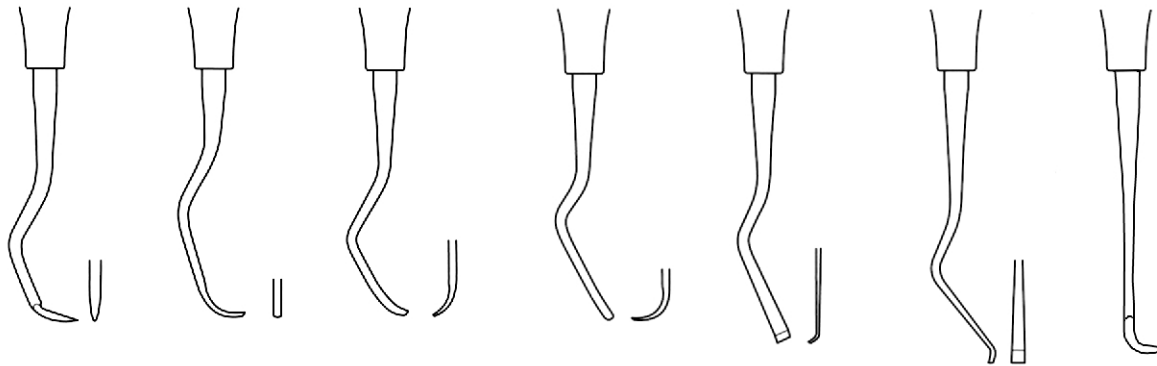

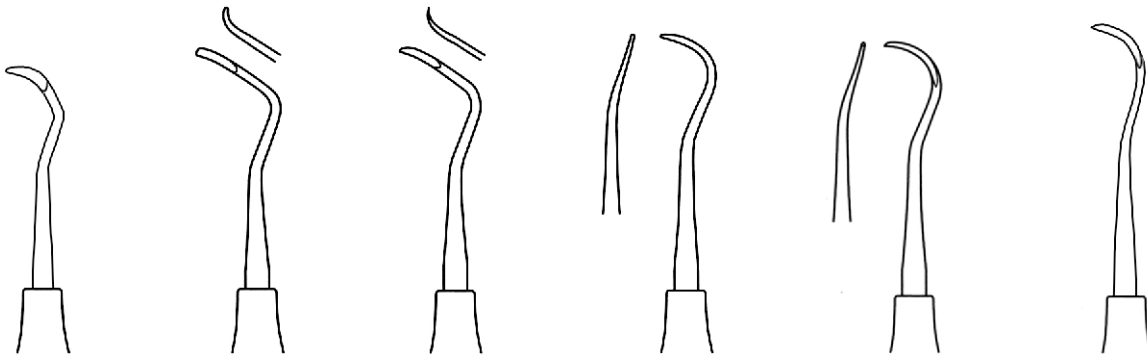

ZD-56-1622
 McCall
 Fig. 11/12

ZD-56-1623
 McCall
 Fig. 13S/14S

ZD-56-1624
 McCall
 Fig. 13SM/14

ZD-56-1625
 McCall
 Fig. 17/18

ZD-56-1626
 McCall
 Fig. 17S/18S

ZD-56-1627
 McCall
 Fig. 19/20

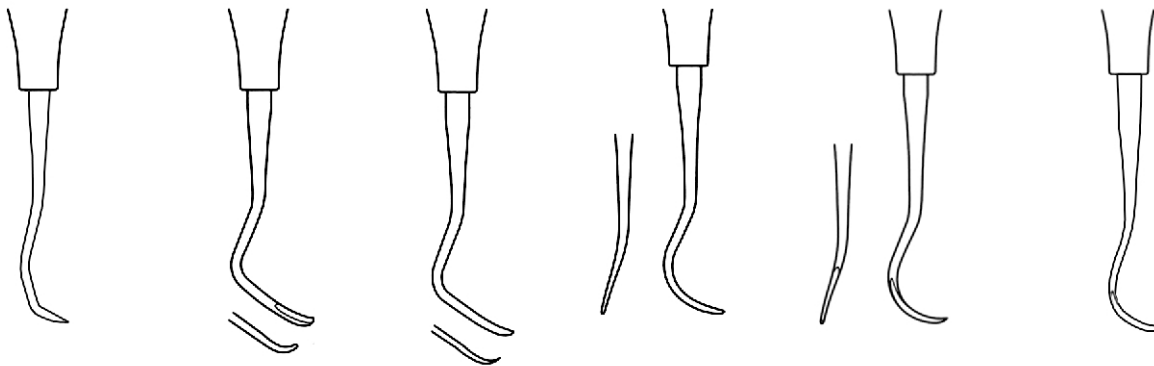

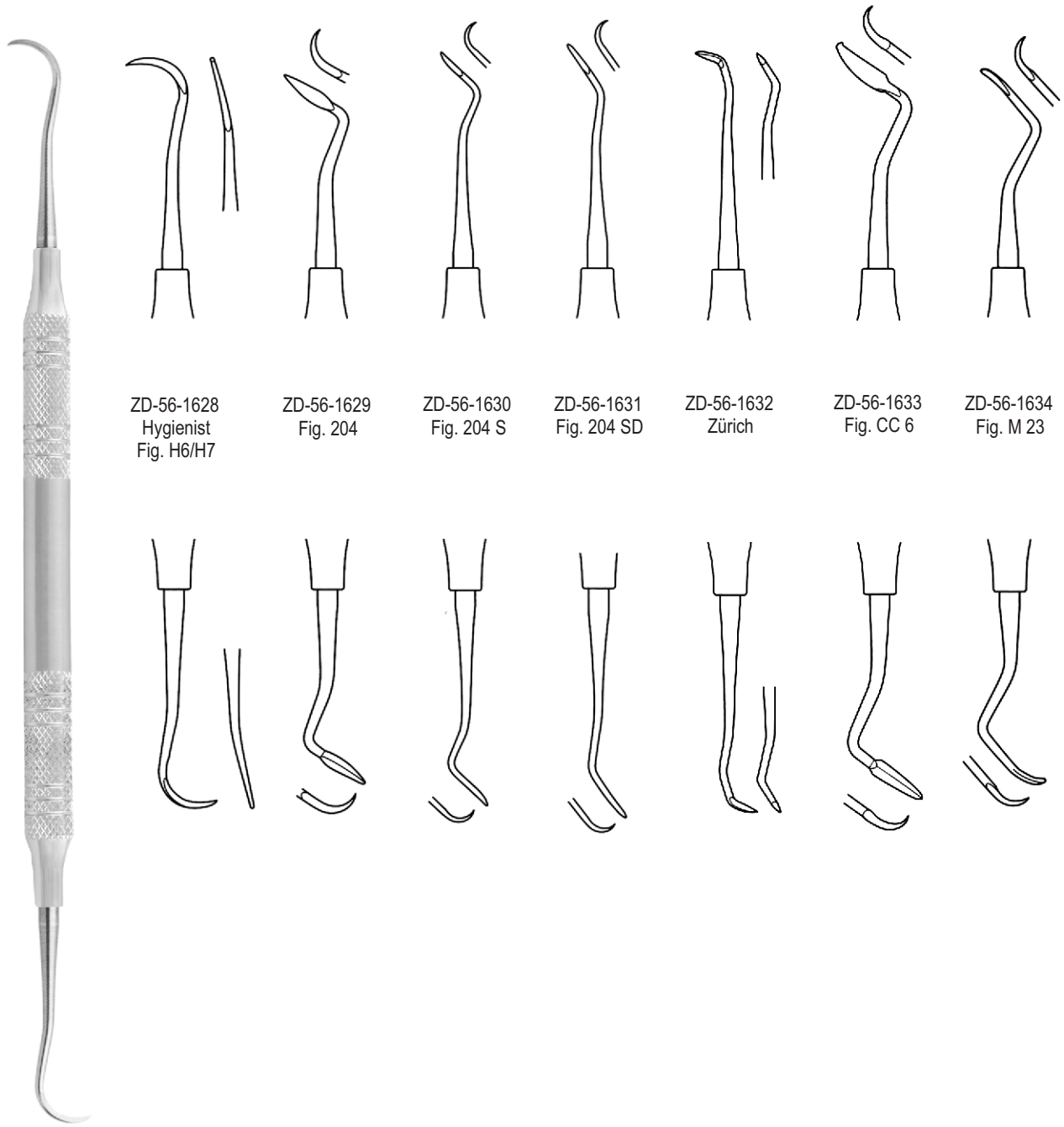

ZD-56-1628
 Hygienist
 Fig. H6/H7

ZD-56-1629
 Fig. 204

ZD-56-1630
 Fig. 204 S

ZD-56-1631
 Fig. 204 SD

ZD-56-1632
 Zürich

ZD-56-1633
 Fig. CC 6

ZD-56-1634
 Fig. M 23

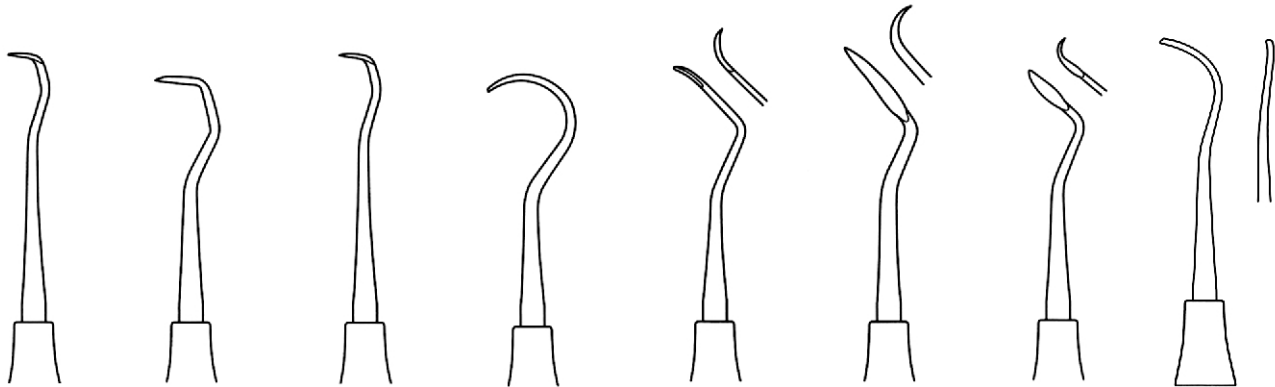

ZD-56-1635
 Hygienist-Towner
 Fig. H5/33

ZD-56-1636
 Towner
 Fig. U15/30

ZD-56-1637
 Towner
 Fig. U15/33

ZD-56-1638
 Hygienist-Towner
 Fig. H5/U15

ZD-56-1639
 Fig. U 135

ZD-56-1640
 Fig. CI 2/3

ZD-56-1641
 Taylor
 Fig. T2/T3

ZD-56-1642
 Younger-Good
 Fig. 33/34

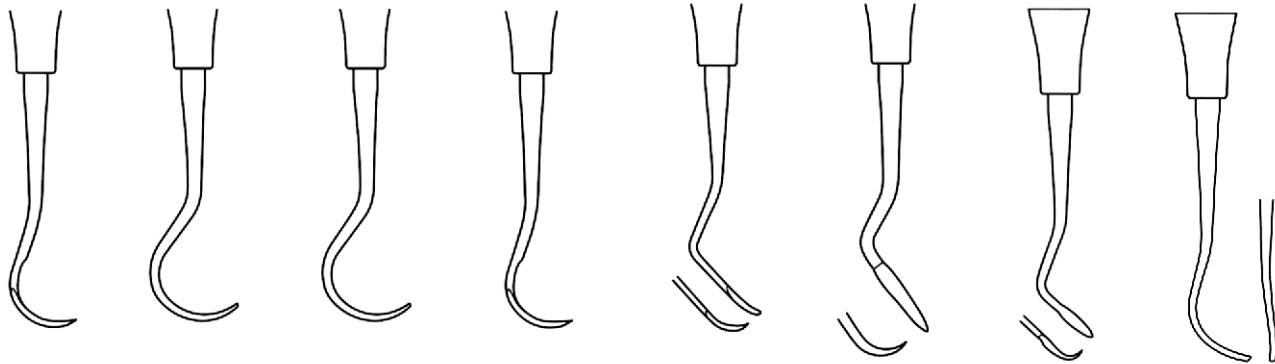

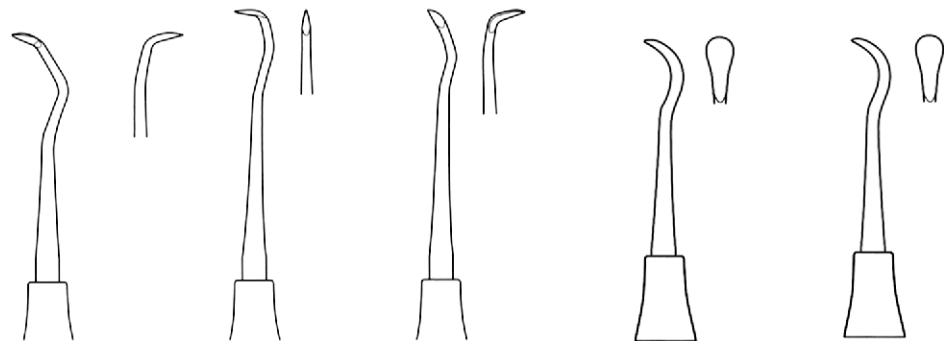

ZD-56-1643
 Jacquette
 Fig. 31/32

ZD-56-1644
 Jacquette
 Fig. 30/33

ZD-56-1645
 Jacquette
 Fig. 34/35

ZD-56-1646
 Cumine
 Fig. 33

ZD-56-1647
 Mitchell
 Fig. 34

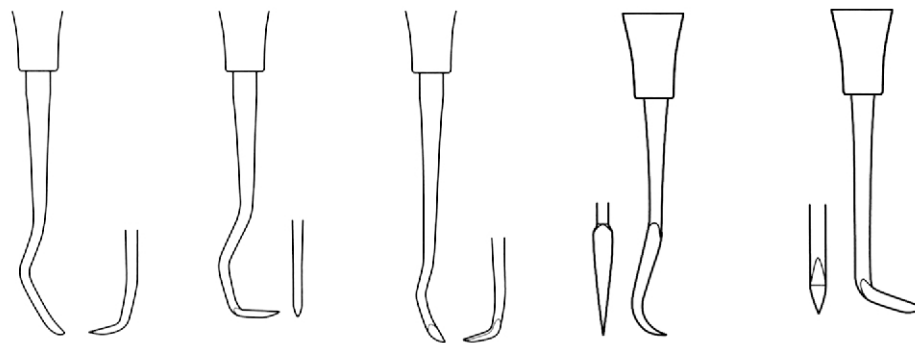



ZD-56-1648
 Jacquette
 Fig. 33

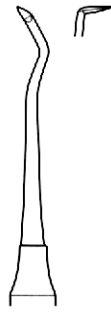

ZD-56-1649
 Jacquette
 Fig. 34

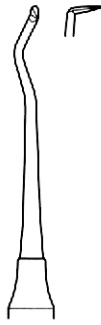

ZD-56-1650
 Jacquette
 Fig. 35



ZD-56-1651
 Ward-Kirkland
 Fig. 1



ZD-56-1652
 Crane-Kaplan
 Fig. 2



ZD-56-1653
 Mercitan
 Fig. Sh5



ZD-56-1654
 Crane-Kaplan
 Fig. 3



ZD-56-1655
 White
 Fig. 12B

57

- EN** Bone Curettes
- DE** Knochenküretten
- ES** Curetas de hueso

Page 79 to 84

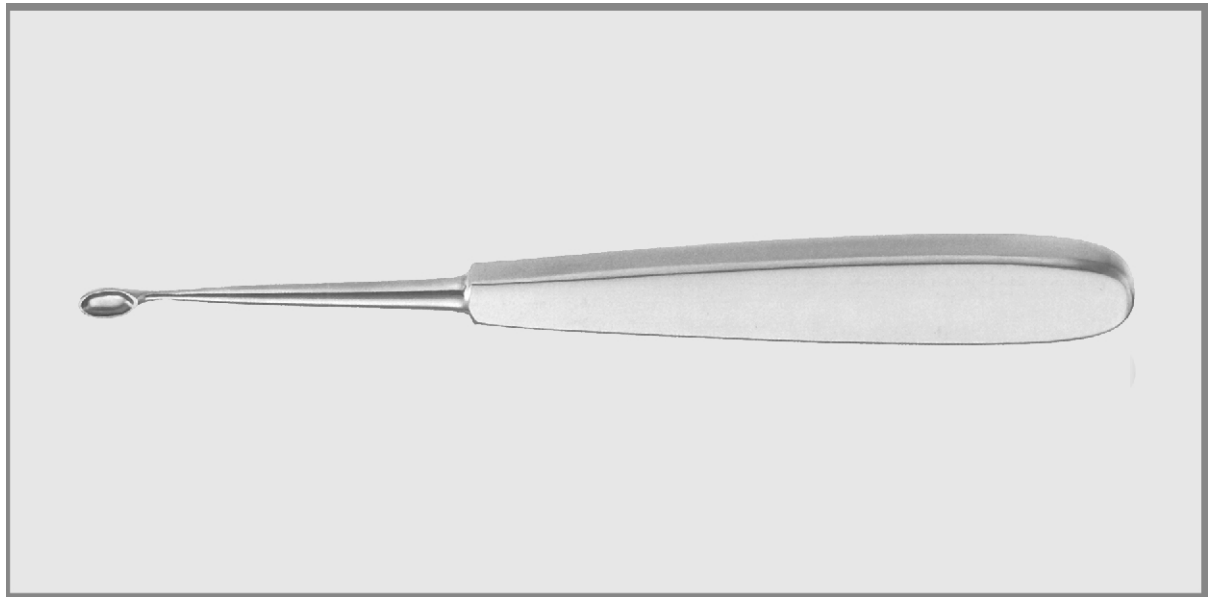

ZD-57-1701
 ZD-57-1702

ZD-57-1703
 ZD-57-1704



WILLIGER

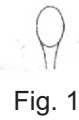
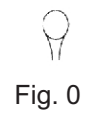

Fig. 00
 Fig. 0
 Fig. 1
 Fig. 2

ZD-57-1705 ZD-57-1709
 ZD-57-1706 ZD-57-1710
 ZD-57-1707 ZD-57-1711
 ZD-57-1708 ZD-57-1712

ZD-57-1713 ZD-57-1717
 ZD-57-1714 ZD-57-1718
 ZD-57-1715 ZD-57-1719
 ZD-57-1716 ZD-57-1720



Mod. USA



Fig. 1	ZD-57-1721	R	ZD-57-1727	L	ZD-57-1733
Fig. 2	ZD-57-1722		ZD-57-1728		ZD-57-1734
Fig. 3	ZD-57-1723		ZD-57-1729		ZD-57-1735
Fig. 4	ZD-57-1724		ZD-57-1730		ZD-57-1736
Fig. 5	ZD-57-1725		ZD-57-1731		ZD-57-1737
Fig. 6	ZD-57-1726		ZD-57-1732		ZD-57-1738

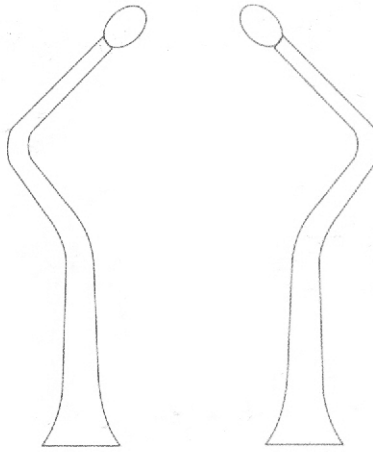

R

L



ZD-57-1740
R

ZD-57-1741
L

CHOMPRET
ZD-57-1739

ZD-57-1748- ZD-57-1750R-
 ZD-57-1749 ZD-57-1751R



ZD-57-1742
 Fig. 00/00

ZD-57-1743
 Fig. 0/0

ZD-57-1744
 Fig. 1/1



ZD-57-1745
 Fig. 00/00

ZD-57-1746
 Fig. 0/0

ZD-57-1747
 Fig. 1/1

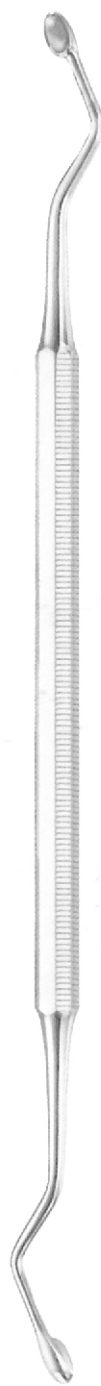

ZD-57-1752
 ZD-57-1753
 Fig. 1R / 1L

ZD-57-1754
 ZD-57-1755
 Fig. 2R / 2L

ZD-57-1756
 ZD-57-1757
 Fig. 3R / 3L

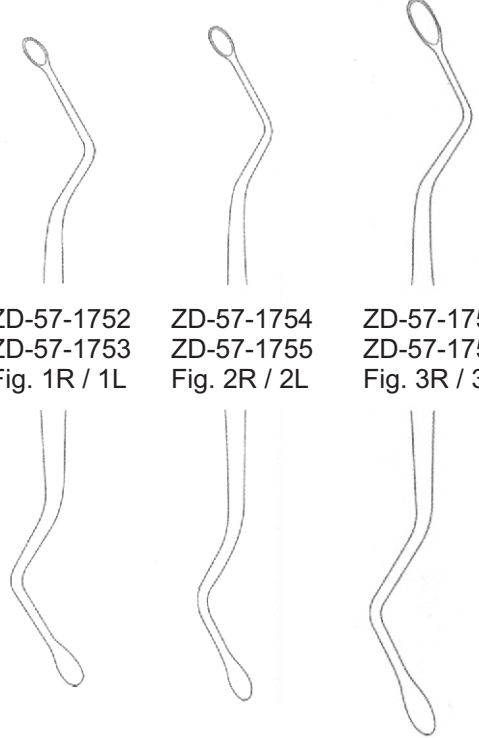

WILLGER

MARTINI

HEMINGWAY
 18 CM/7"

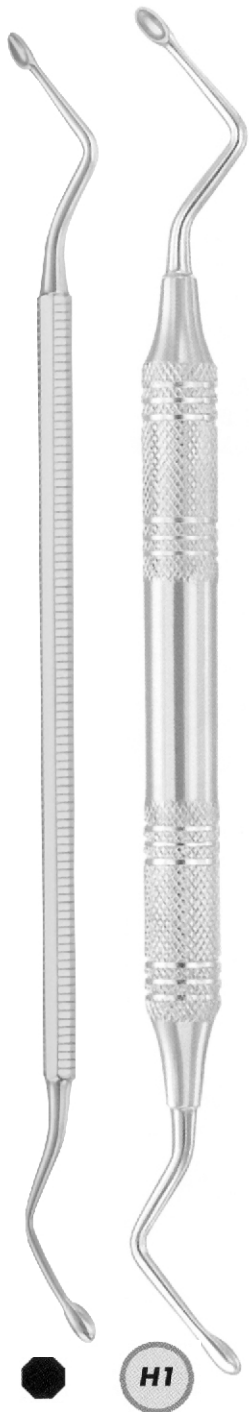

5,5 mm Ø9,5 mm
 HEMINGWAY
 17 cm/6 ¾"

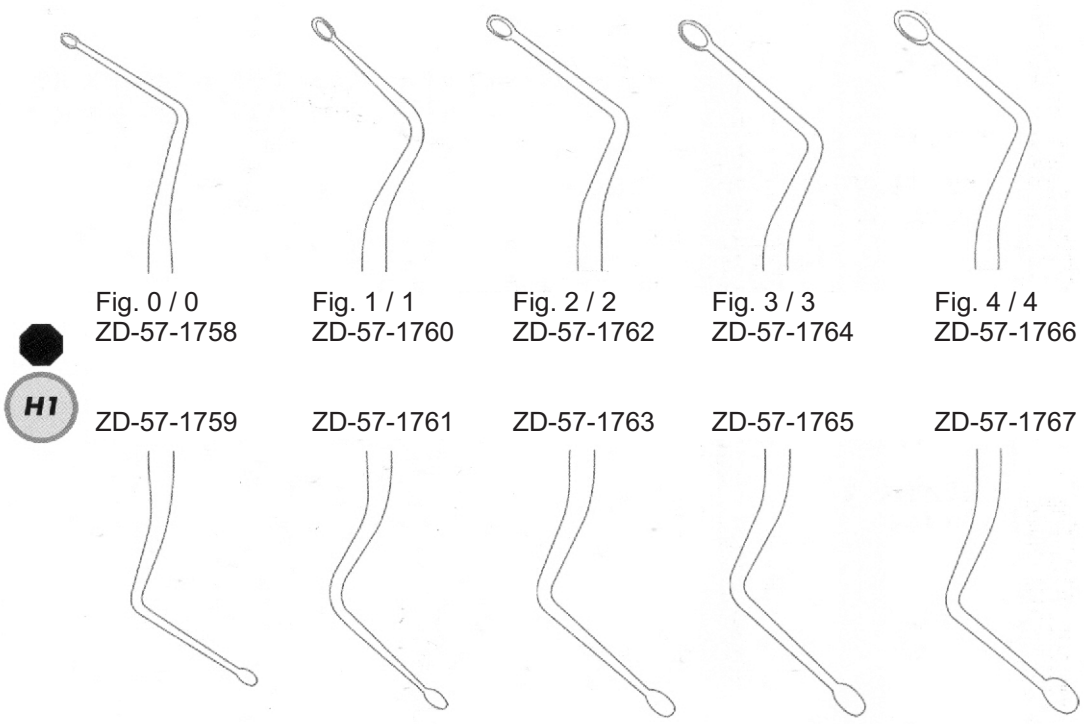

ZD-57-1768 ZD-57-1770
 ZD-57-1769 ZD-57-1771

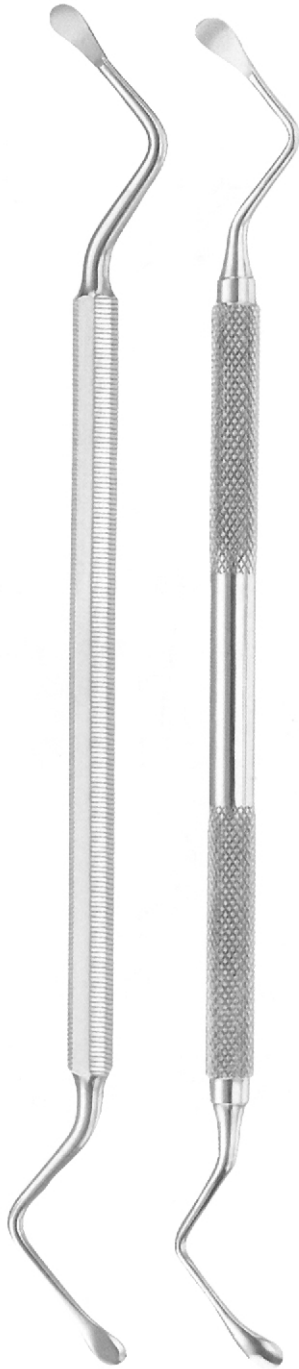

LUCAS
 17 cm/6¾"

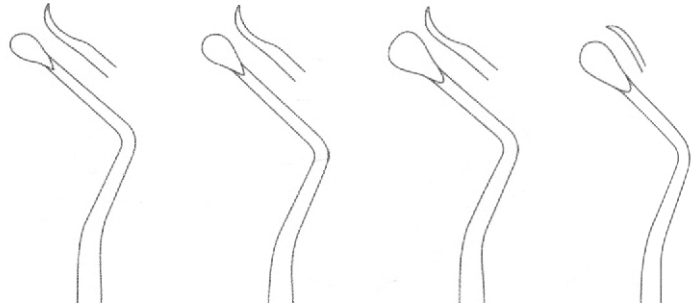

ZD-57-1772
 ZD-57-1773
 Fig. 1 / 1

ZD-57-1774
 ZD-57-1775
 Fig. 2 / 2

ZD-57-1776
 ZD-57-1777
 Fig. 3 / 3

ZD-57-1778
 ZD-57-1779
 Fig. 4 / 4



Bone Currettes ● EN
 Scharf Löffel ● DE
 Curettes á os ● ES

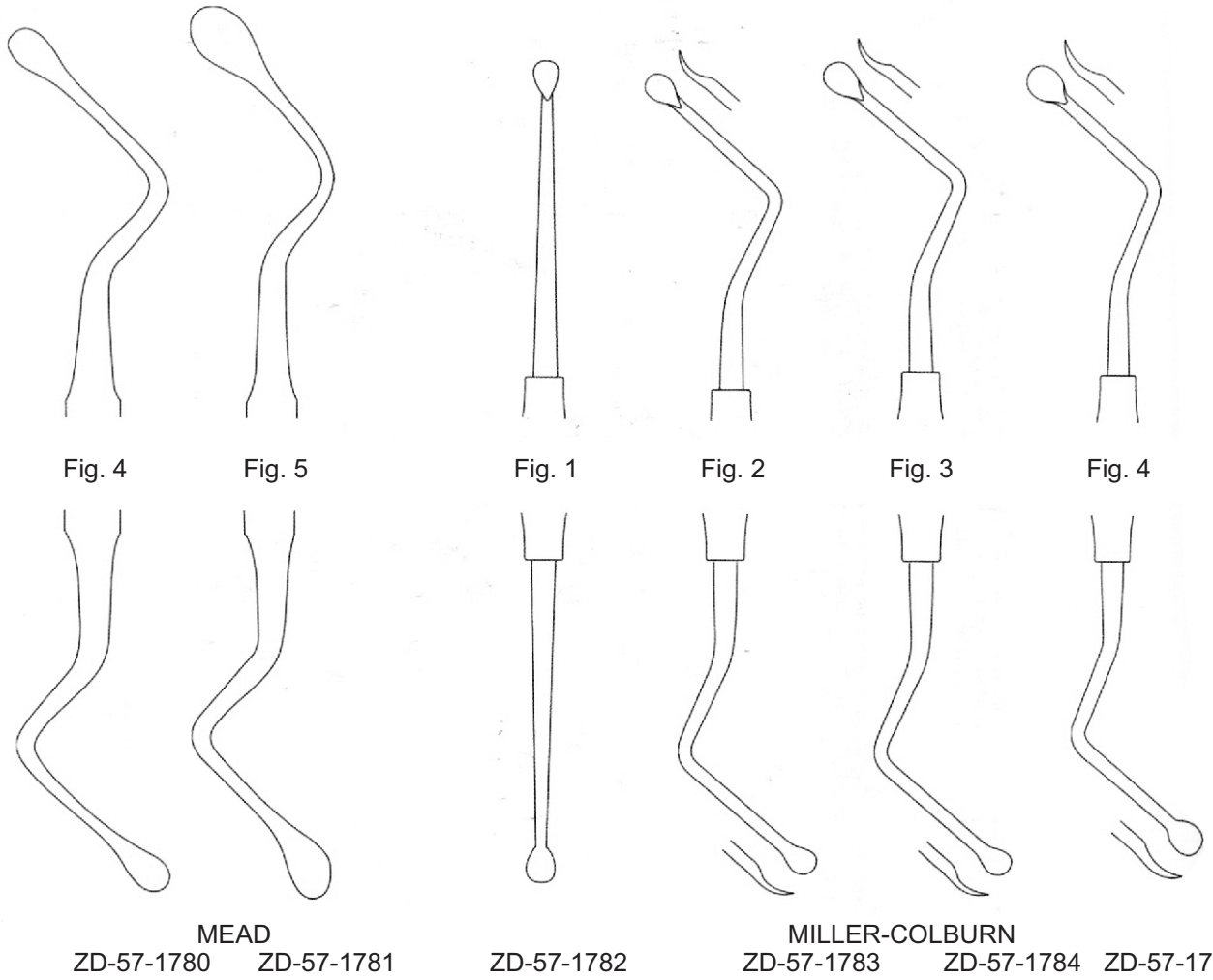

58

- EN** Excavators
- DE** Bagger
- ES** Excavadoras

Page 85 to 89



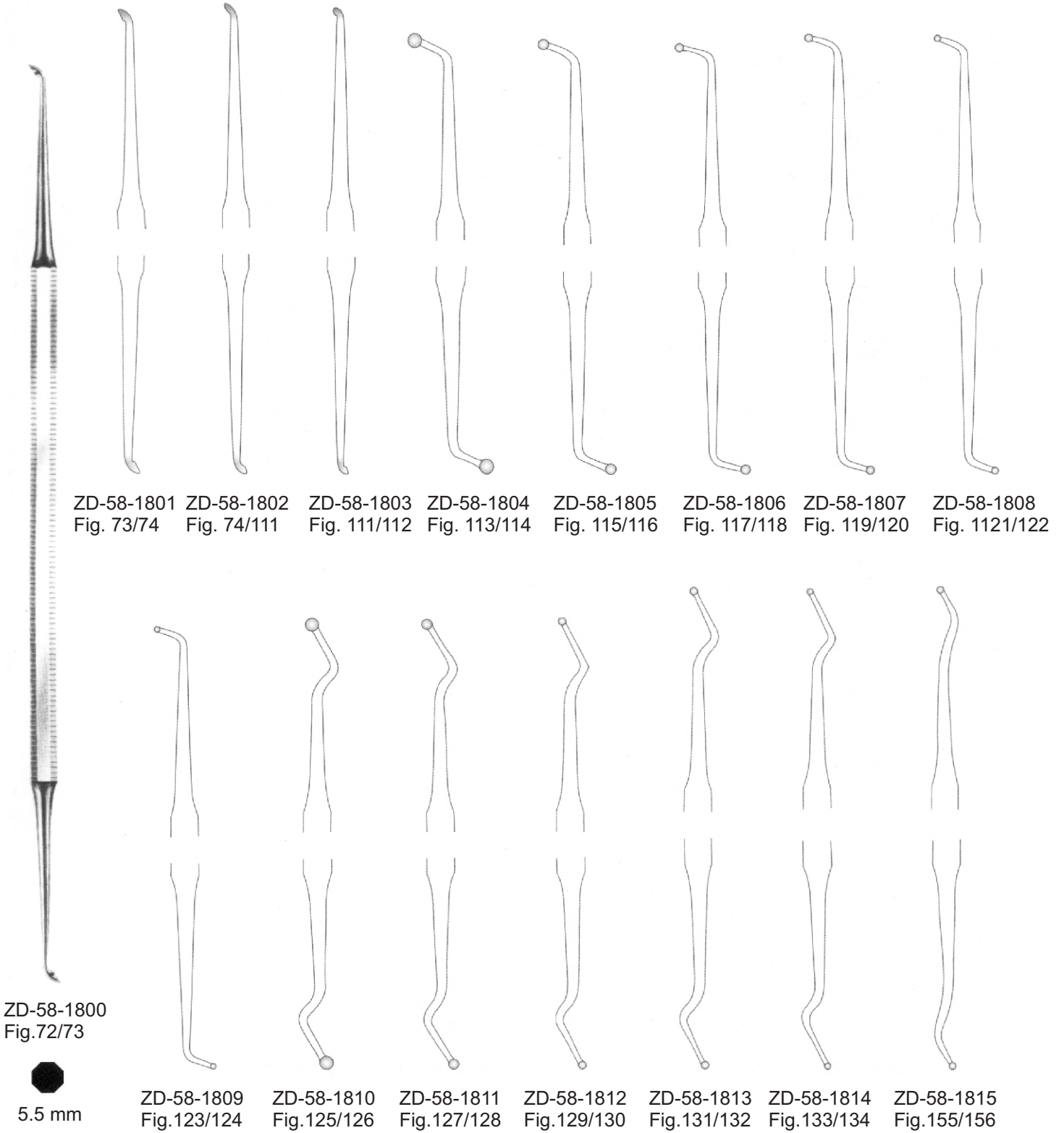

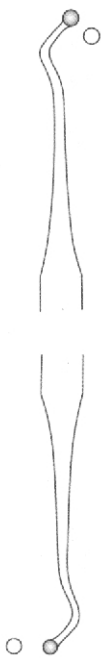

ZD-58-1816
 Fig.139/140

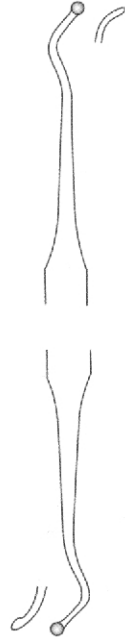

ZD-58-1817
 Fig.141/142



ZD-58-1818
 Fig.159/160



ZD-58-1819
 Fig.161/162

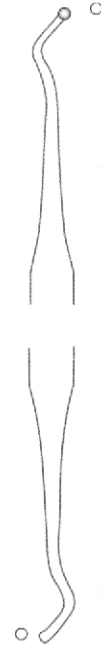

ZD-58-1820
 Fig.165/166



ZD-58-1821
 Fig.171/172



ZD-58-1822
 Fig.173/174



ZD-58-1823
 Fig.175/176



ZD-58-1824
 Fig.177/178



ZD-58-1825
 Fig.179/180

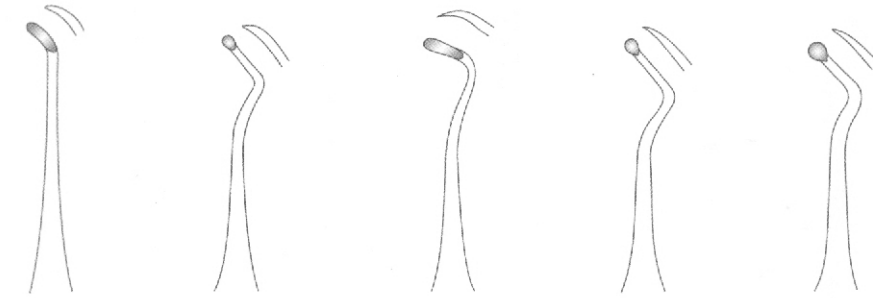

ZD-58-1826
Fig. 5

ZD-58-1827
Fig. 13

WHITE
ZD-58-1828
Fig. 14

ZD-58-1829
Fig. 15

ZD-58-1830
Fig. 17

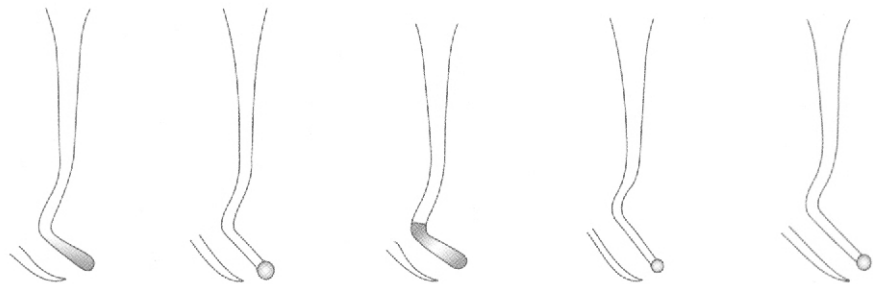

ZD-58-1831
Fig. 18

ZD-58-1832
Fig. 19

WHITE
ZD-58-1833
Fig. 20

ZD-58-1834
Fig. 23

ZD-58-1835
Fig. 25

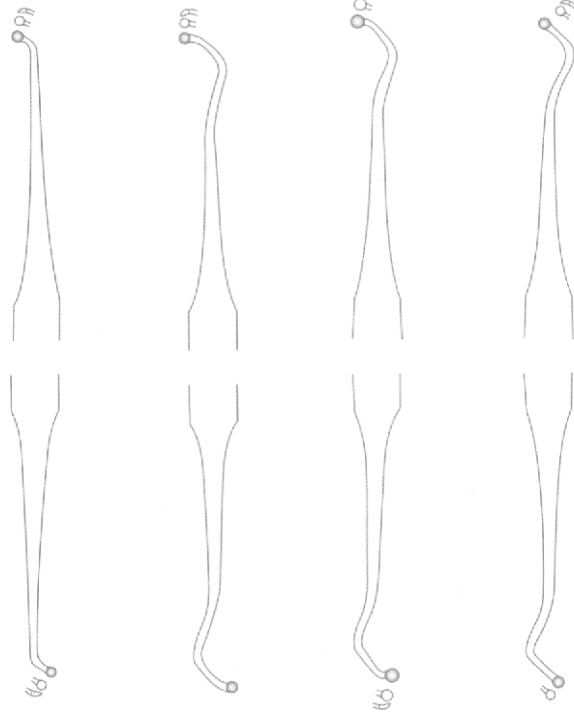

●	Fig. 5 ZD-58-1836	Fig. 13 ZD-58-1837	Fig. 14 ZD-58-1838	Fig. 17 ZD-58-1839
H1 ●	ZD-58-1840	ZD-58-1841	ZD-58-1842	ZD-58-1843

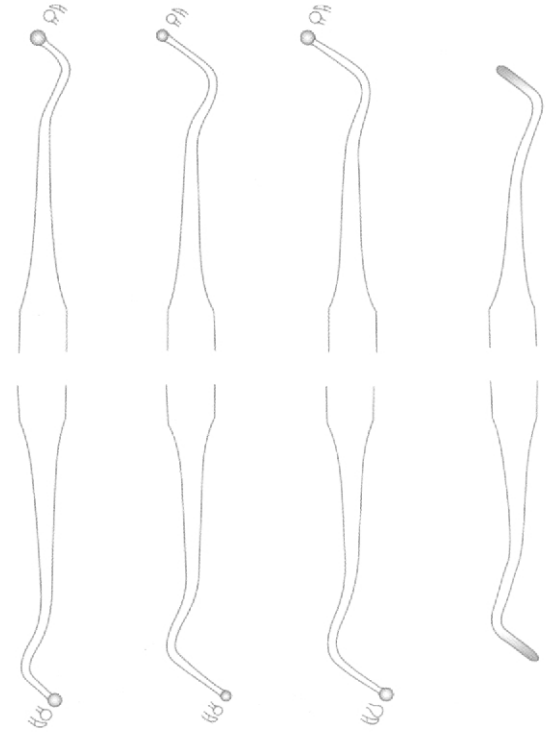

●	Fig.18 ZD-58-1844	Fig. 31 ZD-58-1845	Fig. 33 ZD-58-1846	Fig. 35 ZD-58-1847
H1 ●	ZD-58-1848	ZD-58-1849	ZD-58-1850	ZD-58-1851

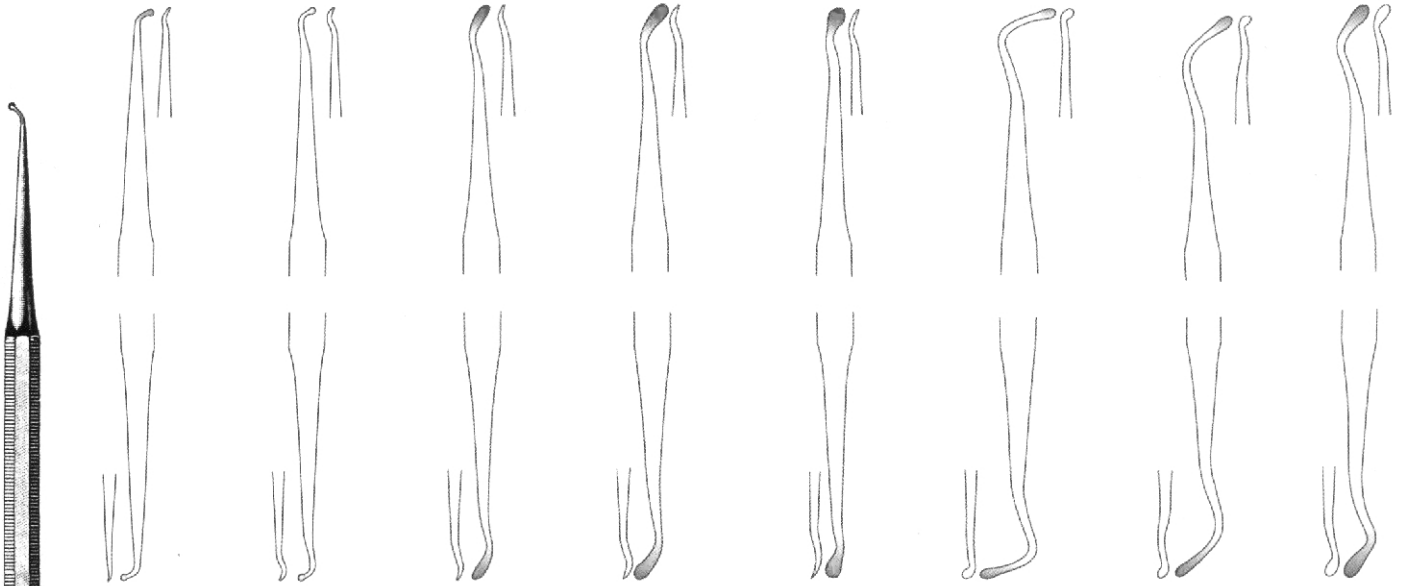

DARBY-PERRY

ZD-58-1853 Fig. 7/8	ZD-58-1854 Fig. 9/10	ZD-58-1855 Fig. 11/12	ZD-58-1856 Fig. 13/14	ZD-58-1857 Fig. 15/16	ZD-58-1858 Fig. 17/18	ZD-58-1859 Fig. 19/20	ZD-58-1860 Fig. 21/22
------------------------	-------------------------	--------------------------	--------------------------	--------------------------	--------------------------	--------------------------	--------------------------



ZD-58-1852
Fig. 5/6

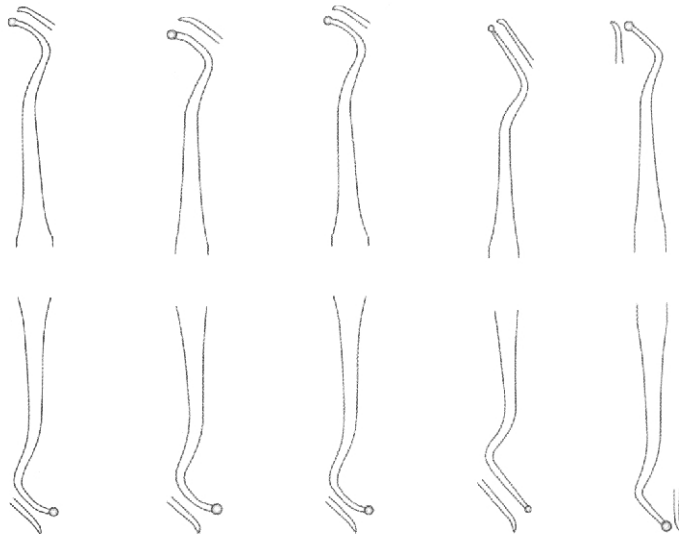

GILLET

ZD-58-1861 Fig. 4/5	ZD-58-1862 Fig. 6/7	ZD-58-1863 Fig. 7/8	ZD-58-1864 Fig. 12/13	ZD-58-1865 Fig. 14/15
------------------------	------------------------	------------------------	--------------------------	--------------------------

59

- EN** Wax Proclein
- DE** Wachs-Porzellan
- ES** cera Porcelana

Page 90 to 94

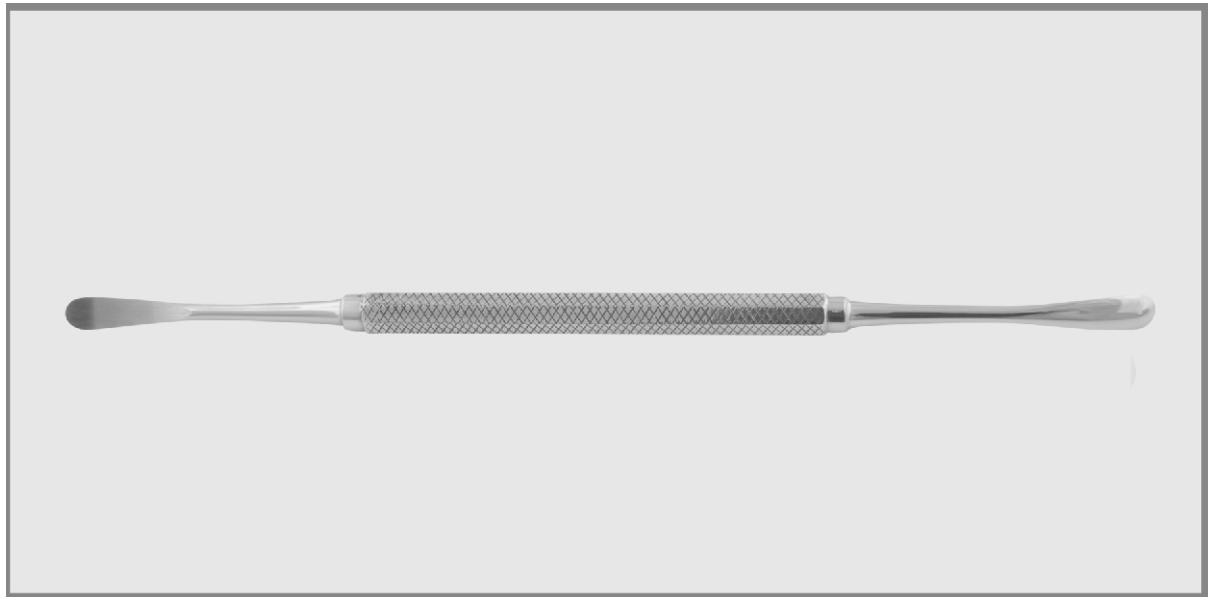

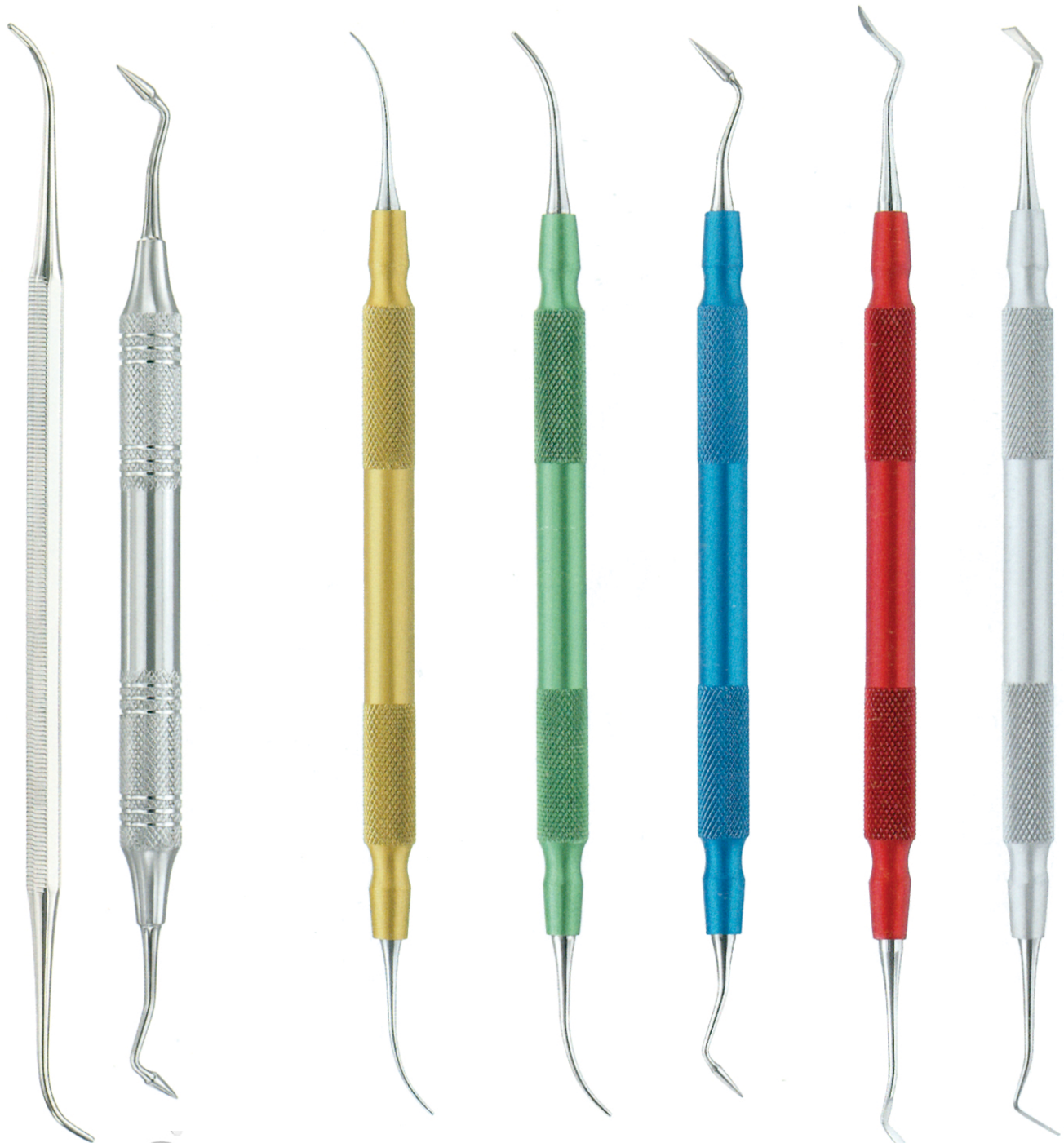

● 5,5 mm

● H1
 Ø9,5 mm



ZD-59-1901
 Fig. 1

ZD-59-1902
 Fig. 2

ZD-59-1903
 Fig. 3

ZD-59-1904
 Fig. 4

ZD-59-1905
 Fig. 5



ZD-59-1906H

ZD-59-1907H

ZD-59-1908H

ZD-59-1909H

ZD-59-1910H

Aluminium

ZD-59-1911

ZD-59-1912

ZD-59-1913

ZD-59-1914

ZD-59-1915

gold

green

blue

red

silver

MODELLING

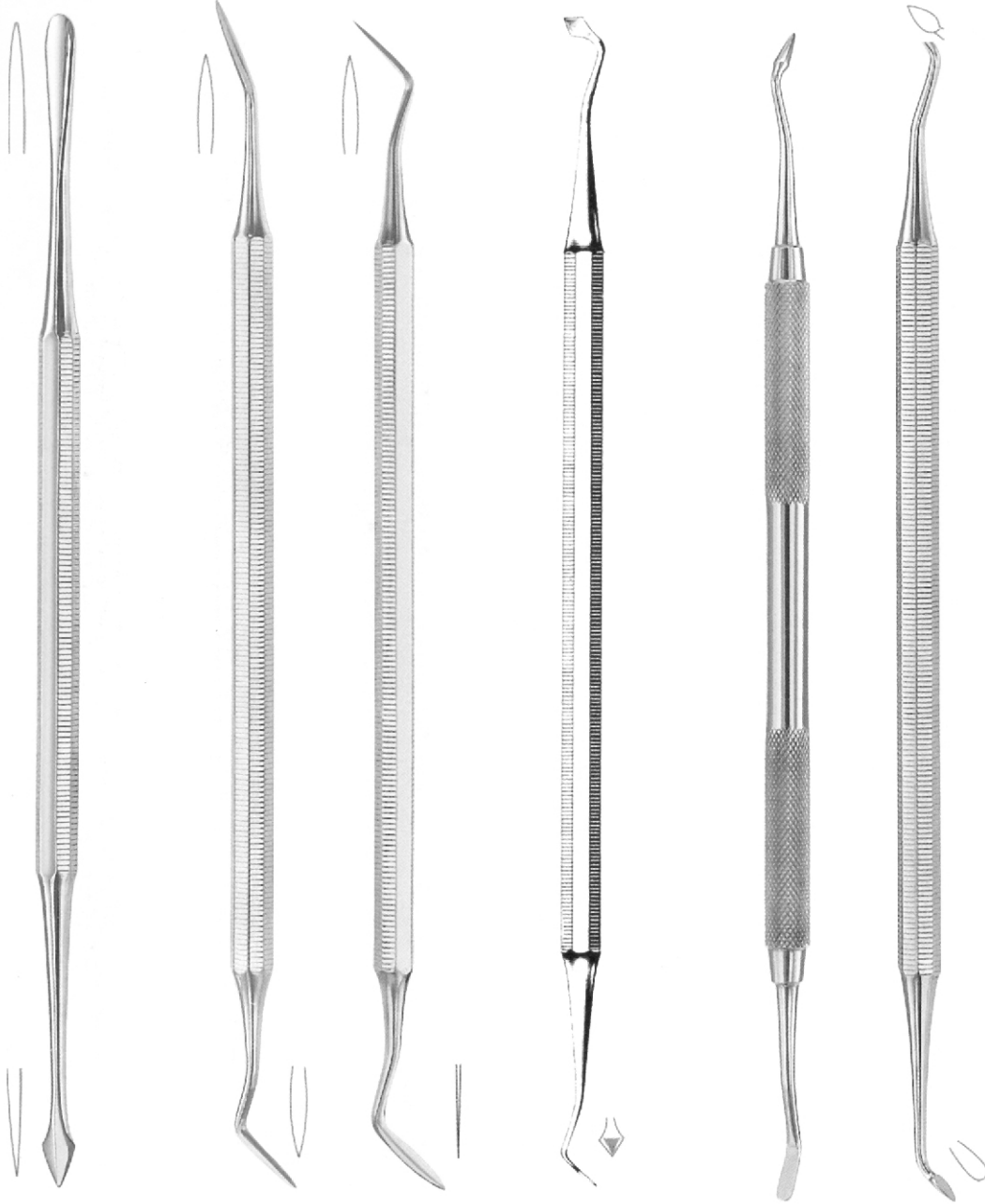

GRITMAN
 ZD-59-1916

WARD
 ZD-59-1917 Fig. 1
 ZD-59-1918 Fig. 2

FRAHM
 ZD-59-1919

SHOSHAN
 ZD-59-1920
 SHO-A

W.A.C.D
 ZD-59-1921

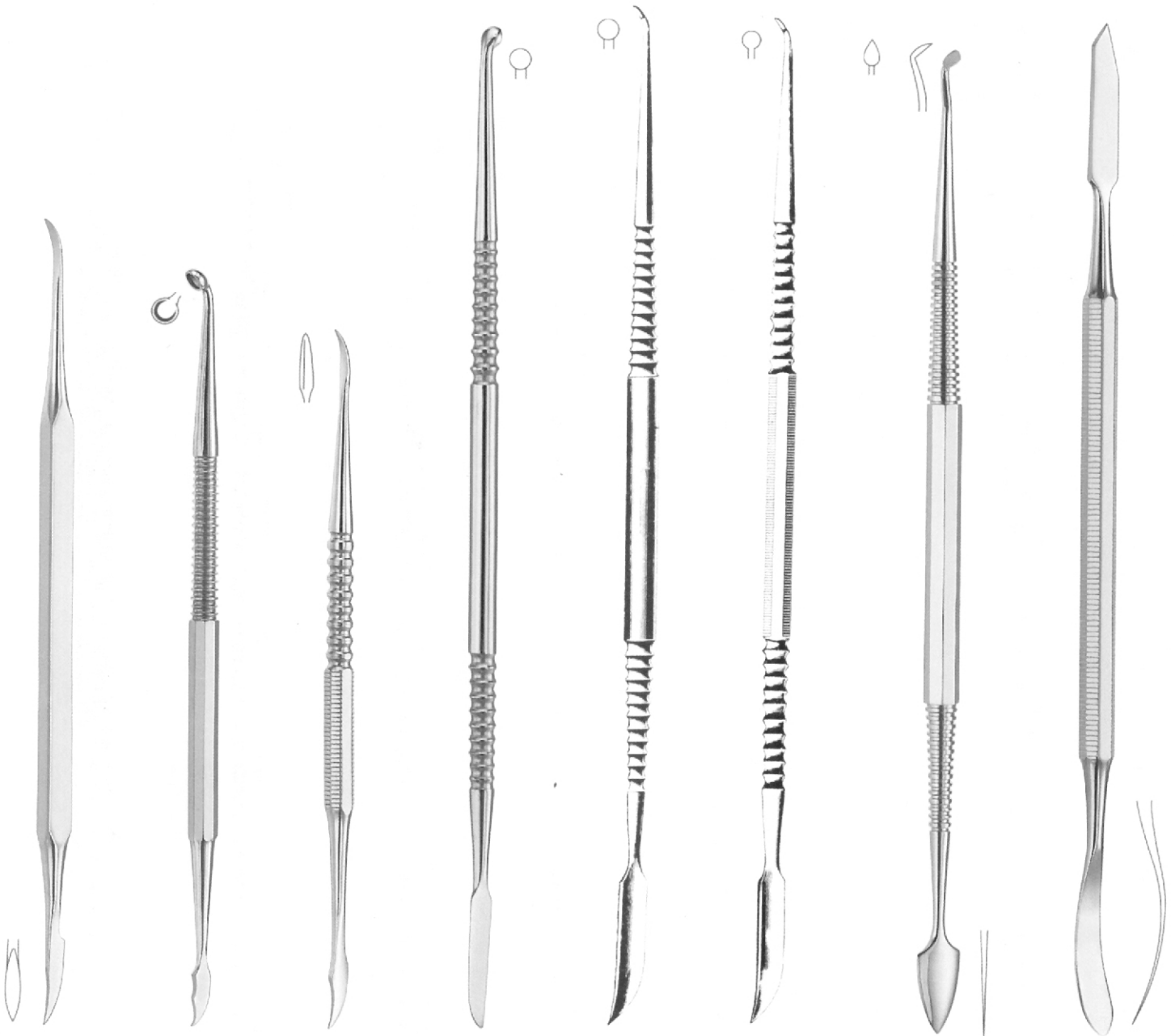

HYLIN
ZD-59-1922

ZAHLE
ZD-59-1923

ZAHLE
ZD-59-1924

LE CRON
ZD-59-1925

LE CRON
ZD-59-1926

LE CRON
ZD-59-1927

VEHE
ZD-59-1928

FIELDSTAD
ZD-59-1929

MODELLING



ROACH
 ZD-59-1930 ZD-59-1931

RIEGNER
 ZD-59-1932

ZD-59-1933
 Fig. 1

ZD-59-1934
 Fig. 2

FRAHM
 ZD-59-1935
 Fig. 6

ZD-59-1936
 Fig. 10

ZD-59-1937
 Fig. 6/10

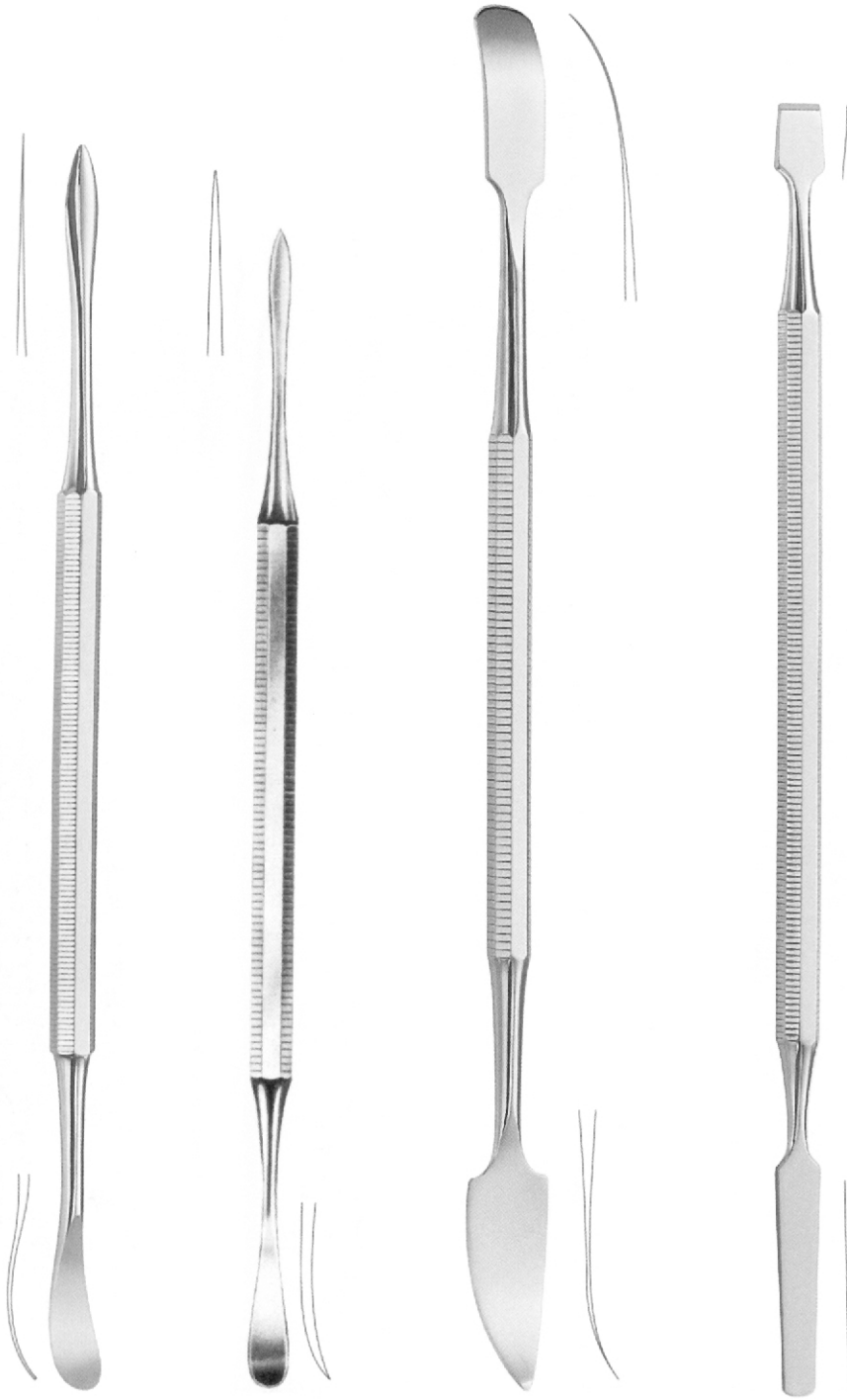

BEALE
 ZD-59-1938 ZD-59-1939
 Fig. 7A

GRITMAN
 ZD-59-1940
 19,5 cm/7 ¾"

WESTON
 ZD-59-1941

60

- EN** Filling Instruments
- DE** Füllungsinstrumente
- ES** Actos de llenado

Page 95 to 105

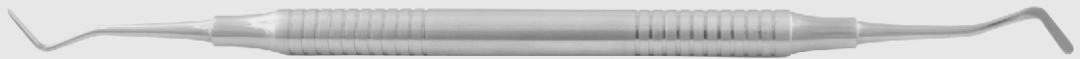

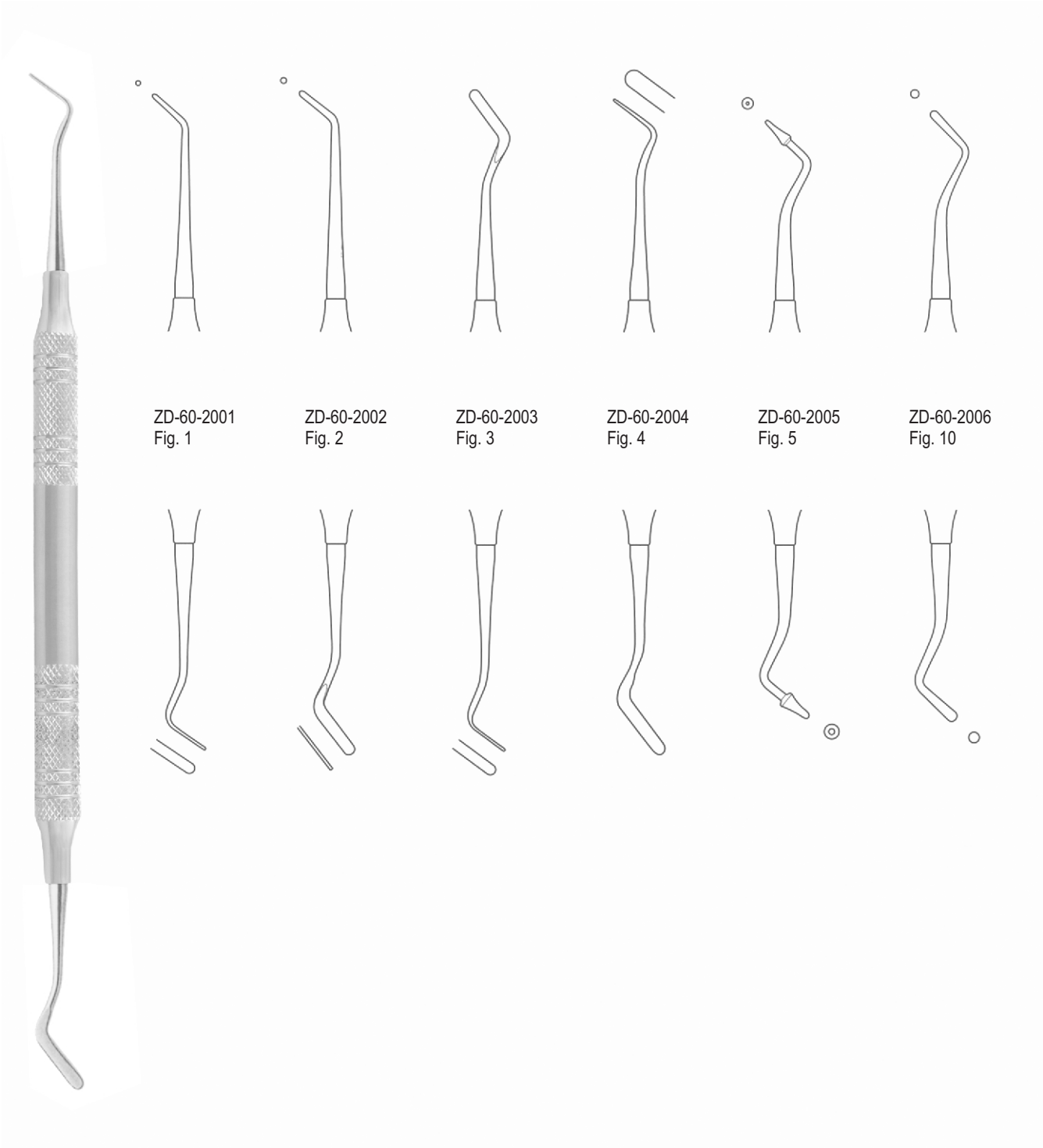

ZD-60-2001
Fig. 1

ZD-60-2002
Fig. 2

ZD-60-2003
Fig. 3

ZD-60-2004
Fig. 4

ZD-60-2005
Fig. 5

ZD-60-2006
Fig. 10

Note: Titanium Coated Points are available on customer demand.

FELLING INSTRUMENTS

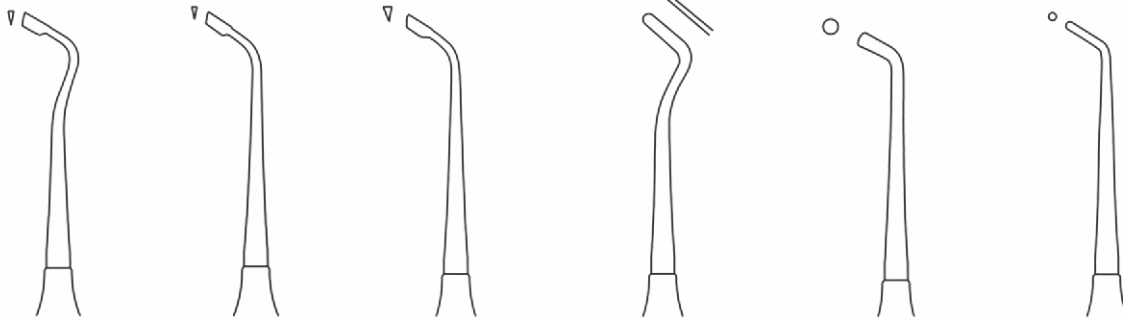

ZD-60-2007
 Fig. 1
 Felt

ZD-60-2008
 Fig. 2
 Felt

ZD-60-2009
 Fig. 3
 Felt

ZD-60-2010
 Fig. 4
 Felt

ZD-60-2011
 Fig. 5
 Felt

ZD-60-2012
 Fig. 6
 Felt

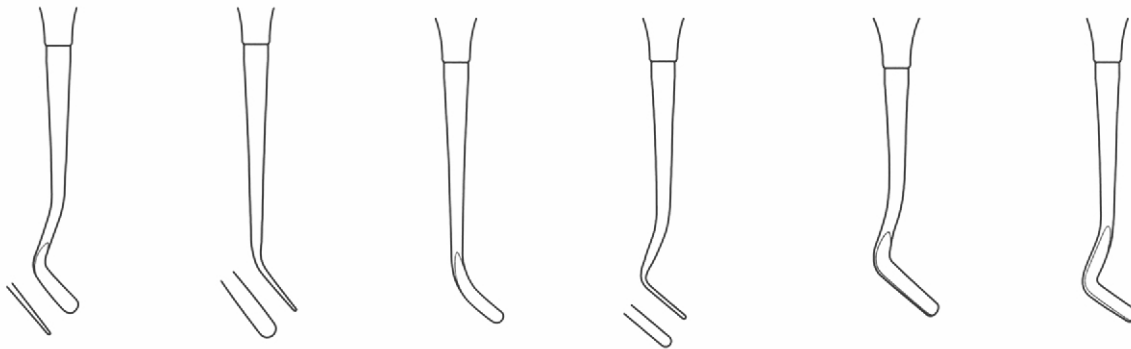



ZD-60-2013
 Fig. 1
 Goldstein



ZD-60-2014
 Fig. 2
 Goldstein



ZD-60-2015
 Fig. 3
 Goldstein



ZD-60-2016
 Fig. 4
 Goldstein



ZD-60-2017
 Fig. 9/10



ZD-60-2018
 Fig. 11/12



FELLING INSTRUMENTS

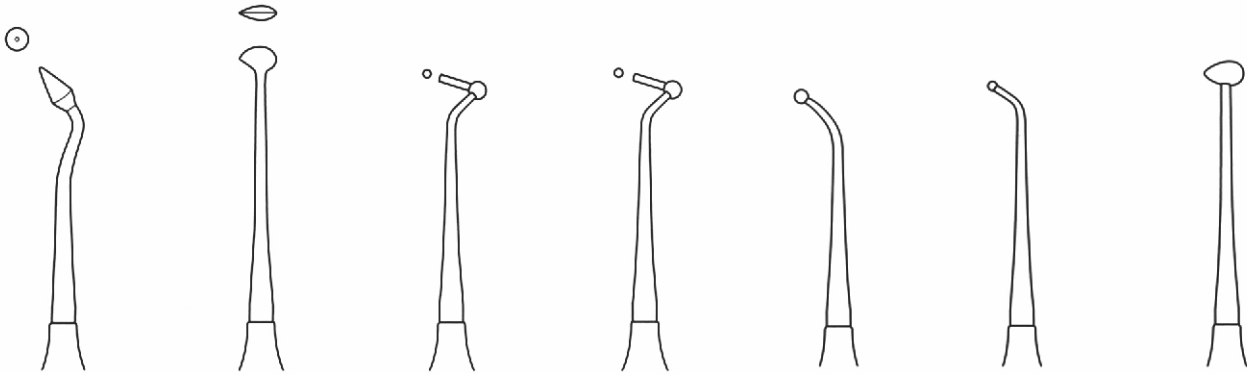

ZD-60-2019
Fig. SB

ZD-60-2020
Fig. 29/2B

ZD-60-2021
Fig. L1
Loesche

ZD-60-2022
Fig. L2
Loesche

ZD-60-2023
Fig. 18
Ball Burnisher

ZD-60-2024
Fig. 26/27S
Ball Burnisher

ZD-60-2025
Fig. 28/29
Ball Burnisher

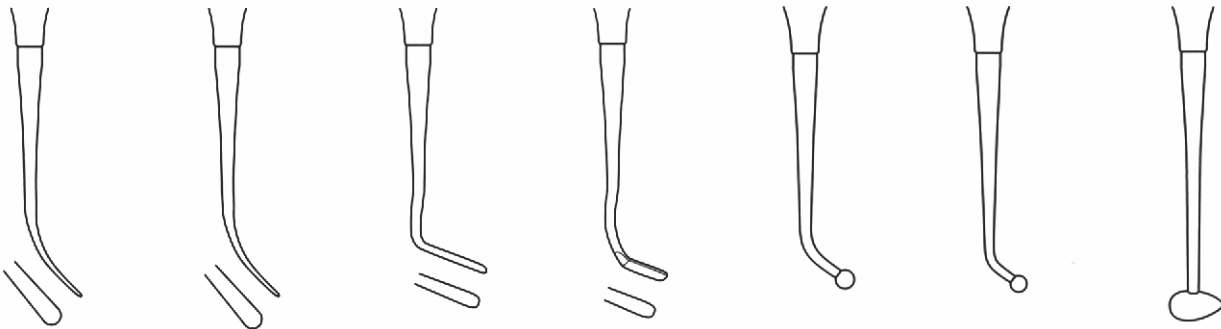

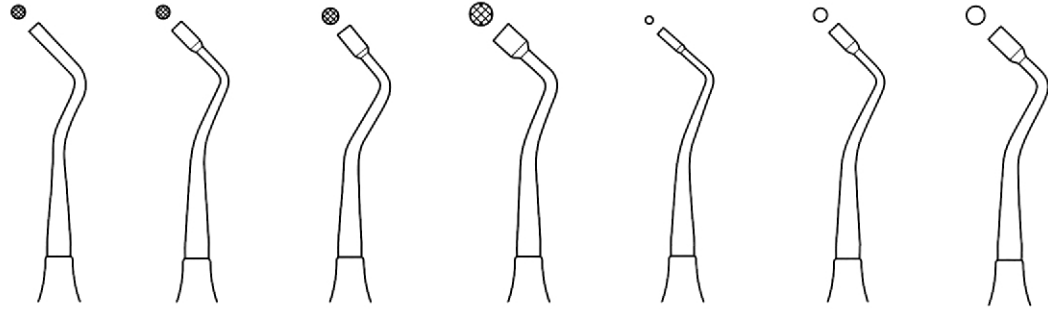

ZD-60-2026
Fig. 1S

ZD-60-2027
Fig. 2S

ZD-60-2028
Fig. 3S

ZD-60-2029
Fig. 4S

ZD-60-2030
Fig. 1P

ZD-60-2031
Fig. 2P

ZD-60-2032
Fig. 3P

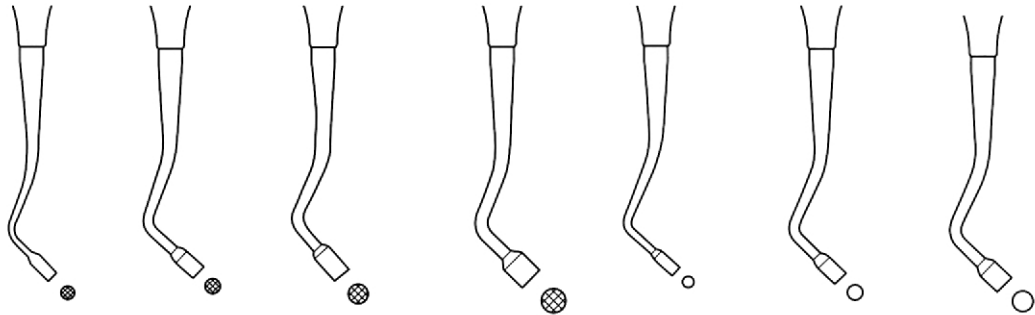

FELLING INSTRUMENTS



ZD-60-2033
Fig. 4P



ZD-60-2034
Fig. 1D



ZD-60-2035
Fig. 2D



ZD-60-2036
Fig. 3D



ZD-60-2037
Fig. M1
Markley



ZD-60-2038
Fig. M2



ZD-60-2039
Fig. M3



ZD-60-2040
Fig. M4



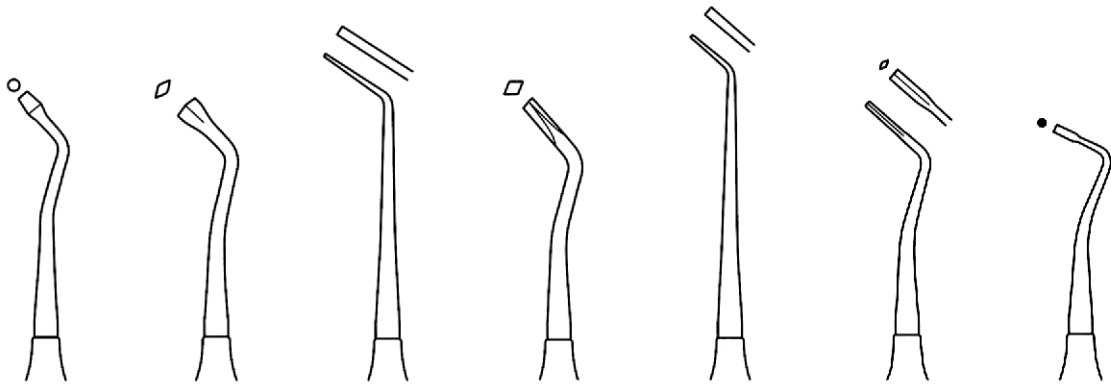

ZD-60-2041
Fig. M5

ZD-60-2042
Fig. M6

ZD-60-2043
Fig. H1
Hollenback

ZD-60-2044
Fig. H2
Hollenback

ZD-60-2045
Fig. H3
Hollenback

ZD-60-2046
Fig. H4
Hollenback

ZD-60-2047
Fig. MQ 1S

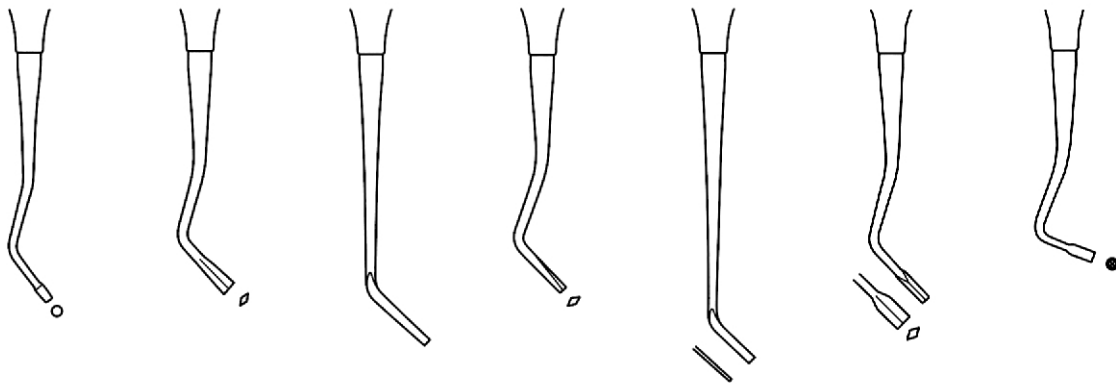

FELLING INSTRUMENTS

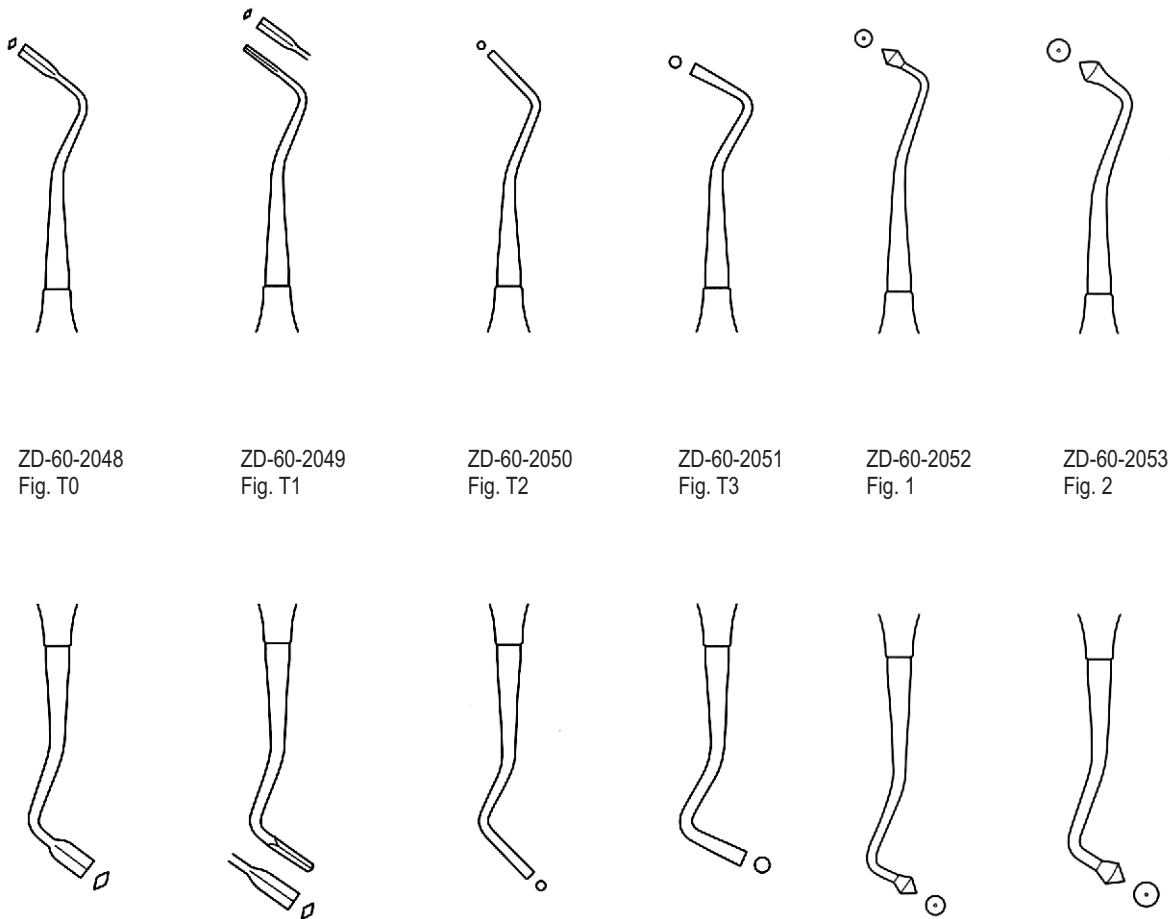

ZD-60-2048
Fig. T0

ZD-60-2049
Fig. T1

ZD-60-2050
Fig. T2

ZD-60-2051
Fig. T3

ZD-60-2052
Fig. 1

ZD-60-2053
Fig. 2



ZD-60-2054
Fig. 3

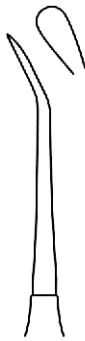

ZD-60-2055
Fig. WO 1
Woodson



ZD-60-2056
Fig. WO 2
Woodson



ZD-60-2057
Fig. WO 3
Woodson



ZD-60-2058
Fig. L2
Ladmore



ZD-60-2059
Fig. L3
Ladmore



FELLING INSTRUMENTS



ZD-60-2060
 Fig. 1
 Ward



ZD-60-2061
 Fig. 2
 Ward



ZD-60-2062
 Fig. 7A

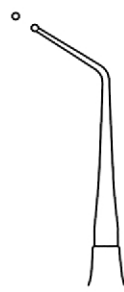

ZD-60-2063
 Fig. 19

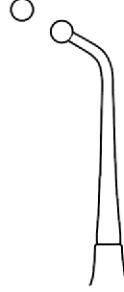

ZD-60-2064
 Fig. 7B



ZD-60-2065
 Fig. 6



ZD-60-2066
 Fig. 11

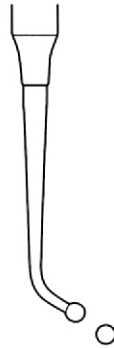

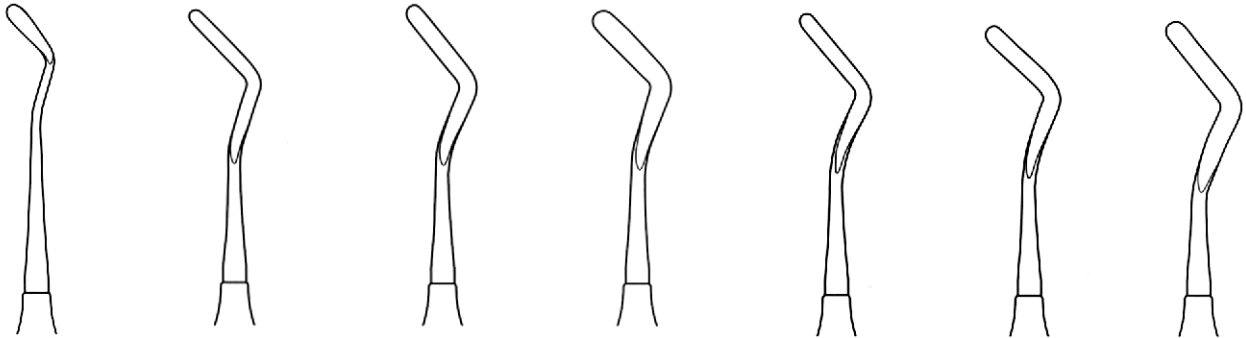

ZD-60-2067
Fig. 179

ZD-60-2068
Fig. 1
2 mm

ZD-60-2069
Fig. 2
2.5 mm

ZD-60-2070
Fig. 3
3 mm

ZD-60-2071
Fig. 11

ZD-60-2072
Fig. 12

ZD-60-2073
Fig. 13

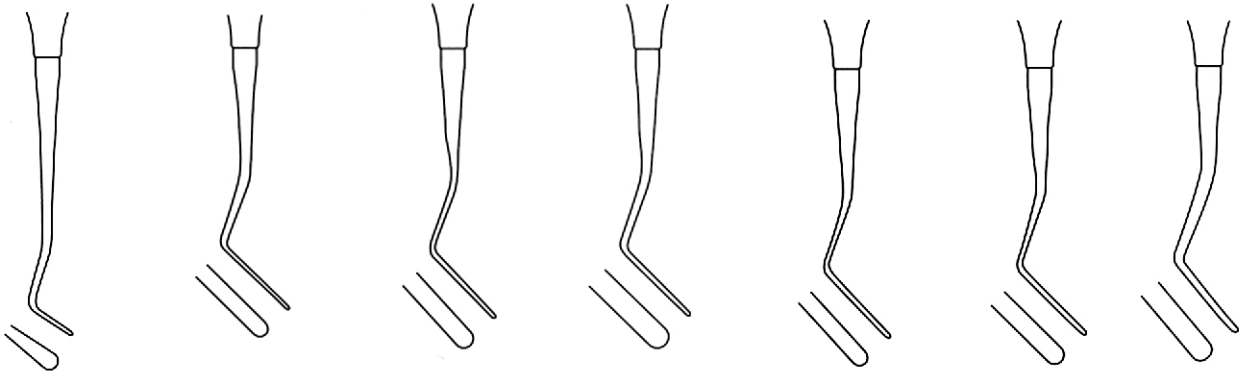

61

- EN** Gingivectomy Knives
- DE** Gingivektomie Messer
- ES** Cuchillos de gingivectomía

Page 106 to 107



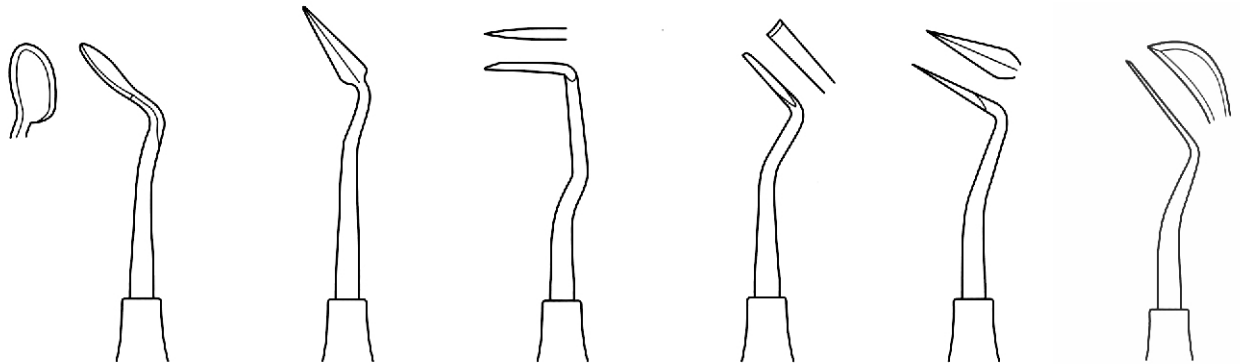

ZD-61-2101
Goldman-Fox
Fig. 7

ZD-61-2102
Goldman-Fox
Fig. 8

ZD-61-2103
Goldman-Fox
Fig. 9

ZD-61-2104
Goldman-Fox
Fig. 10

ZD-61-2105
Goldman-Fox
Fig. 11

ZD-61-2106
Kirkland
Fig. 15K/16K

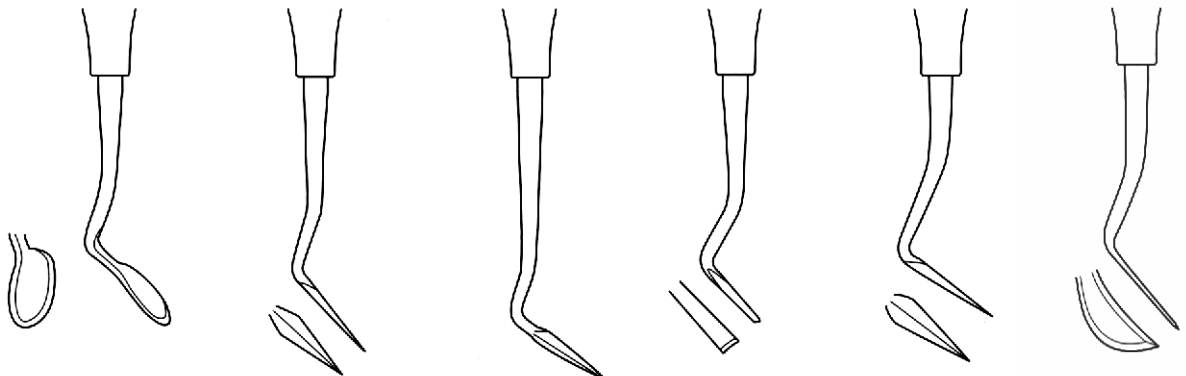

Periodontal Knives ● EN
 Parodontale Messer ● DE
 Cuchillos periodontales ● ES

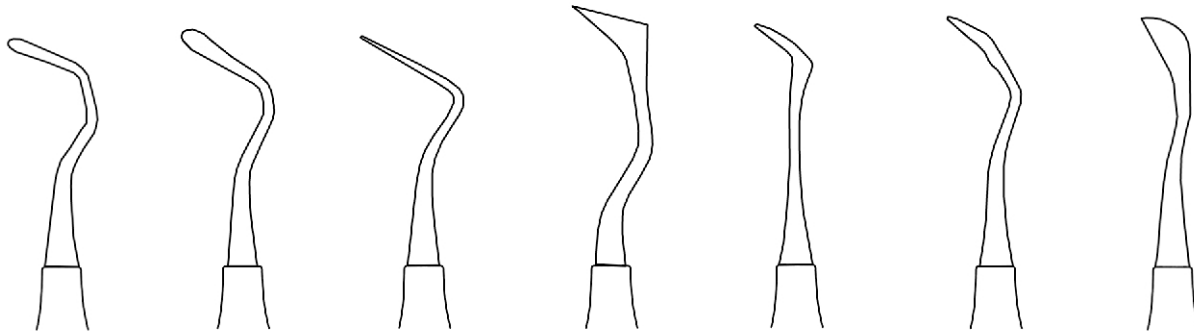

ZD-61-2107
 Fig. 1
 Reddy Thin

ZD-61-2108
 Fig. 2
 Reddy Thin

ZD-61-2109
 Fig. 1/2
 Sanders

ZD-61-2110
 Fig. 19/20
 USC Towner

ZD-61-2111
 Fig. CK-3
 Crane Kaplan

ZD-61-2112
 Fig. CK-6
 Crane Kaplan

ZD-61-2113
 Fig. 1/2
 Solt

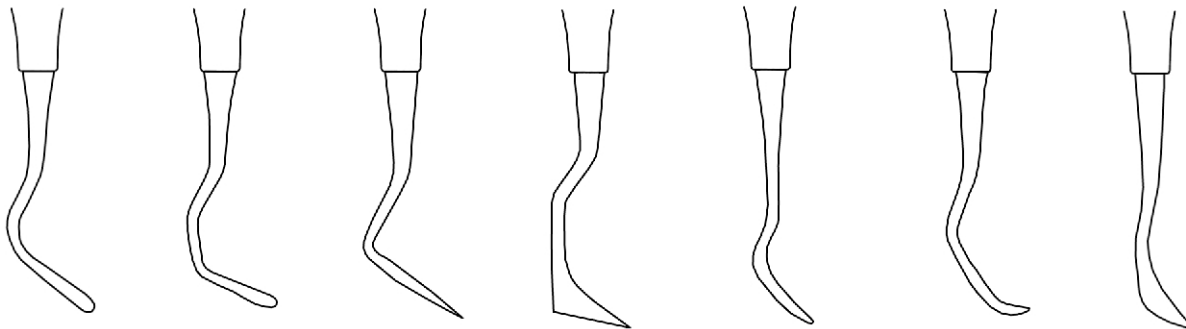

62

- EN** Cement Spatulas
- DE** Zementspatel
- ES** Espátulas de cemento

Page 108 to 112

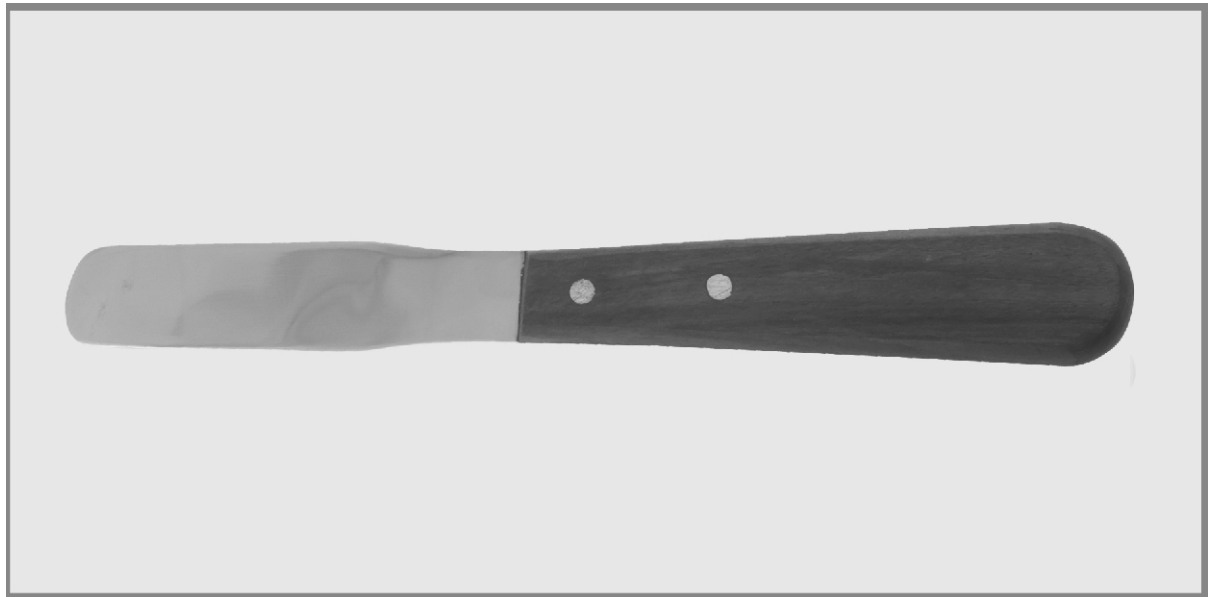



ZD-62-2151
 Fig. 26
 Dista

ZD-62-2152
 Fig. 27
 Mesial

ZD-62-2153
 Fig. 29
 Mesial

ZD-62-2154
 Fig. 29
 Mesial

ZD-62-2155
 Fig. 77/78
 Distal

ZD-62-2156
 Mesial
 54-1142-00

ZD-62-2157
 Fig. 28
 Distal

Wooden Handle



ZD-62-2158
 Fig. 28
 Distal

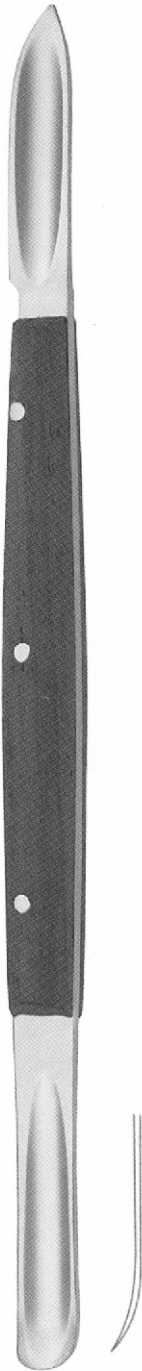

ZD-62-2159
 Fig. 28
 Distal



ZD-62-2160
 Fig. 28
 Distal



ZD-62-2161
 Fig. 28
 Distal

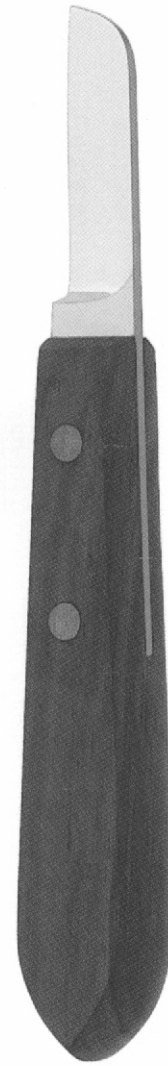

ZD-62-2162
 Fig. 28
 Distal



ZD-62-2163
Fig. 1



Fig. 2



Fig. 3



Fig. 4

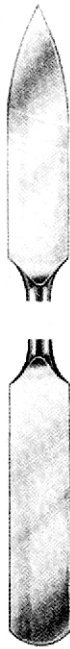

Fig. 5



Fig. 1



Fig. 2
ZD-62-2164



Fig. 3

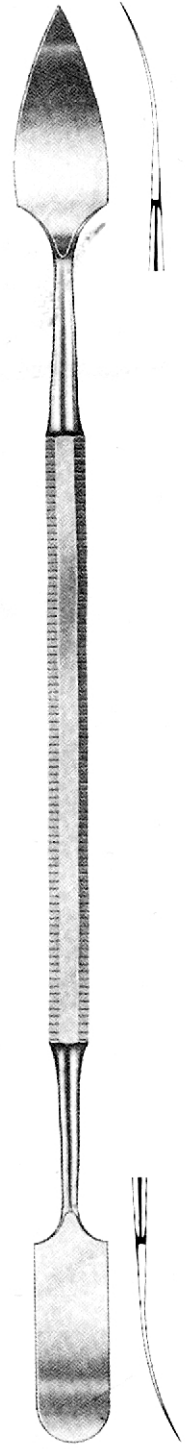

ZD-62-2165
Fig. 31
Gritman

CEMENT SPATULAS



ZD-62-2166
Fig. 1



Fig. 2



Fig. 3



ZD-62-2167
Fig. 1

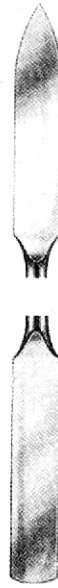

Fig. 2



Fig. 5



Fig. 3



Fig. 6



Fig. 4



Fig. 7



ZD-62-2168
Fig. 1



Fig. 2



Fig. 4



Fig. 5



ZD-62-2169
Fig. 313



Fig. 322



Fig. 324

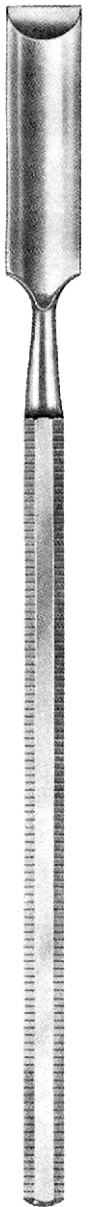

ZD-62-2170



Fig. 6



Fig. 7



Fig. 8



Fig. 5



Fig. 8



Fig. 24 A



Fig. 25 E



Fig. 11

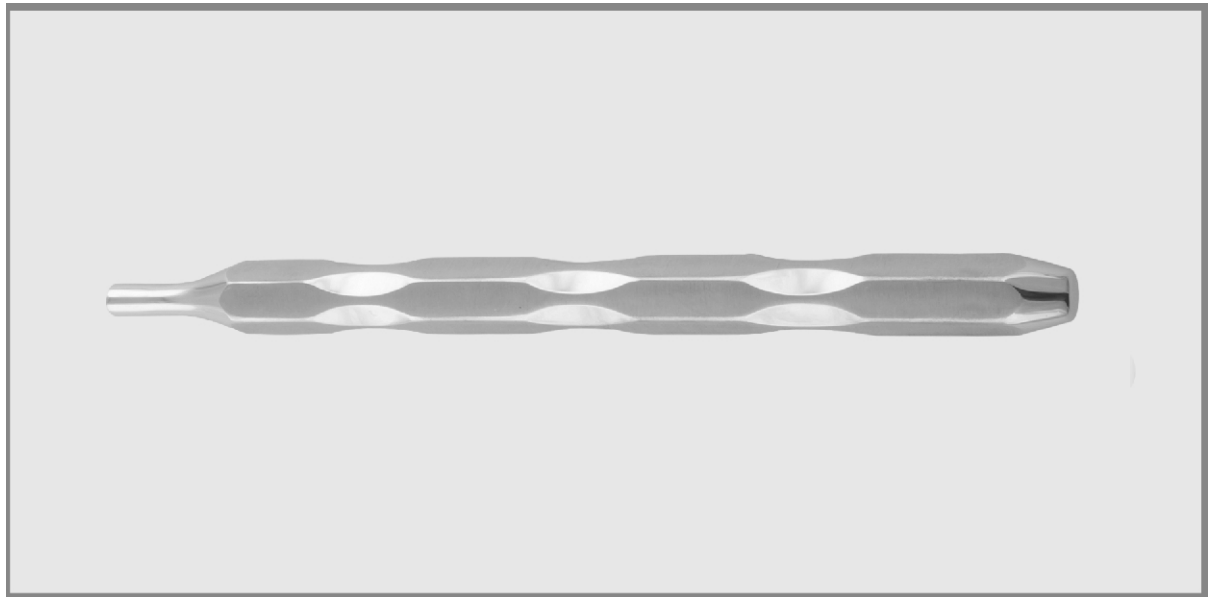

Fig. 12

63

- EN** Mouth Mirrors
- DE** Mundspiegel
- ES** Espejos bucales

Page 113 to 115



Simple Stem



Plain
Magnifying
Front Surface

1 = 16 mm	ZD-63-2301-16
3 = 20 mm	ZD-63-2301-20
4 = 22 mm	ZD-63-2301-22
5 = 24 mm	ZD-63-2301-24



Plain
Magnifying
Front Surface

4 = 22 mm	ZD-63-2302-22
5 = 24 mm	ZD-63-2302-24



Plain
Magnifying
Front Surface

3 = 20 mm	ZD-63-2303-20
4 = 22 mm	ZD-63-2303-22
5 = 24 mm	ZD-63-2303-24

Cone Socket

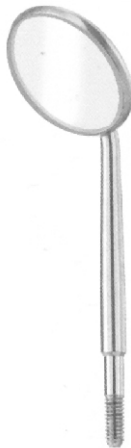

Plain
Magnifying
Front Surface

3 = 20 mm	ZD-63-2304-20
4 = 22 mm	ZD-63-2304-22
5 = 24 mm	ZD-63-2304-24



Plain
Magnifying
Front Surface

3 = 20 mm	ZD-63-2305-20
4 = 22 mm	ZD-63-2305-22
5 = 24 mm	ZD-63-2305-24

MOUTH MIRRORS



ZD-63-2306-01
 4,5 cm/13/4



ZD-63-2306-02
 Handle only

HILGER
 ZD-63-2306-00
 18 cm/7"



ZD-63-2307-14
 Hollow



ZD-63-2308-14
 Hollow



ZD-63-2309-14
 Hollow

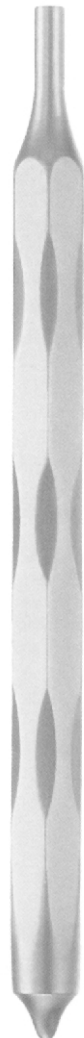

ZD-63-2310-14
 Hollow

Mirror handles are available with Cone Socket and Simple Stem Fittings
 Matric / US Threads, Please specify while ordering



ZD-63-2311-12
Hollow



ZD-63-2312-12
Solid



ZD-63-2313-12
Solid



ZD-63-2314-12
Solid



ZD-63-2315-00
Solid



ZD-63-2316-00
Hollow

Mirror handles are available with Cone Socket and Simple Stem Fittings
 Metric / US Threads, Please specify while ordering

64

- EN** Amalgam Instruments
- DE** Amalgam Instrumente
- ES** Instrumentos de amalgama

Page 116 to 117

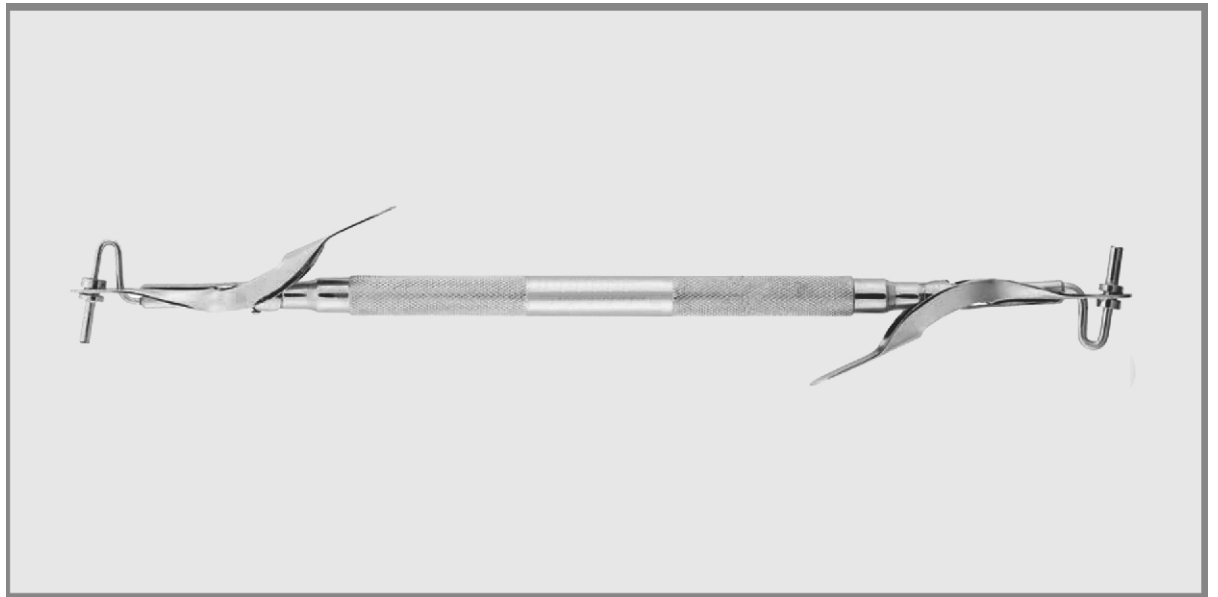

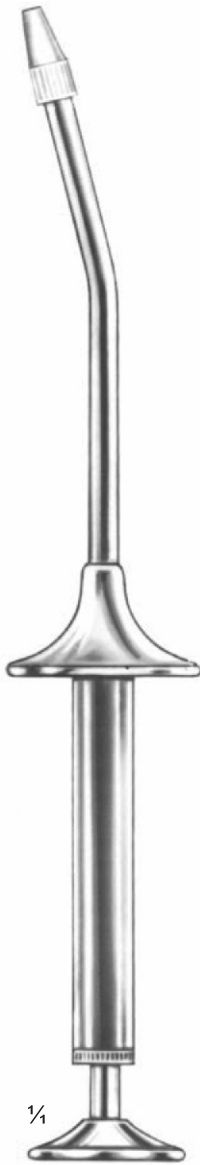

¼

with metal tip ZD-64-2351
 with plastic tip ZD-64-2352

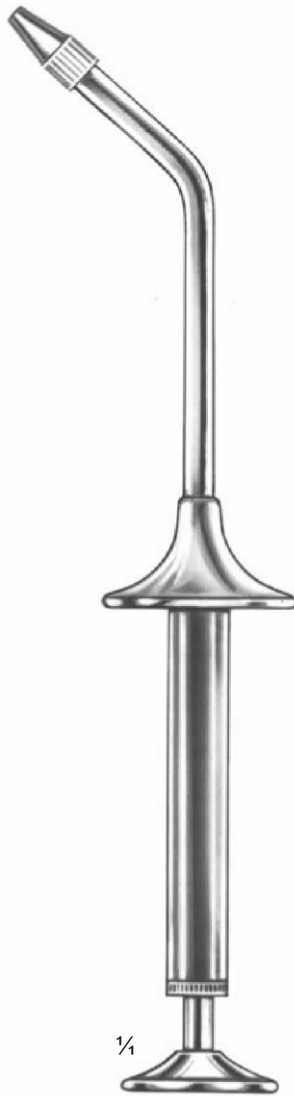

¼

ZD-64-2353
 ZD-64-2354

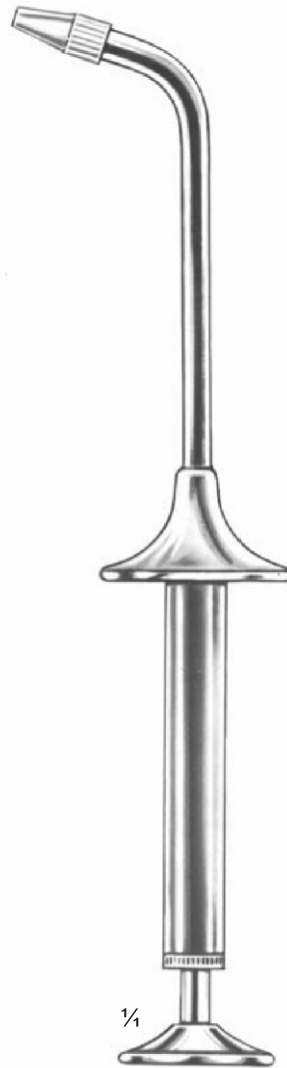

¼

ZD-64-2355
 ZD-64-2356



¼

ZD-64-2357
 ZD-64-2358

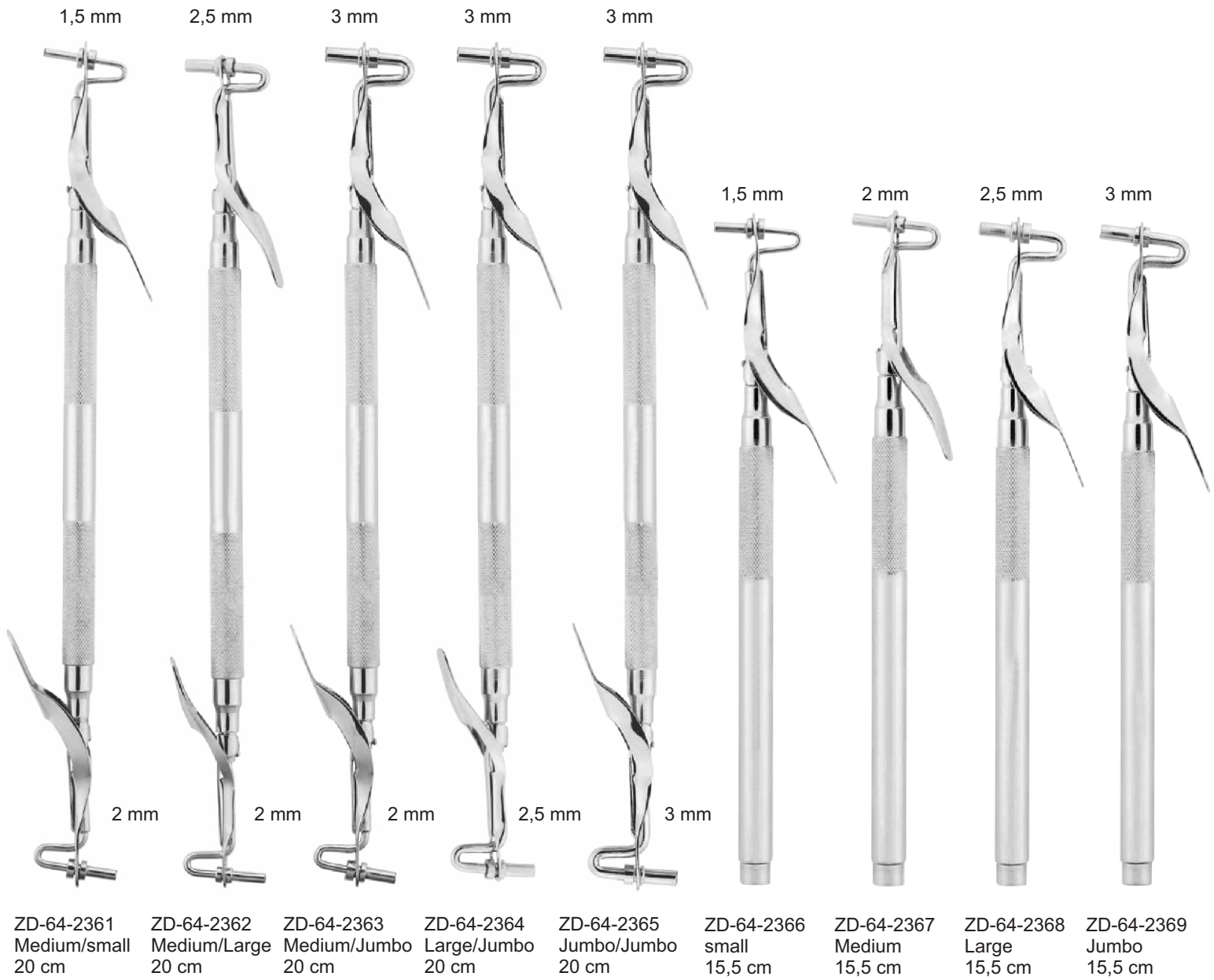

ZD-64-2361
 Medium/small
 20 cm

ZD-64-2362
 Medium/Large
 20 cm

ZD-64-2363
 Medium/Jumbo
 20 cm

ZD-64-2364
 Large/Jumbo
 20 cm

ZD-64-2365
 Jumbo/Jumbo
 20 cm

ZD-64-2366
 small
 15,5 cm

ZD-64-2367
 Medium
 15,5 cm

ZD-64-2368
 Large
 15,5 cm

ZD-64-2369
 Jumbo
 15,5 cm

65

- EN** Matrix Retainers
- DE** Matrix-Halterungen
- ES** Retenedores de matrices

Page 118 to 125





Tofflemire-Universal
 ZD-65-2601



Tofflemire-Senior
 ZD-65-2602



Tofflemire-Junior
 ZD-65-2603



Fig.1
 Nystrom
 left
 ZD-65-2604



Fig.2
 Nystrom
 right
 ZD-65-2605



Ivory 8
 ZD-65-2606 5 mm
 ZD-65-2607 6 mm
 ZD-65-2608 7 mm



Ivory 8N
 ZD-65-2609



Didner 8P
 ZD-65-2610

adjustable

MATRIX RETAINERS

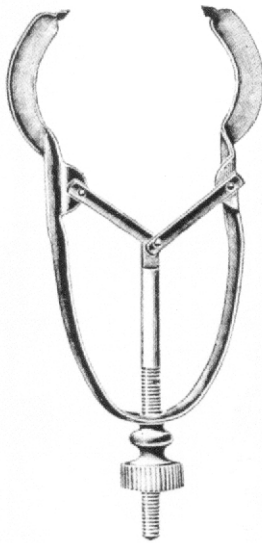

Ivory
 ZD-65-2611
 Fig. 1

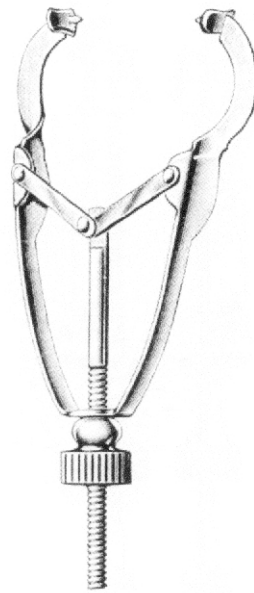

Ivory
 ZD-65-2612
 Fig. 12



Ivory
 ZD-65-2613
 Fig. 12A



Ainsworth
 ZD-65-2614
 16 cm / 6 1/2"



Ainsworth
 ZD-65-2615
 16 cm / 6 1/2"



Ivory
 ZD-65-2616
 15 cm / 6"



Ivory
 ZD-65-2617
 15 cm / 6"



Ivory
 ZD-65-2618
 17 cm / 6 3/4"



Brewer
 ZD-65-2619
 17 cm / 6 3/4"

MATRIX RETAINERS



Stockes
 ZD-65-2620
 17 cm / 6 3/4"

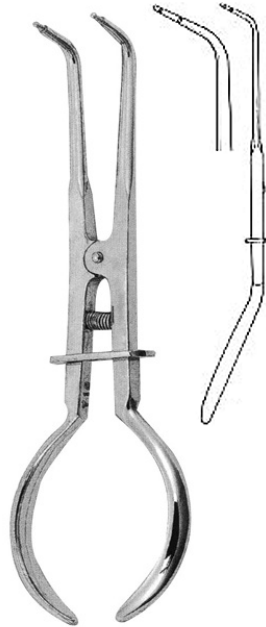

Stockes
 ZD-65-2621
 17 cm / 6 3/4"



Palmer
 ZD-65-2622
 17 cm / 6 3/4"



White
 ZD-65-2623
 17 cm / 6 3/4"



Band Pusher-Mershon
 ZD-65-2624
 14 cm / 5 1/2"



ZD-65-2626
Fig. 00
Anterior Teeth



ZD-65-2627
Fig. 0
Premolars



ZD-65-2628
Fig. 1
Premolars



ZD-65-2629
Fig. 1A
Premolars



ZD-65-2630
Fig. 2
Premolars



ZD-65-2631
Fig. 2A
Premolars



ZD-65-2632
Fig. 2AS
Premolars



ZD-65-2633
Fig. 3
Lower Molars



ZD-65-2634
Fig. 4
Upper Molars



ZD-65-2635
Fig. 5
Upper Molars



ZD-65-2636
Fig. 6
Anterior Teeth



ZD-65-2637
Fig. 7
Lower Molars



ZD-65-2638
Fig. 7A
Lower Molars



ZD-65-2639
Fig. 8
Upper Molars



ZD-65-2640
Fig. 8A
Molars General



ZD-65-2641
Fig. 9
Anterior Teeth



ZD-65-2642
Fig. 9S
Anterior Teeth



ZD-65-2643
Fig. 10
Molars General



ZD-65-2644
Fig. 11
Molars General



ZD-65-2645
Fig. 24
Molars General



ZD-65-2646
Fig. 25
Molars General



ZD-65-2647
Fig. 26
Lower Molars



ZD-65-2648
Fig. 26N
Molars General



ZD-65-2649
Fig. 27
Molars General

MATRIX RETAINERS



ZD-65-2650
 Fig. 27N
 Premolars



ZD-65-2651
 Fig. 28
 Lower Molars



ZD-65-2652
 Fig. 29
 Lower Molars



ZD-65-2653
 Fig. 30
 Upper Molars



ZD-65-2654
 Fig. 31
 Upper Molars



ZD-65-2655
 Fig. 56
 Molars General



ZD-65-2656
 Fig. 56S
 Molars General



ZD-65-2657
 Fig. 201
 Upper Molars



ZD-65-2658
 Fig. 205
 Upper Molars



ZD-65-2659
 Fig. 212
 Anterior Teeth



ZD-65-2660
 Fig. 212SA
 Anterior Teeth



ZD-65-2661
 Premolars
 12-06ZD-65-W2



ZD-65-2662
 Fig. W3
 Lower Molars



ZD-65-2663
 Fig. W4
 Upper Molars



ZD-65-2664
 Fig. W7
 Lower Molars

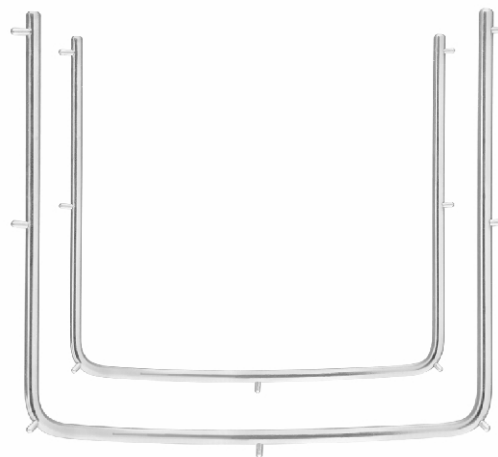

ZD-65-2665 Frame - Child
 13 cm/5"
 ZD-65-2666 Frame - Adult
 15 cm/6"

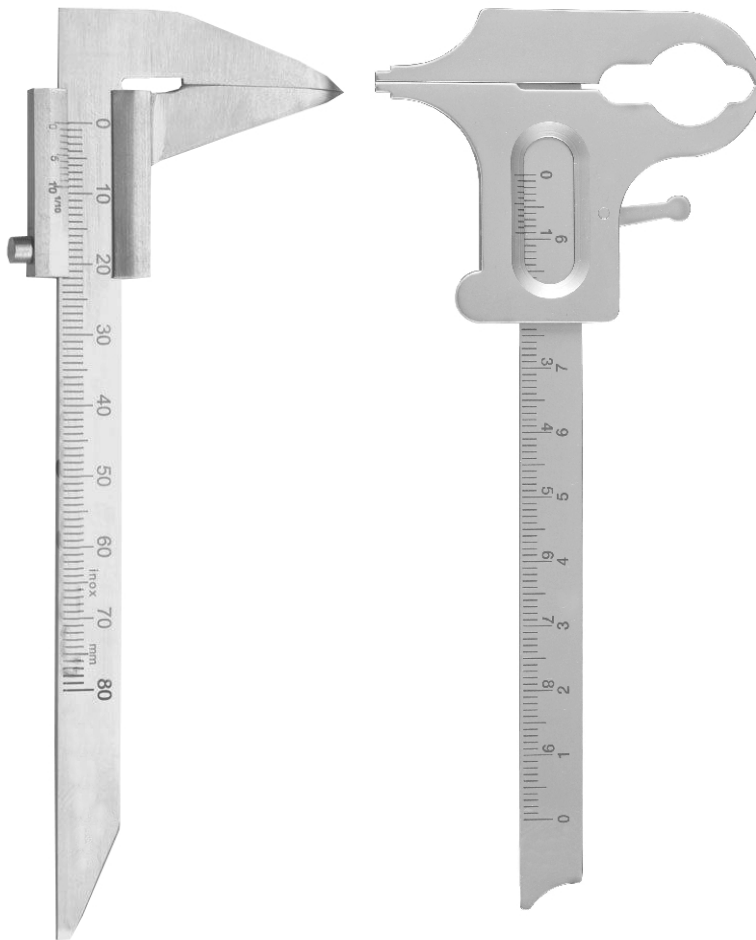

ZD-65-2667
Beerendonk

ZD-65-2668
Boley



Iwanson
One side graugation
ZD-65-2669 Metal
ZD-65-2670 Wax

Double side graugation
ZD-65-2671 Metal
ZD-65-2672 Wax

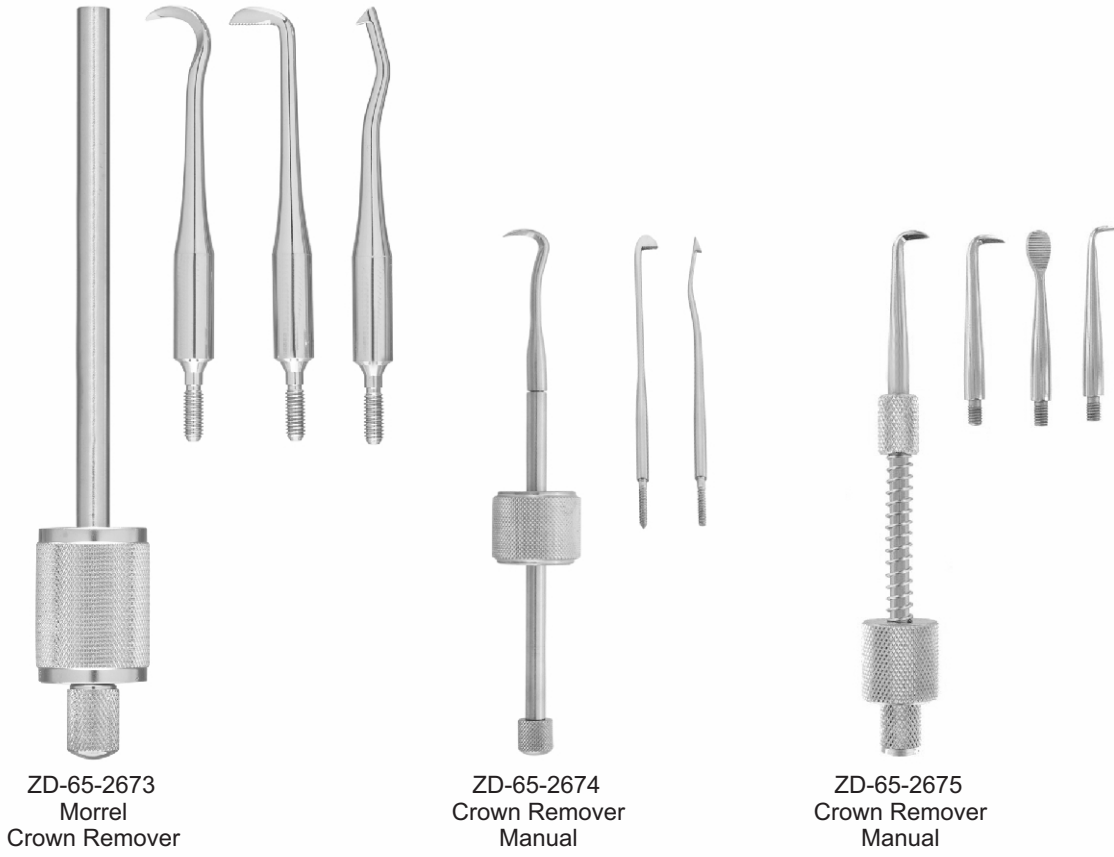

66

- EN** Hemostatic Forceps
- DE** Arterienklemmen
- ES** Pincas hemostaticas

Page 126 to 132

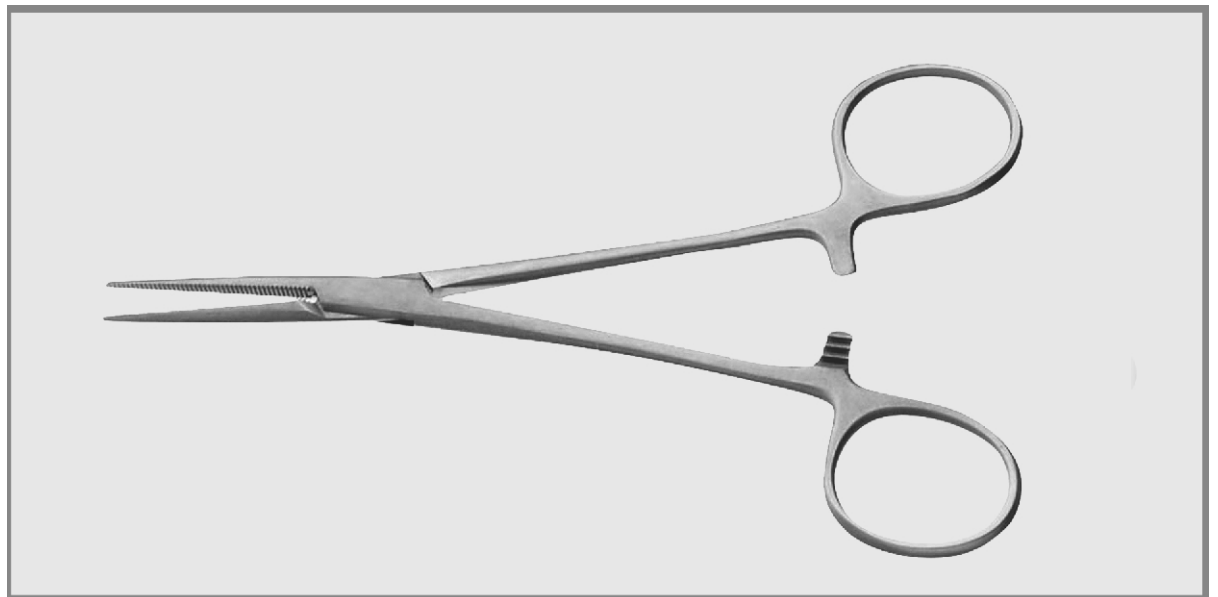



Halsted-Mosquito



ZD-66-2701
12.5 cm/5"



ZD-66-2702
14.5 cm/5 3/4"



ZD-66-2703
14 cm/5 1/2"



ZD-66-2704
12.5 cm/5"
1:2



ZD-66-2705
14.5 cm/5 3/4"
1:2



ZD-66-2706
12 cm/4 3/4"
1:2



ZD-66-2707
14 cm/4 1/2"
1:2



Micro-Mosquito



ZD-66-2708
10 cm/4"



ZD-66-2709
12 cm/4 3/4"



ZD-66-2710
9.5 cm/3 1/2"



ZD-66-2711
11.5 cm/4 1/2"



ZD-66-2712
10 cm/4"
1:2



ZD-66-2713
12 cm/4 3/4"
1:2



ZD-66-2714
10 cm/4"
1:2



ZD-66-2715
12 cm/4 3/4"
1:2

ARTERY FORCEPS

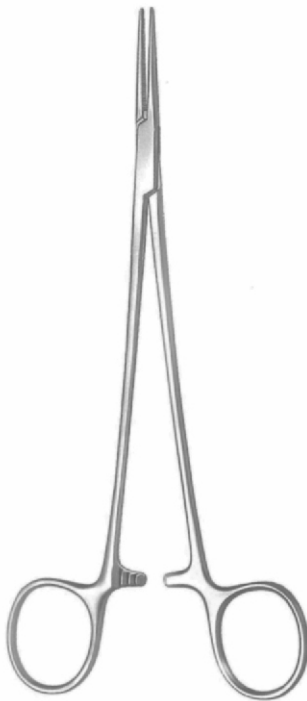

Halsted-Mosquito



ZD-66-2716
18 cm/7"

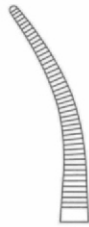

ZD-66-2717
18 cm/7"



ZD-66-2718
18 cm/7"
1:2



ZD-66-2719
18 cm/7"
1:2

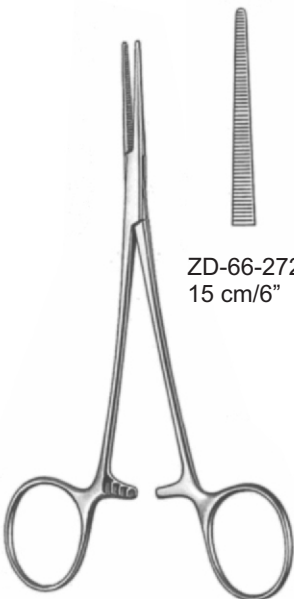

Leriche



ZD-66-2720
15 cm/6"

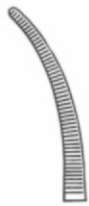

ZD-66-2721
15 cm/6"



ZD-66-2722
15 cm/6"
1:2

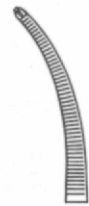

ZD-66-2723
15 cm/6"
1:2

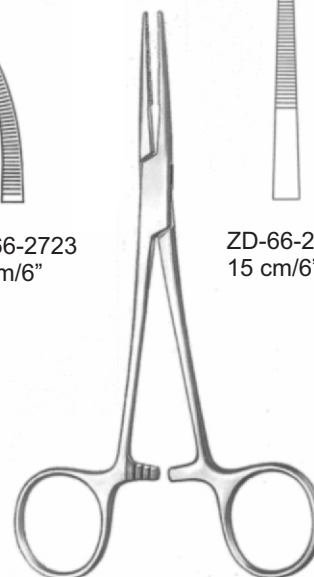

Kelly



ZD-66-2724
15 cm/6"

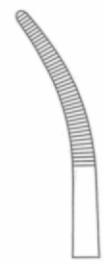

ZD-66-2725
15 cm/6"

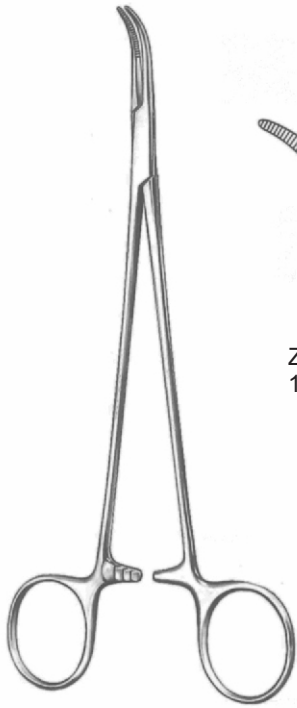

Mixer-Baby

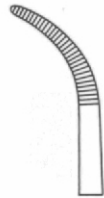

ZD-66-2726
 18.5 cm/7 ¼"

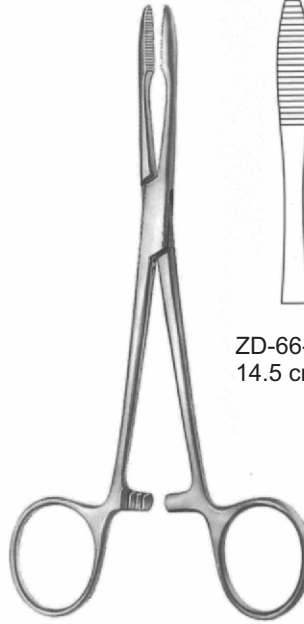

Pean



ZD-66-2727
 14.5 cm/5 ¾"



ZD-66-2728
 16 cm/6 ¼"



Pean



ZD-66-2729
 13 cm/5"



ZD-66-2730
 14 cm/5 ½"

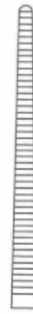

ZD-66-2731
 17 cm/6 ¾"



ZD-66-2732
 13 cm/5"



ZD-66-2733
 14 cm/5 ½"



ZD-66-2734
 17 cm/6 ¾"

Artery Forceps ● EN
 Arterienklemmen ● DE
 Pinzas hemostáticas ● ES

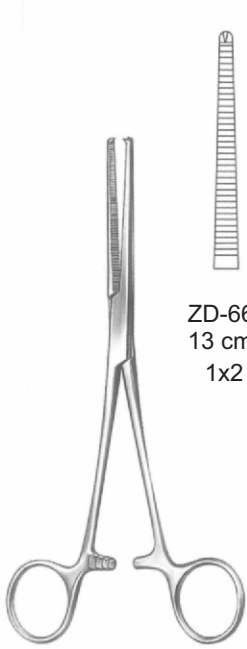

Kocher

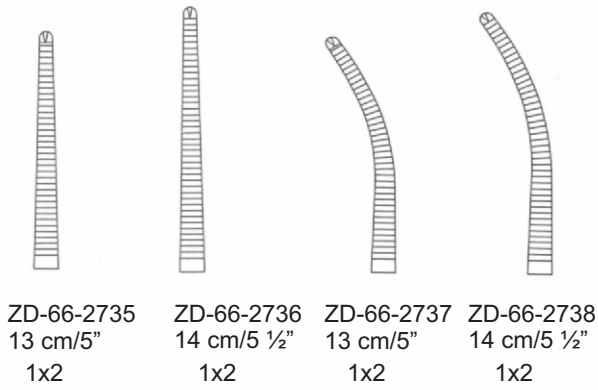

ZD-66-2735 13 cm/5" 1x2
 ZD-66-2736 14 cm/5 1/2" 1x2
 ZD-66-2737 13 cm/5" 1x2
 ZD-66-2738 14 cm/5 1/2" 1x2

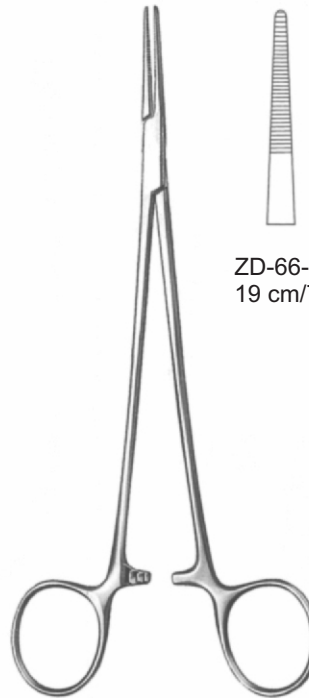

Adson

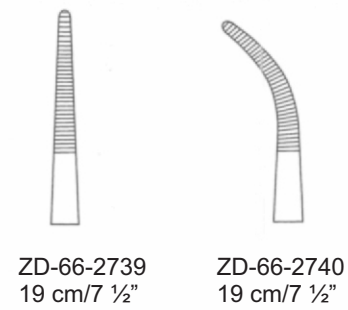

ZD-66-2739 19 cm/7 1/2"
 ZD-66-2740 19 cm/7 1/2"



Gross-Maier

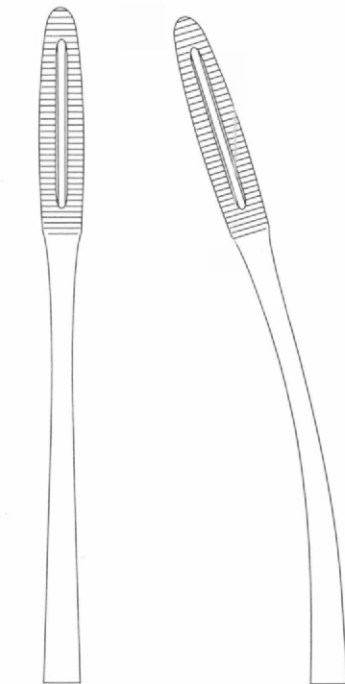

ZD-66-2741 20 cm/8"
 ZD-66-2742 20 cm/8"



DeBakey-Mosquito

ATRAUMA

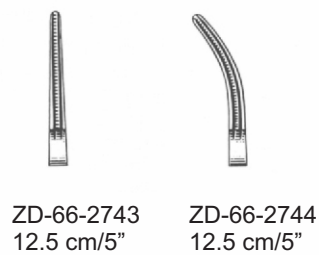

ZD-66-2743 12.5 cm/5"
 ZD-66-2744 12.5 cm/5"

ARTERY FORCEPS

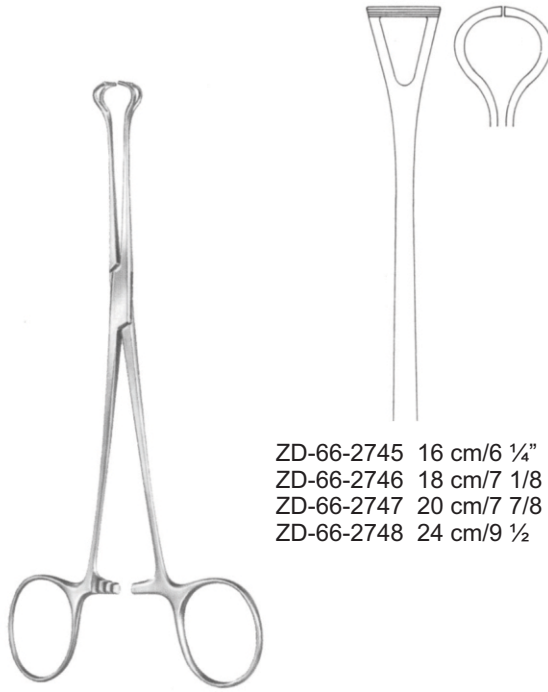

ZD-66-2745 16 cm/6 1/4"
 ZD-66-2746 18 cm/7 1/8
 ZD-66-2747 20 cm/7 7/8
 ZD-66-2748 24 cm/9 1/2

Babcock



ZD-66-2749 TC
 16 cm/6 1/2



Babcock

ATRAUMA

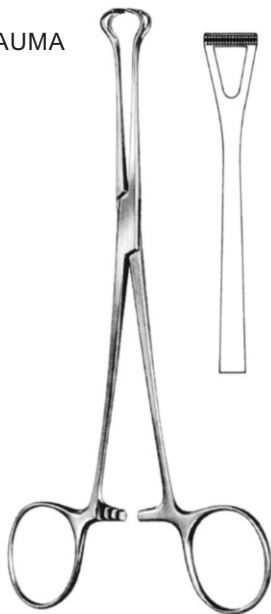

BABCOCK
 ZD-66-2750
 16 cm/9 1/4

ATRAUMA

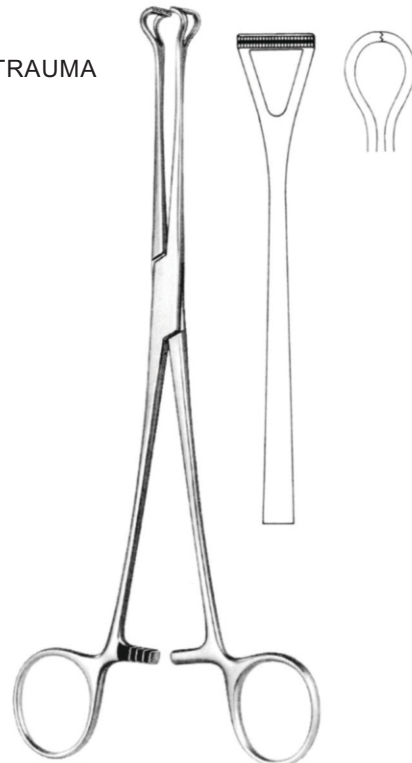

BABCOCK
 ZD-66-2751
 20.5 cm/8 1/8

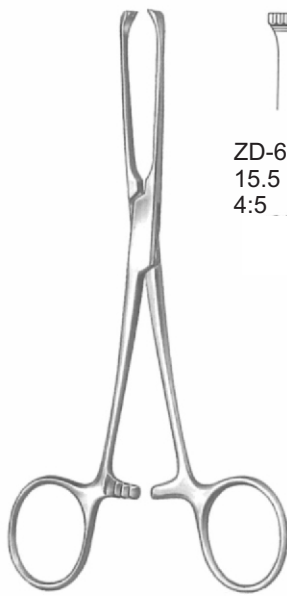

Allis



ZD-66-2752
 15.5 cm/6"
 4:5



ZD-66-2753
 15.5 cm/6"
 5:6



ZD-66-2754
 19 cm/7 1/2"
 5:6

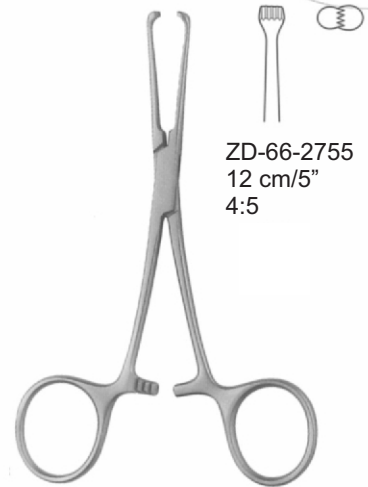

Allis-Baby



ZD-66-2755
 12 cm/5"
 4:5

ATRAUMA

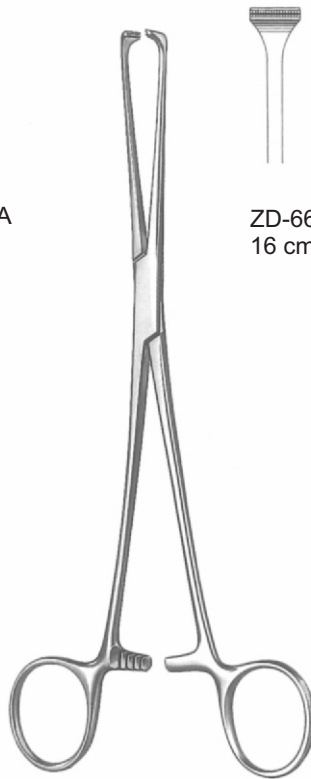

ZD-66-2756
16 cm/6 1/2"

ZD-66-2757
20 cm/8"

Allis

67

- EN** Towel Clamps
- DE** Handtuchklammern
- ES** Abrazaderas de toalla

Page 133 to 134

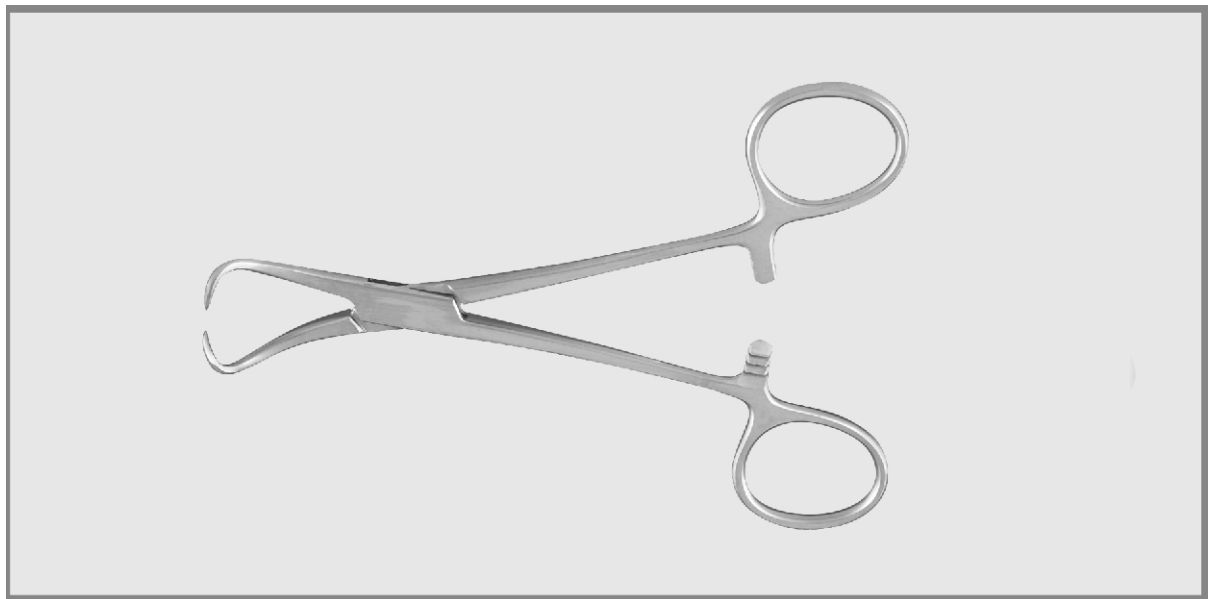

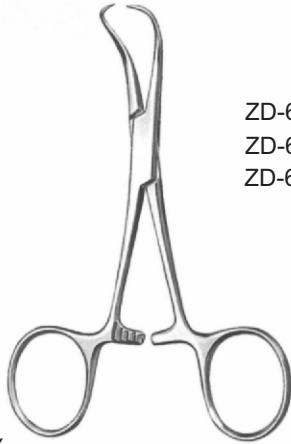

1/2

Backhaus

ZD-67-2801 9 cm/3 1/2"
 ZD-67-2802 11.5 cm/4 1/2"
 ZD-67-2803 13 cm/5"



1/2

for paper clothes

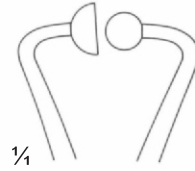

1/4

ZD-67-2804
 11.5 cm/4 1/2"

ZD-67-2805
 14 cm/5 1/2"



1/2

Peers-Bertrom
 ZD-67-2806
 14.5 cm/5 3/4"



1/4

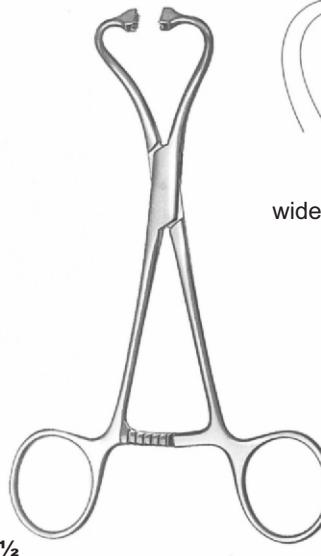

1/2

Peers-Bertram modif.
 ZD-67-2807
 15.5 cm/6"

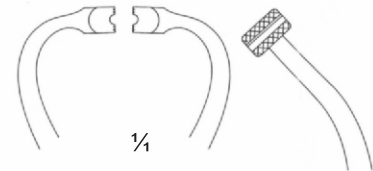

1/4

wide jaw for tube fixation

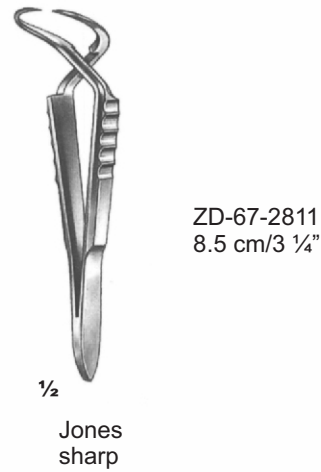
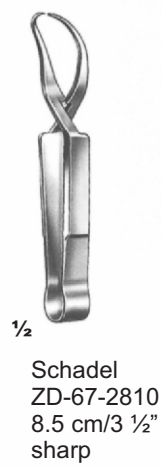
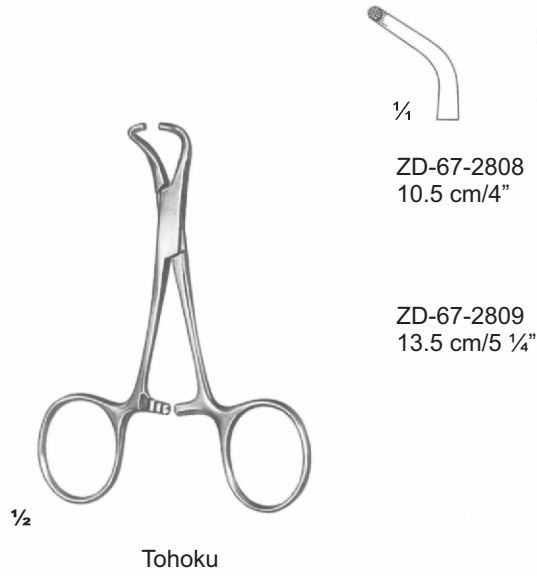

68

- EN** Needle Holders
- DE** Nadelhalter
- ES** Porte-aiguilles

Page 135 to 143



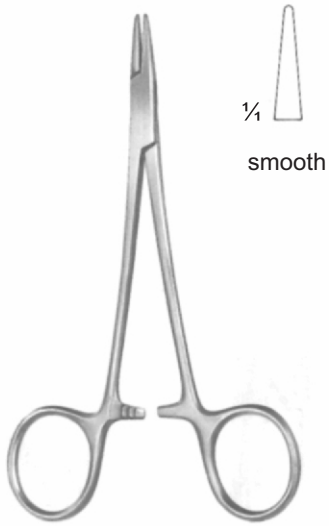

Webster
 ZD-68-2901
 13 cm/5 1/8"

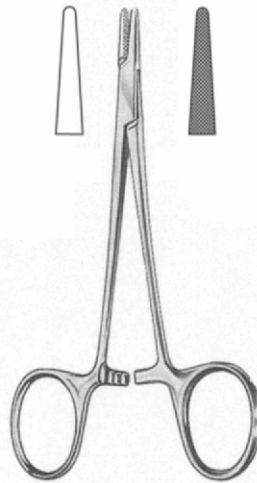

Halsey
 ZD-68-2902 13 cm/5 1/8" Plain
 ZD-68-2903 13 cm/5 1/8" Serrated

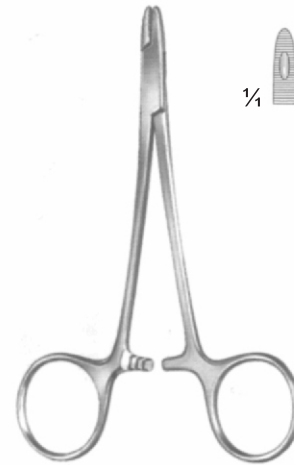

Derf
 ZD-68-2904
 12 cm/4 3/4"
 one fenestrated jaw



Crile-Wood
 ZD-68-2905
 15 cm/5 7/8"



Crile-Murray
 ZD-68-2906
 15 cm/5 7/8"
 slender pattern

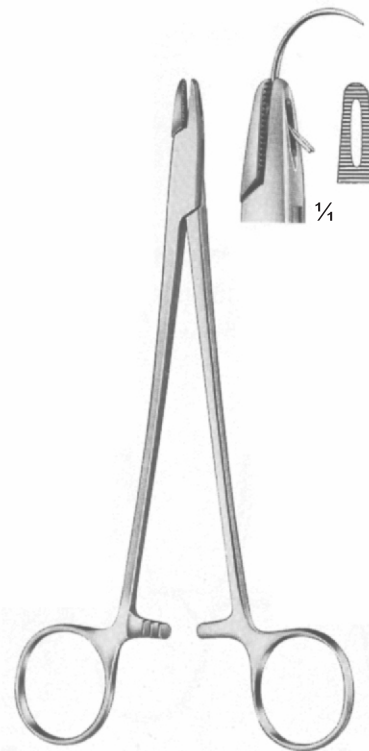

Adson
 ZD-68-2907
 18 cm/7 1/8"
 one fenestrated jaw

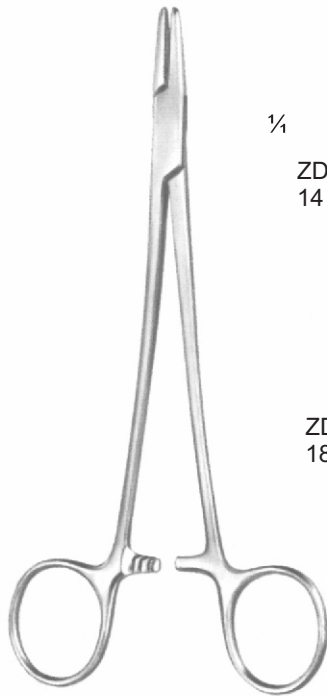

MAYO-HEGAR

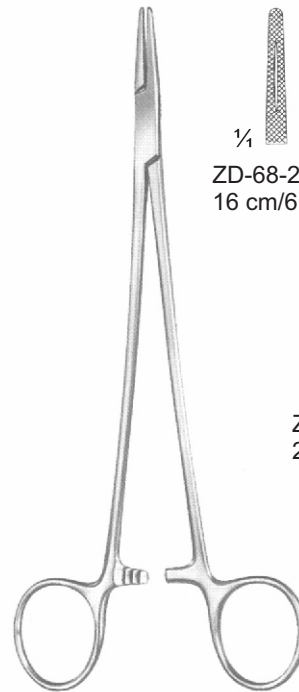
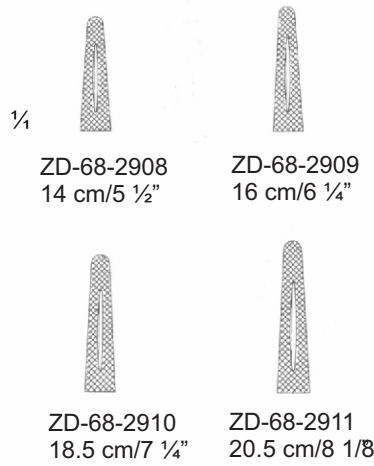

MAYO-HEGAR
slender pattern

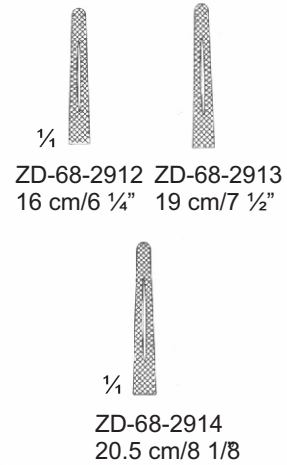

HEGAR-BAUMGARTNER
ZD-68-2915
14 cm/5 1/2"

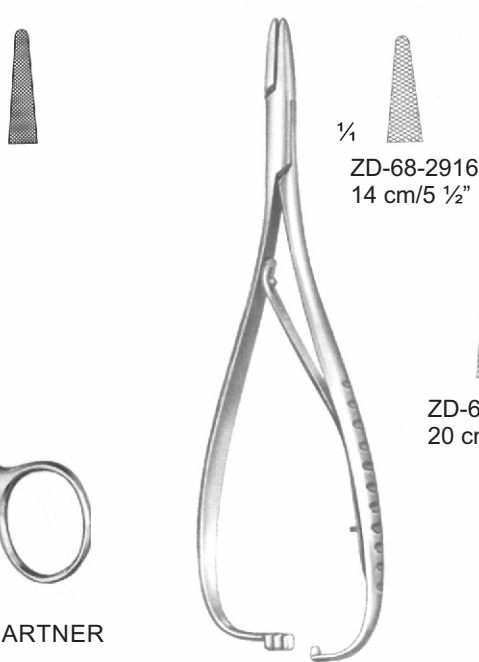

MATHIEU

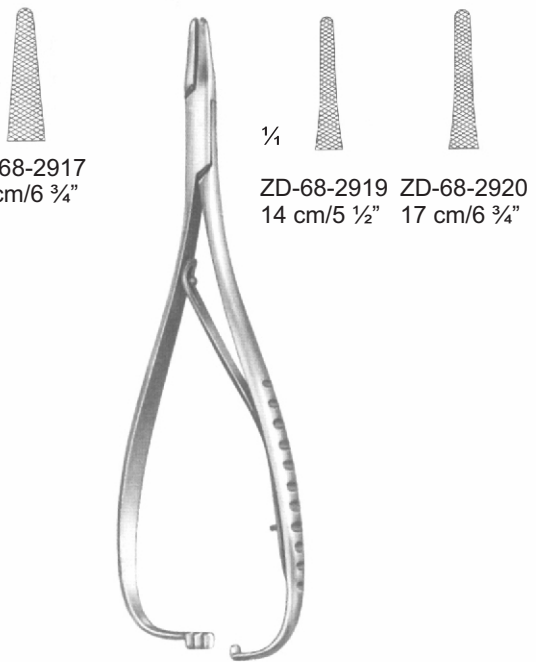

MATHIEU
slender pattern



Lichtenberg
 ZD-68-2921
 20 cm/7 7/8"



Toennis
 ZD-68-2922
 18.5 cm/7 1/4"



Crile
 ZD-68-2923
 15 cm/5 7/8"

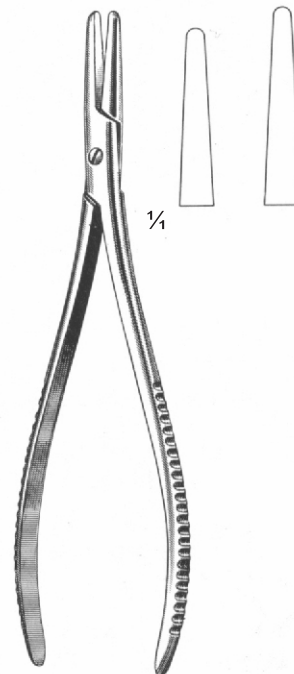

Langenbeck
 ZD-68-2924 16 cm/6 1/4"
 ZD-68-2925 20 cm/7 7/8"

Needle Holders ● EN
 Nadelhalter ● DE
 Porta agujas ● ES

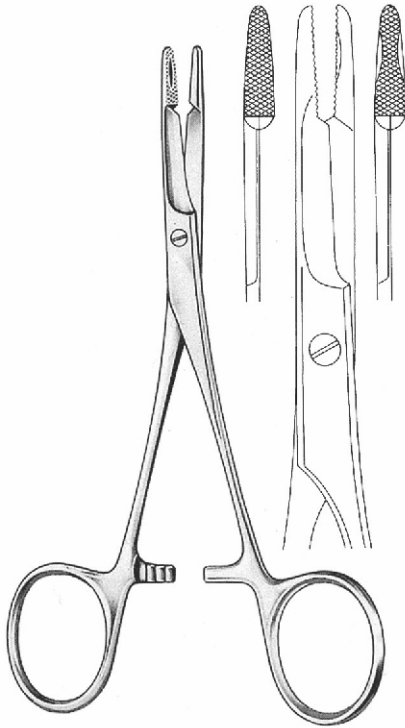

Olsen-Hegar

ZD-68-2926 11 cm/4 3/8"

ZD-68-2927 14 cm/5 1/2"

ZD-68-2928 18 cm/7 1/8"

ZD-68-2929 19 cm/7 1/2"

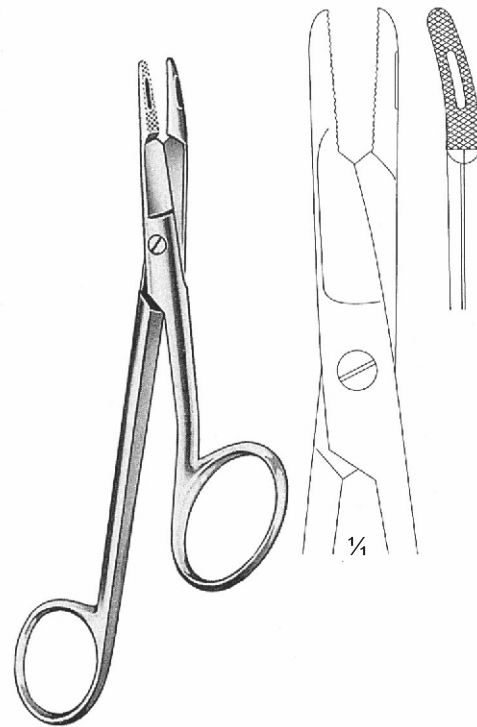

Gillies

ZD-68-2930 Right hand

ZD-68-2931 Left hand
 16 cm/6 1/4"



$\frac{1}{4}$ 
 ZD-68-2932
 13 cm/5 1/8
 smooth jaw

HALSEY

 ZD-68-2933
 13 cm/5 1/8
 0.4 mm

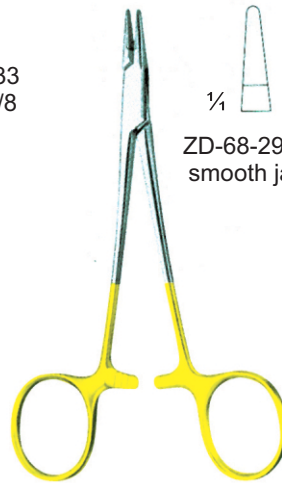

$\frac{1}{4}$ 
 ZD-68-2934
 smooth jaw

WEBSTER
 12.5 cm/4 7/8"

 ZD-68-2935
 0.4 mm



$\frac{1}{4}$ 
 0.4 mm

DERF
 ZD-68-2936
 12 cm/4 3/4"





 0.5 mm

Toennis
 ZD-68-2937
 18 cm/7 1/8



 0.5 mm
 ZD-68-2938
 18.5 cm/7 1/4"



 0.5 mm
 ZD-68-2939
 20.5 cm/8 1/8

 0.5 mm
 ZD-68-2940
 23 cm/9"

Langenbeck

NEEDLE HOLDERS

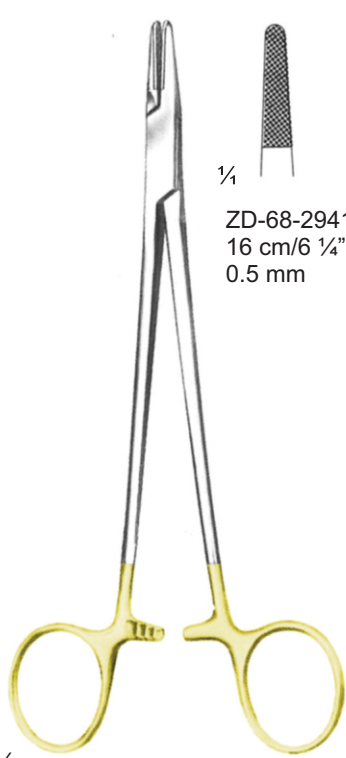
Needle Holders ● EN
 Nadelhalter ● DE
 Porta agujas ● ES



1/2

Mayo-Hegar
standard profile

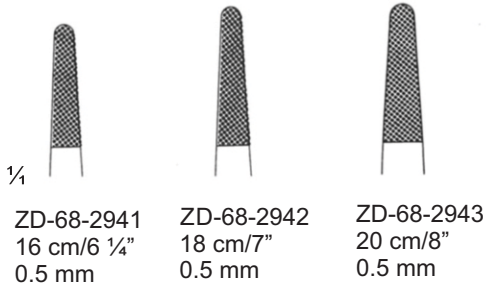

ZD-68-2941
16 cm/6 1/4"
0.5 mm

ZD-68-2942
18 cm/7"
0.5 mm

ZD-68-2943
20 cm/8"
0.5 mm

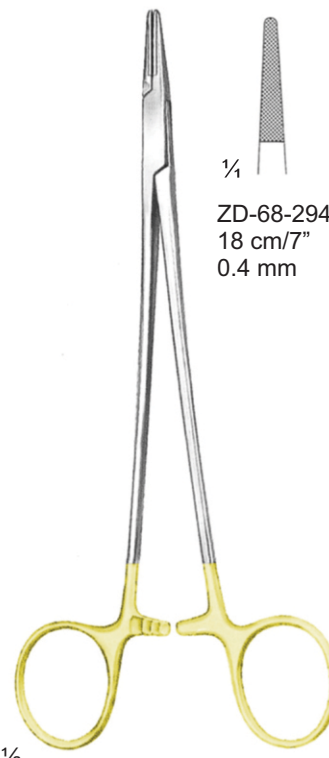

1/2

Debakey
mini profile

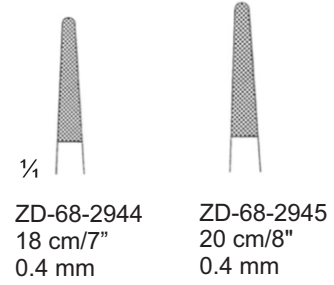

ZD-68-2944
18 cm/7"
0.4 mm

ZD-68-2945
20 cm/8"
0.4 mm

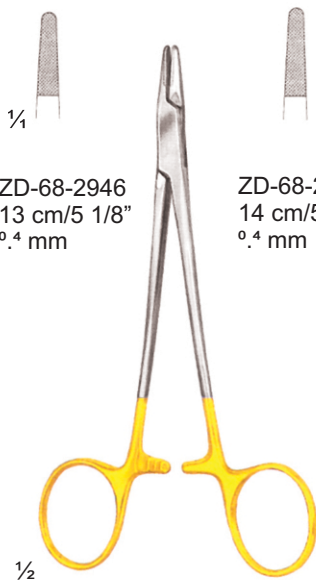

1/2

HEGAR-BAUMGARTNER

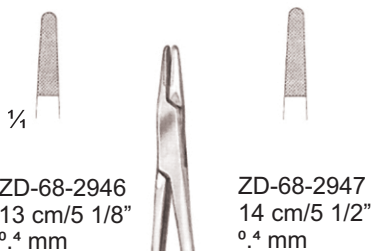

ZD-68-2946
13 cm/5 1/8"
0.4 mm

ZD-68-2947
14 cm/5 1/2"
0.4 mm



1/2

Mathieu
Standard Profile

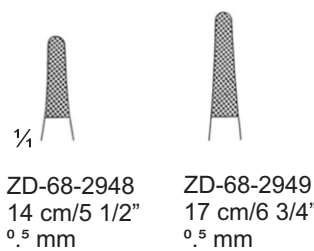

ZD-68-2948
14 cm/5 1/2"
0.5 mm

ZD-68-2949
17 cm/6 3/4"
0.5 mm



ZD-68-2950
20 cm/8"
0.5 mm



1/2

Mathieu
Standard Profile

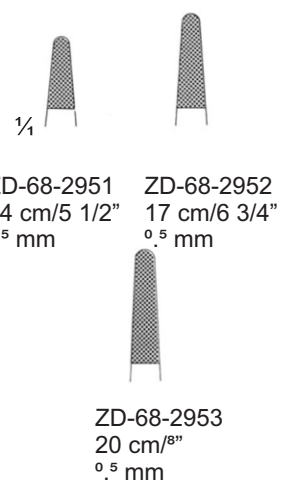

ZD-68-2951
14 cm/5 1/2"
0.5 mm

ZD-68-2952
17 cm/6 3/4"
0.5 mm

ZD-68-2953
20 cm/8"
0.5 mm



1/2

Mathieu



ZD-68-2954	ZD-68-2955	ZD-68-2956
17 cm/6 3/4"	20 cm/8"	23 cm/9"
0.5 mm	0.5 mm	0.5 mm

with interior ratchet
 standard profile

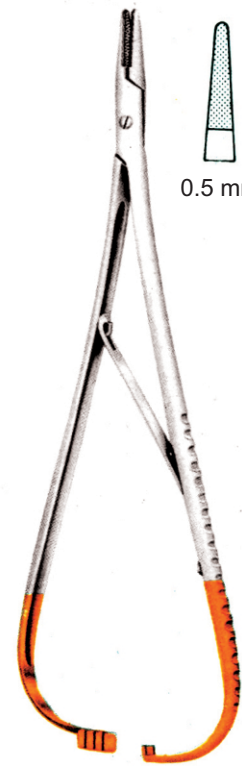

0.5 mm

Lichtenberg
 ZD-68-2957
 20 cm/7 7/8"



1/2

Zweifel



ZD-68-2958	ZD-68-2959
20.5 cm/8"	23 cm/9"
0.5 mm	0.5 mm

with hinged rehet
 Standard Profile

1/2

ZD-68-2960
 14.5 cm/5 3/4"
 0.5 mm

ZD-68-2961
 17 cm/6 3/4"
 0.5 mm

ZD-68-2962
 19 cm/9 1/2"
 0.5 mm
 standard profile

Olsen-Hegar

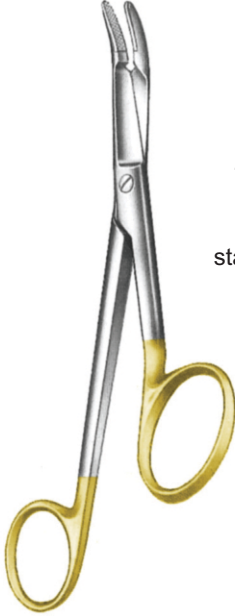

1/4

ZD-68-2963
 16 cm/6 1/4"
 0.5 mm
 standard profile

Gillies



1/4

ZD-68-2964
 11 cm/4 1/4"
 smooth jaw

Foster-Gillies



1/4

ZD-68-2965
 15 cm/6"
 0.4 mm
 mini profile

Gillies-Mini

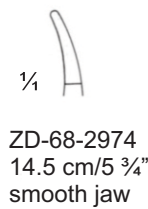
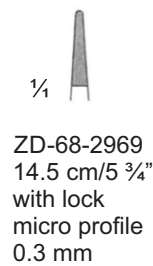
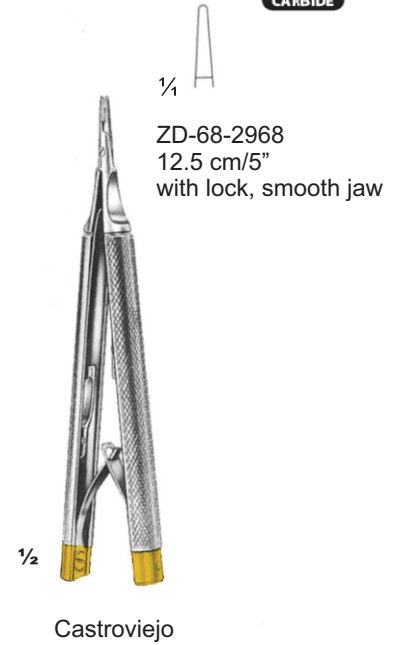

69

- EN** Retractors
- DE** Wundhaken
- ES** Ecarteurs

Page 144 to 148

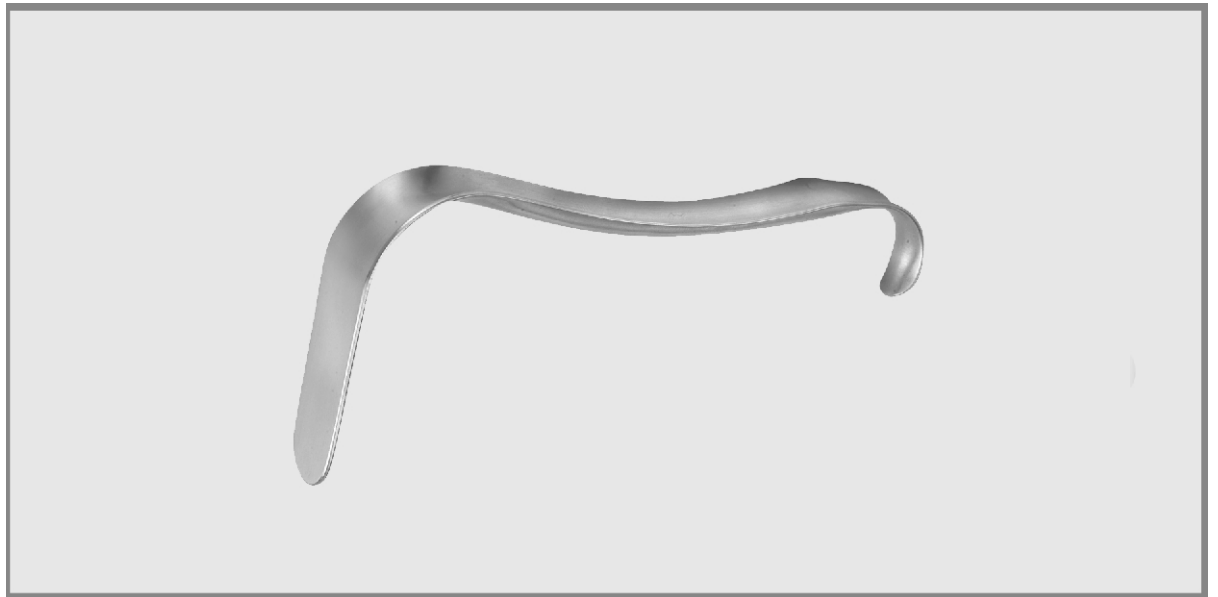

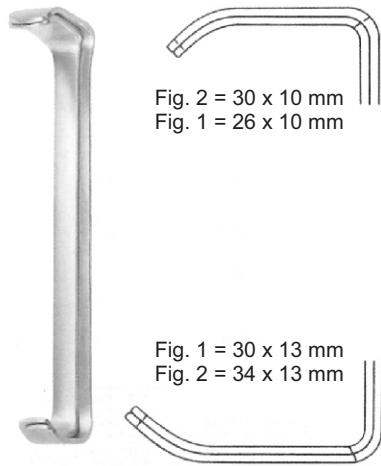

FARABEUF
 ZD-69-3001
 12 cm/4 3/4"
 Fig. 1 - 2

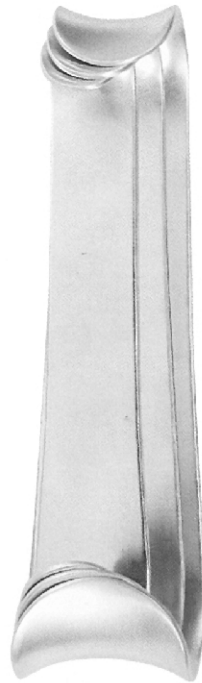

ROUX
 ZD-69-3002
 Set complete, Fig. 1- 3

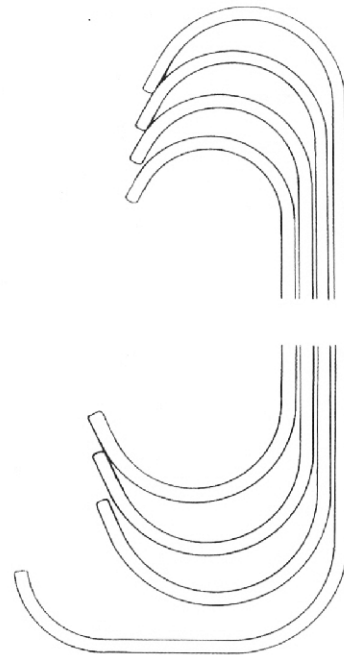
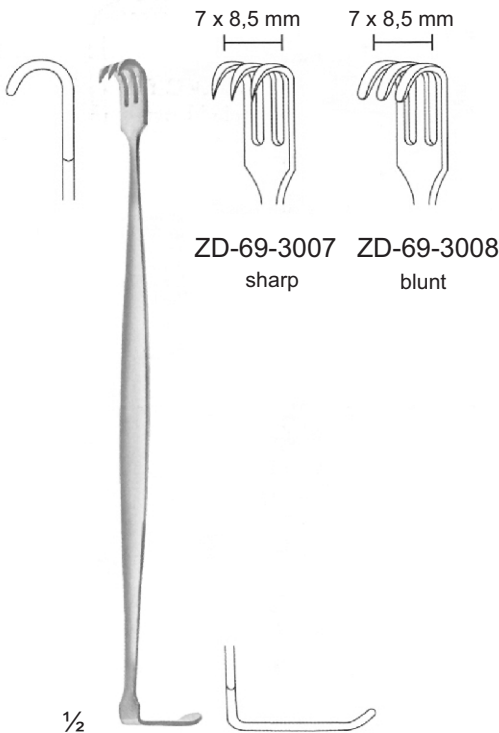
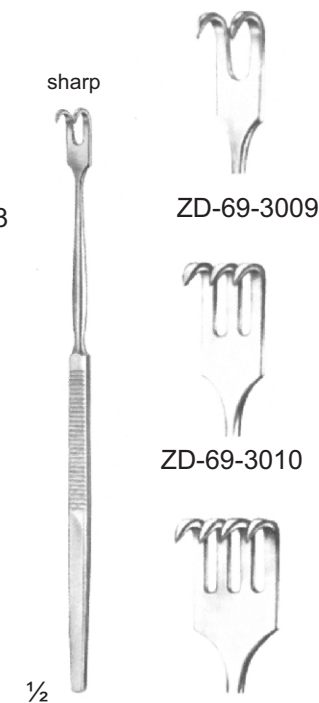

Fig. 1	14 cm/5 1/2"	ZD-69-3003	24 x 20 / 30 x 28
Fig. 2	15 cm/6"	ZD-69-3004	29 x 26 / 36 x 36
Fig. 3	17 cm/6 3/4"	ZD-69-3005	23 x 29 / 38 x 43
Fig. 4	18 cm/7"	ZD-69-3006	29 x 24 / 45 x 28



SENN
 17 cm/6 3/4"



16 cm/6 1/4" ZD-69-3011

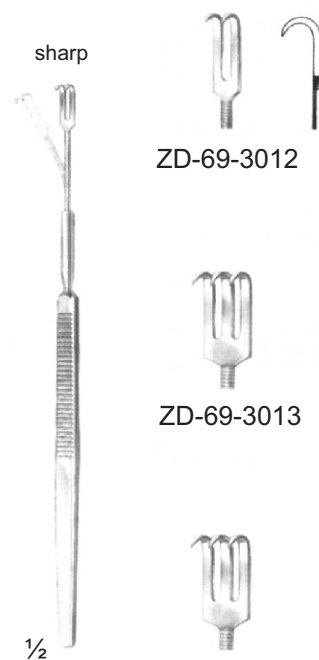

16 cm/6 1/4" ZD-69-3014

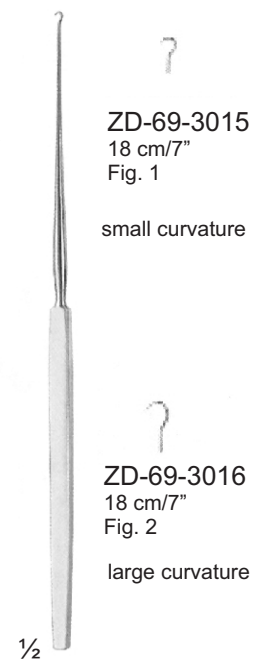

GILLIES
 18 cm/7"

RETRACTORS

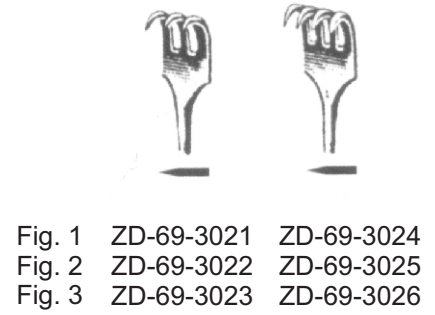
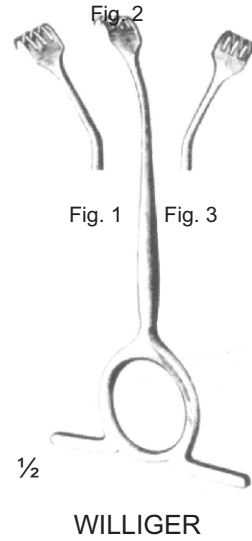
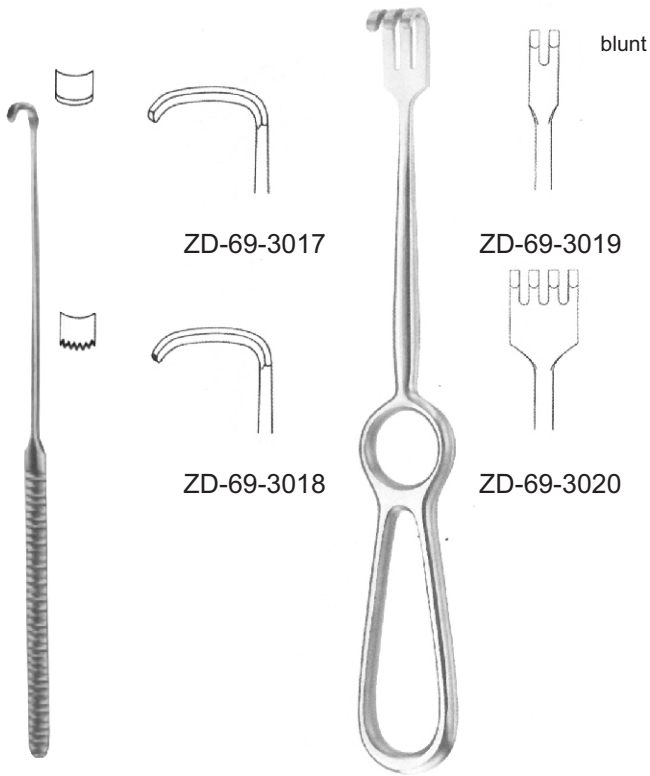

STRANDELL-STILLE
 19, cm/7 1/2"

VOLKMANN
 21,5 cm/8 1/2"

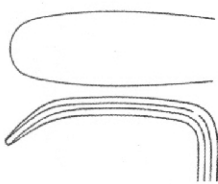

ZD-69-3027
 30x 11 mm

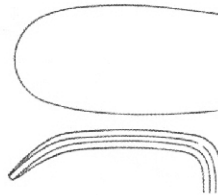

ZD-69-3029
 30x 16 mm

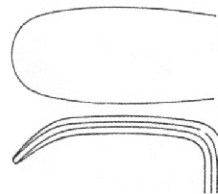

ZD-69-3028
 30x 14 mm

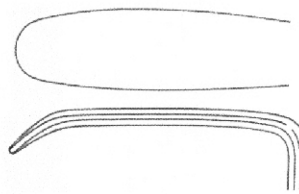

ZD-69-3030
 40x 11 mm

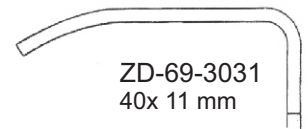

ZD-69-3031
 40x 11 mm



ZD-69-3032
 55x 11 mm

LANGENBECK
 22 cm/8 3/4"

KOCHER-LANGENBECK
 22 cm/8 1/2"

RETRACTORS



MIDDELDORPF

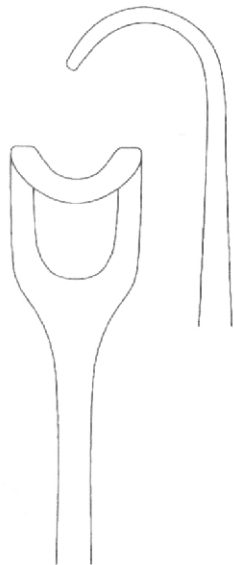

ZD-69-3033
 21,5 cm/8 1/2"
 14 x 17 mm

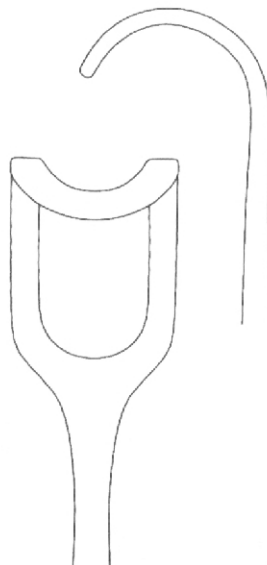

ZD-69-3034
 22 cm/8 3/4"
 20 x 22 mm



KOCHER LANGENBECK
 ZD-69-3035
 21 cm/8 1/4"
 23 x 8 mm



WARD
 ZD-69-3036
 15,5 cm/6"



BOWDLER=HENRY
 ZD-69-3037
 16 cm/6 1/4"



KAY (AUSTIN)
 ZD-69-3038

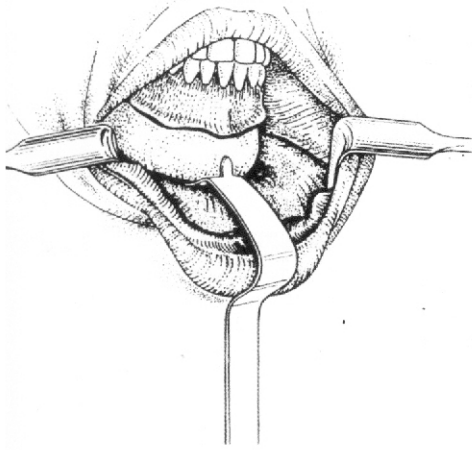

16,5 mm

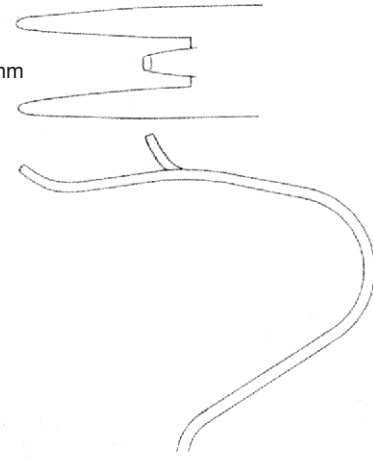

OBWEGESER
 ZD-69-3039
 16 cm/6 1/4"

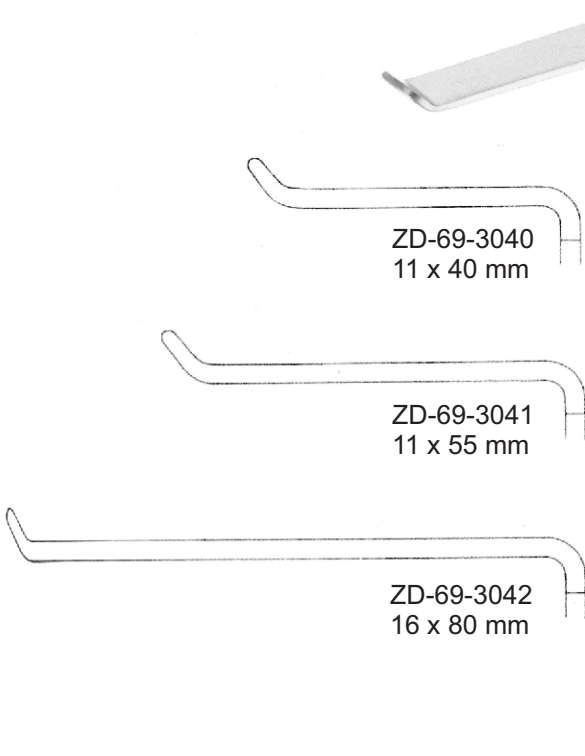

ZD-69-3040
 11 x 40 mm

ZD-69-3041
 11 x 55 mm

ZD-69-3042
 16 x 80 mm

OBWEGESER
 21,5 cm/8 1/2"

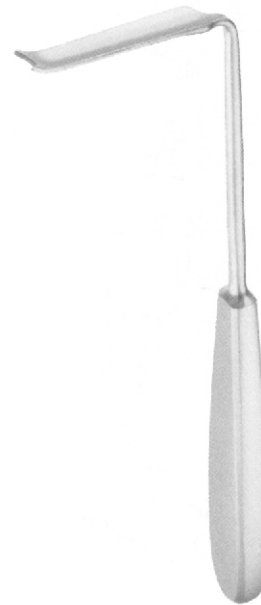

ZD-69-3043
 30 x 9/12 mm

ZD-69-3044
 45 x 9/12 mm

ZD-69-3045
 60 x 9/12 mm

OBWEGESER

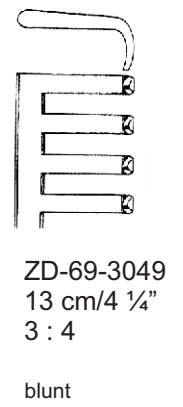
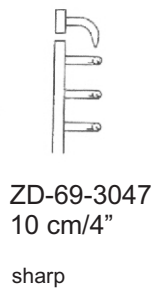
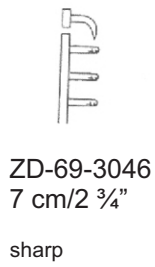
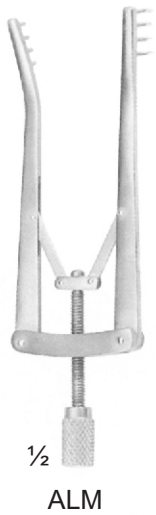

70

- EN** Mouth and Tongue
- DE** Mund und Zunge
- ES** Boca y la lengua

Page 149 to 152





DOYEN-JANSEN (MOLT)
 ZD-70-3100 9 cm/3 ½"
 ZD-70-3101 11 cm/4 ½"
 ZD-70-3102 14 cm/5 ½"



DENHARDT
 ZD-70-3103
 12 cm/5"

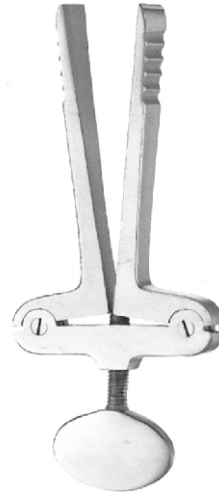

HEISTER
 ZD-70-3104
 13 cm/5 ¼"

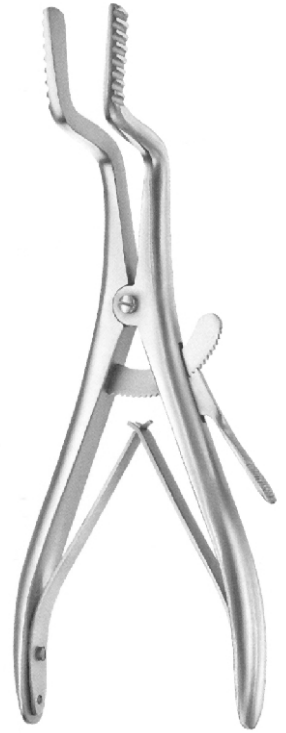

ROSIER-KOENIG
 16 cm/6 ¼" ZD-70-3105
 19 cm/7 ½" ZD-70-3106



JENNINGS
 9 cm/3 ½" ZD-70-3107
 11 cm/4 ½" ZD-70-3108
 13 cm/5" ZD-70-3109
 15 cm/6" ZD-70-3110

24 x 27 mm



COLLIN
 ZD-70-3111
 16 cm/6 ½"



YOUNG
 ZD-70-3112
 16 cm/6 ½"

ZD-70-3113

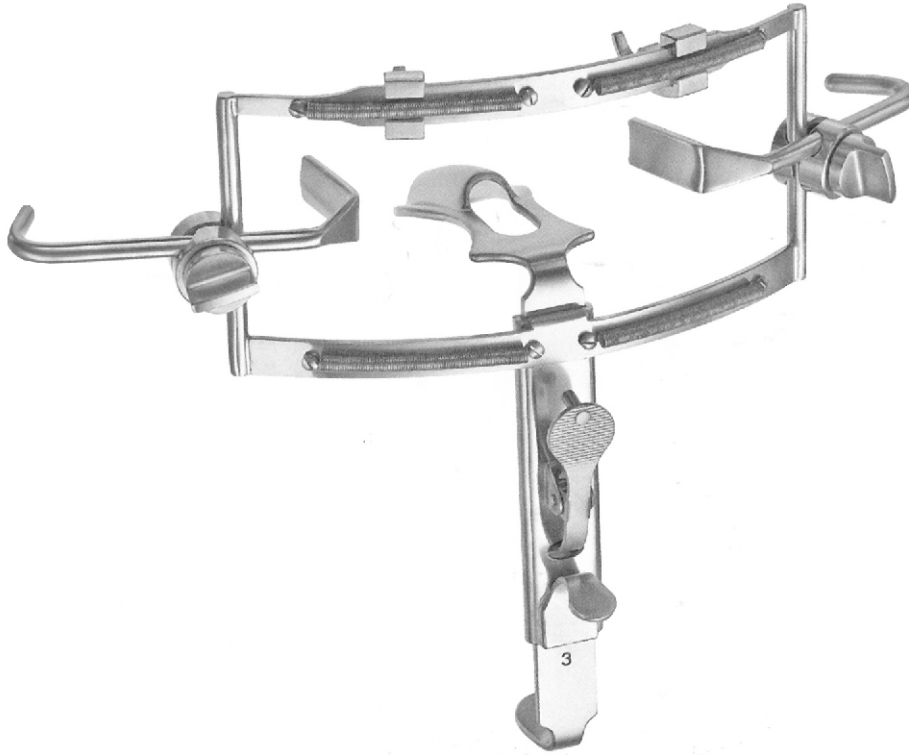

complete with frame,
 3 tongue depressors,
 2 tooth plates

DINGMANN
 ZD-70-3114
 14,5 cm/5 ¾"

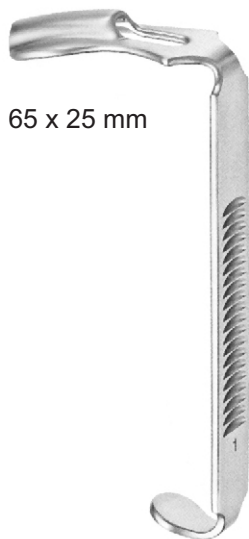

65 x 25 mm

ZD-70-3115
 13,5 cm/5 ¼"



70 x 29 mm

ZD-70-3116
 13,5 cm/5 ¼"

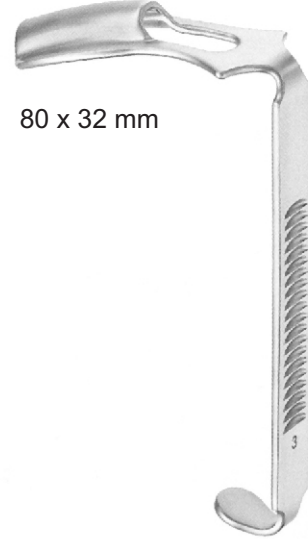

80 x 32 mm

ZD-70-3117
 13,5 cm/5 ¼"

19 / 15 mm



ZD-70-3118
16 cm/6 1/4"

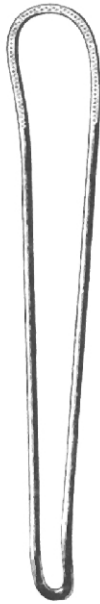

FRENZEL
ZD-70-3119
16,5 cm/6 1/2"

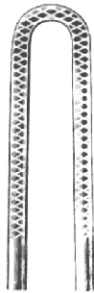

BUENING'S
ZD-70-3120
19 cm/7 1/2"



BUCHWALD
ZD-70-3121
19 cm/7 1/2"

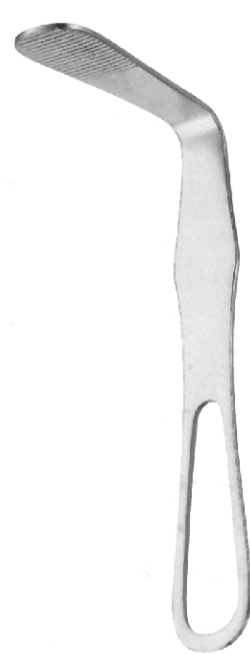

HARTMANN
ZD-70-3122
15 cm/6"

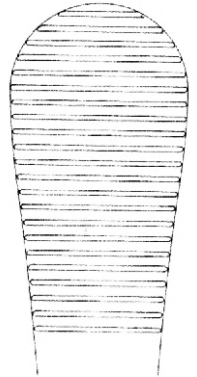

72 X 23 mm



24 / 30 mm

ZD-70-3123
13,5 cm/5 1/4"

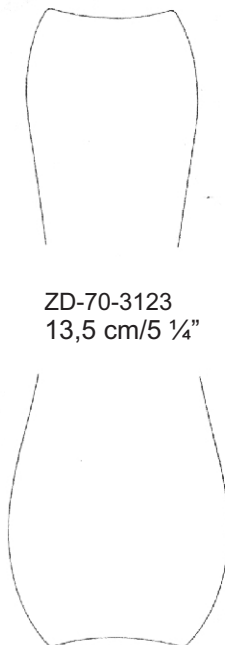

30 / 34 mm

ZD-70-3124
16 cm/6 1/4"

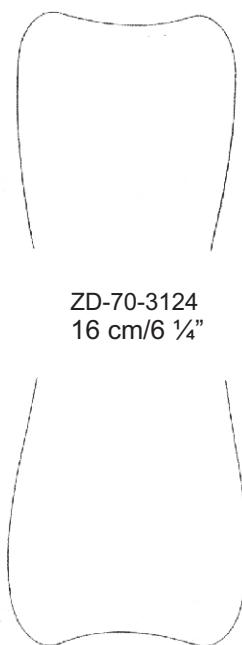

WIEDER

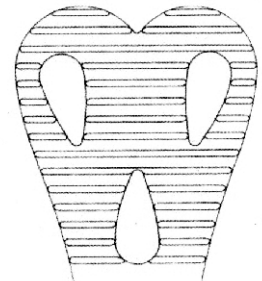

ZD-70-3125
14 cm/5 1/2"
36 mm

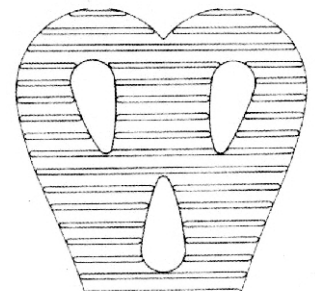

ZD-70-3126
15 cm/6"
43 mm

MOUTH GAGS



85 x 24 mm

TOBOLD
 ZD-70-3127
 14,5 cm/5 3/4"

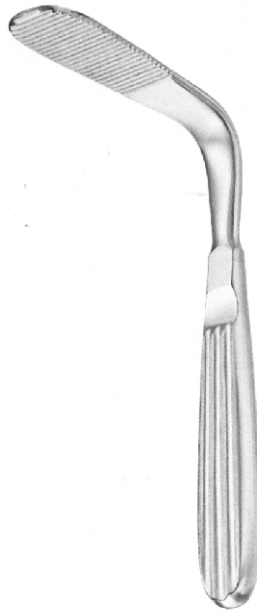

88 x 25 mm

TOBOLD
 ZD-70-3128
 15 cm/6"



STERNBERG
 ZD-70-3129
 14 cm/5 1/2"



SIMPLEX
 ZD-70-3130
 11 cm/4 1/4"

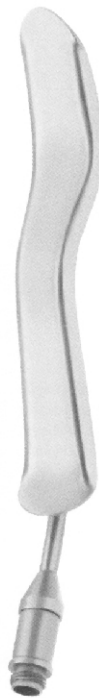

CAWOOD-MINNESOTA
 ZD-70-3131
 14 cm/5 1/2"

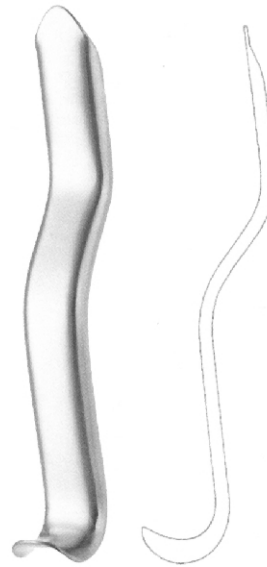

CAWOOD-MINNESOTA
 ZD-70-3132
 15 cm/6"
 20 mm



ZD-70-3133
 19 cm/7 1/2"

71

- EN** Scissors
- DE** Schere
- ES** Tijeras

Page 153 to 171

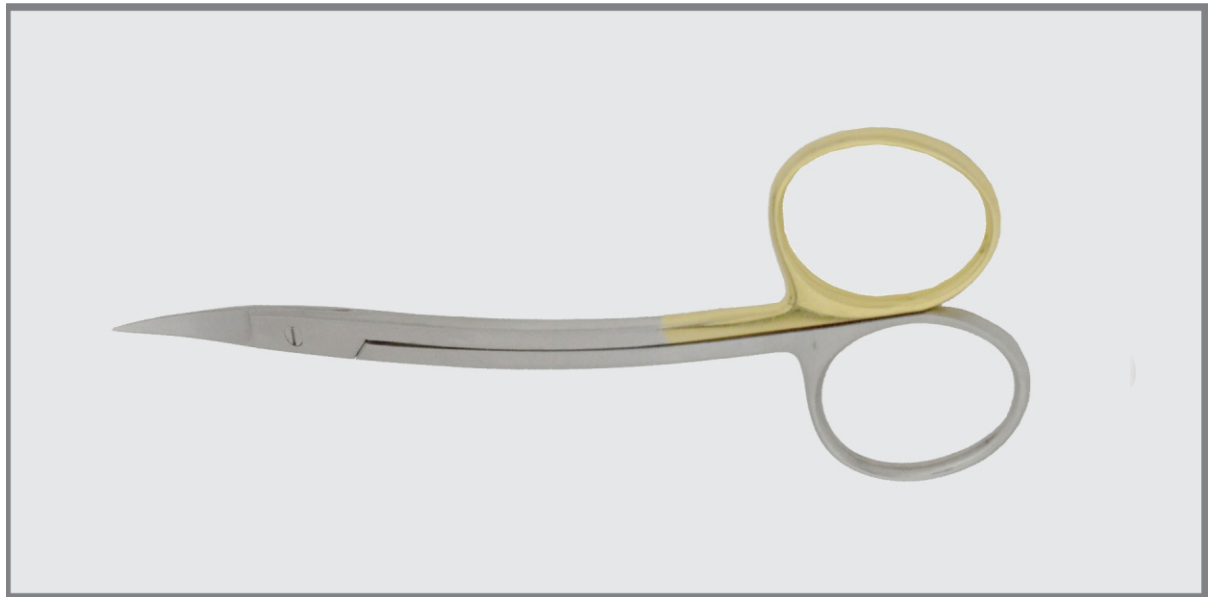



ZD-71-3200
 universal
 12 cm/4 3/4"

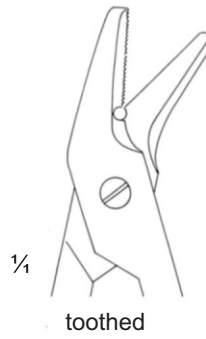

ZD-71-3201 TC
 universal
 12 cm/4 3/4"

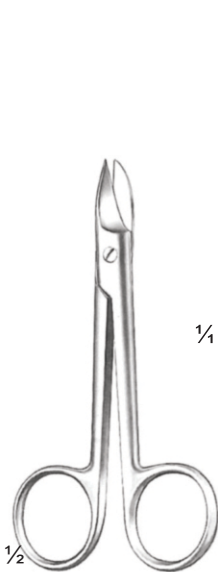

Beebee
 10.5 cm/4 1/8"



ZD-71-3202
 B-002-10 TC



ZD-71-3203
 B-003-10 TC

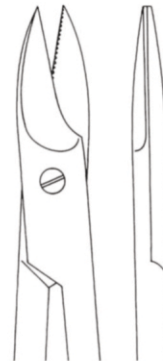

ZD-71-3204
 B-004-10 TC



ZD-71-3205
 B-005-10 TC

one toothed cutting edge



Beebee
 10.5 cm/4 1/8"



Wire Cutting Scissors ● EN
 Drahtscheren ● DE
 Tijeras para alambre ● ES

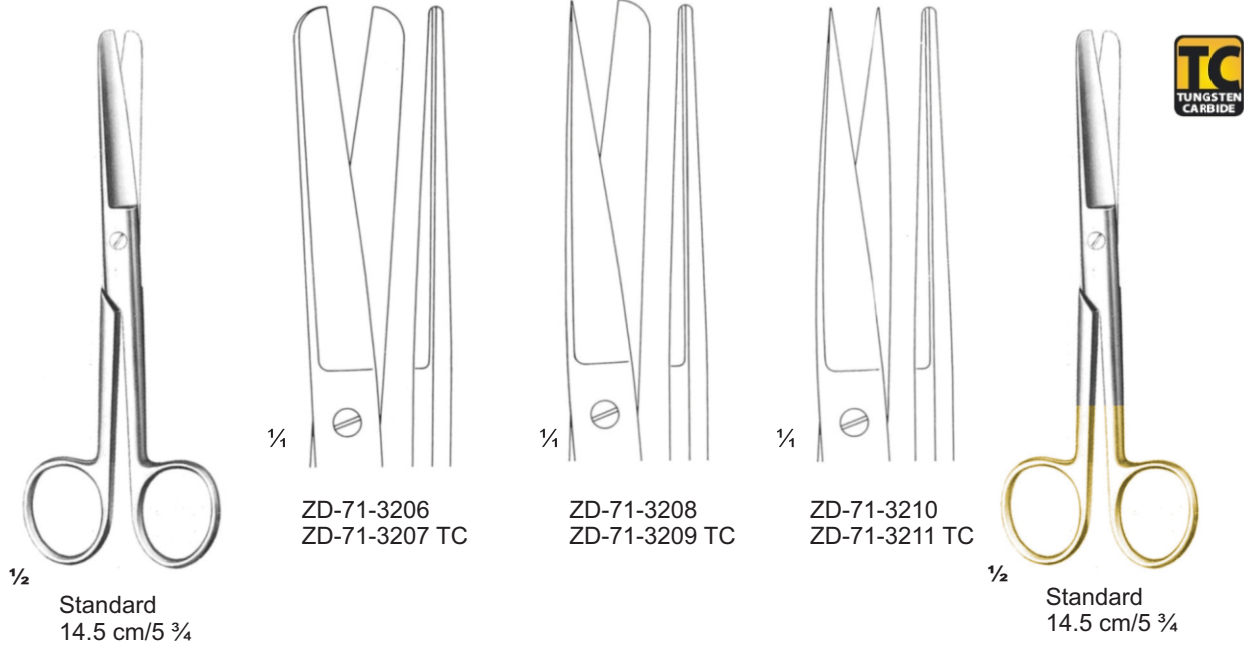



$\frac{1}{2}$ Standard
 14.5 cm/5 $\frac{3}{4}$

$\frac{1}{4}$ ZD-71-3206
 ZD-71-3207 TC

$\frac{1}{4}$ ZD-71-3208
 ZD-71-3209 TC

$\frac{1}{4}$ ZD-71-3210
 ZD-71-3211 TC

$\frac{1}{2}$ Standard
 14.5 cm/5 $\frac{3}{4}$

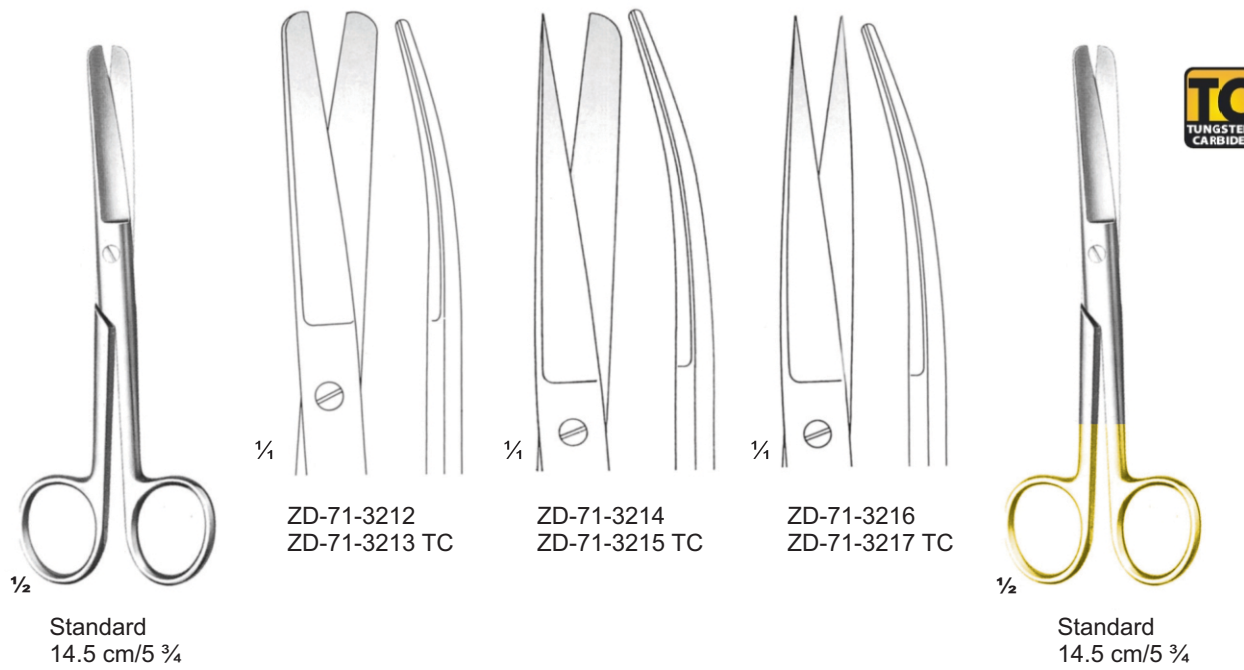



$\frac{1}{2}$ Standard
 14.5 cm/5 $\frac{3}{4}$

$\frac{1}{4}$ ZD-71-3212
 ZD-71-3213 TC

$\frac{1}{4}$ ZD-71-3214
 ZD-71-3215 TC

$\frac{1}{4}$ ZD-71-3216
 ZD-71-3217 TC

$\frac{1}{2}$ Standard
 14.5 cm/5 $\frac{3}{4}$

DELICATE

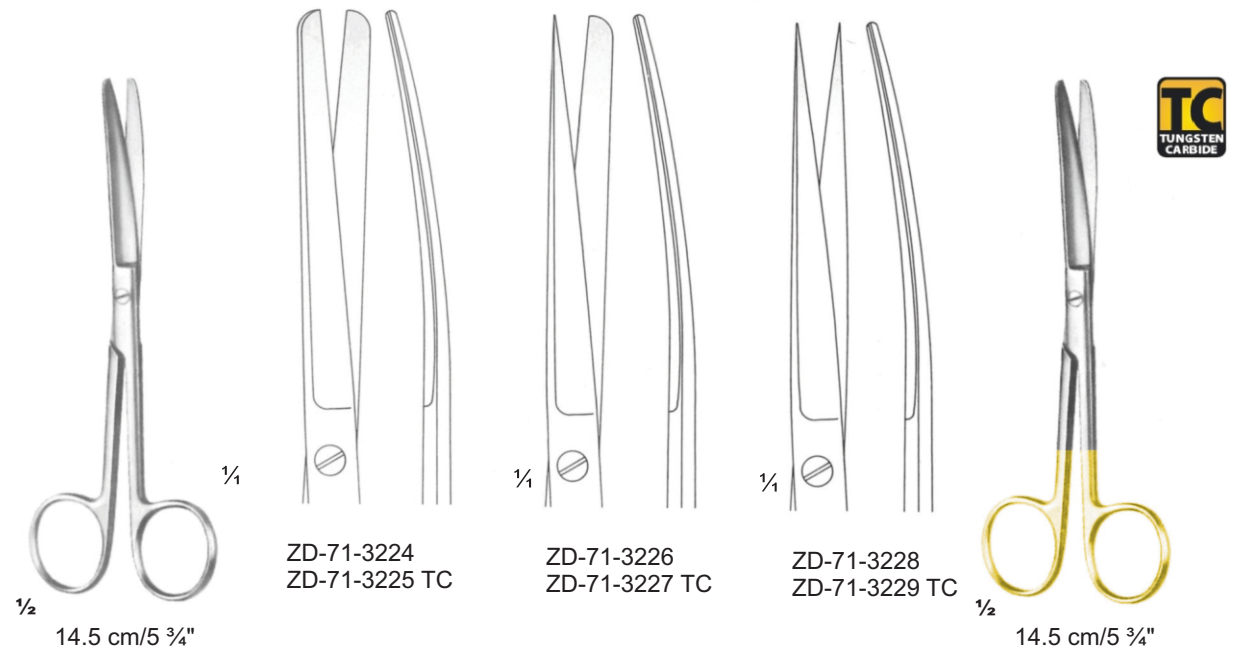
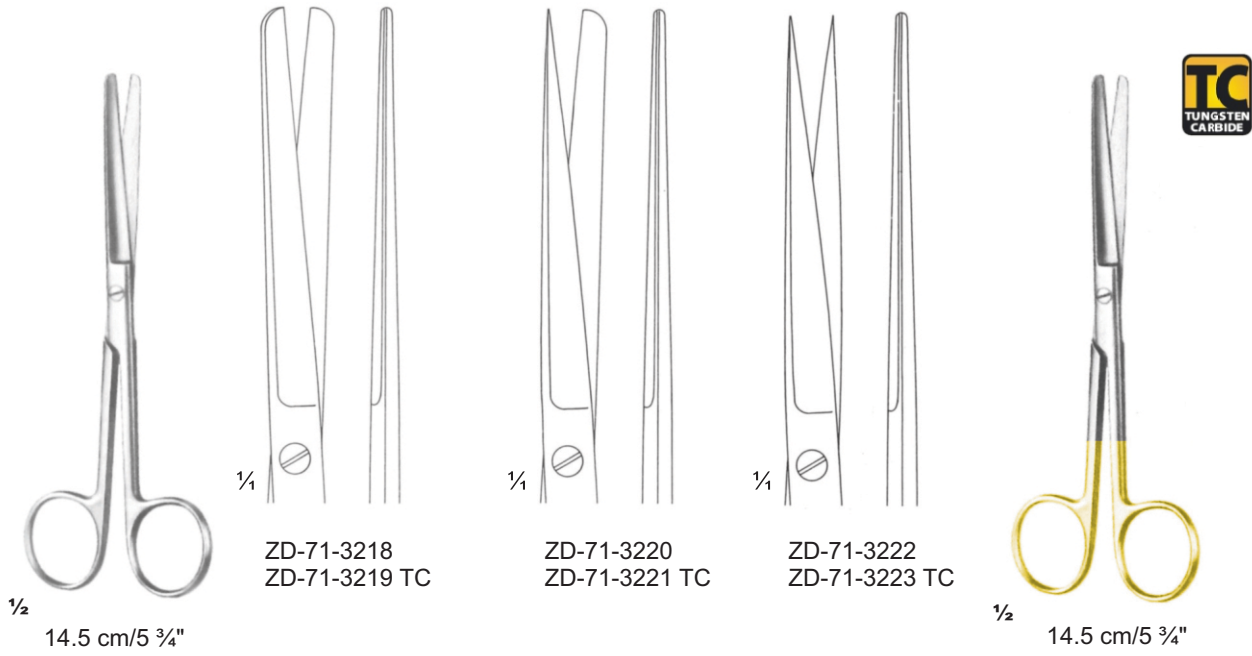

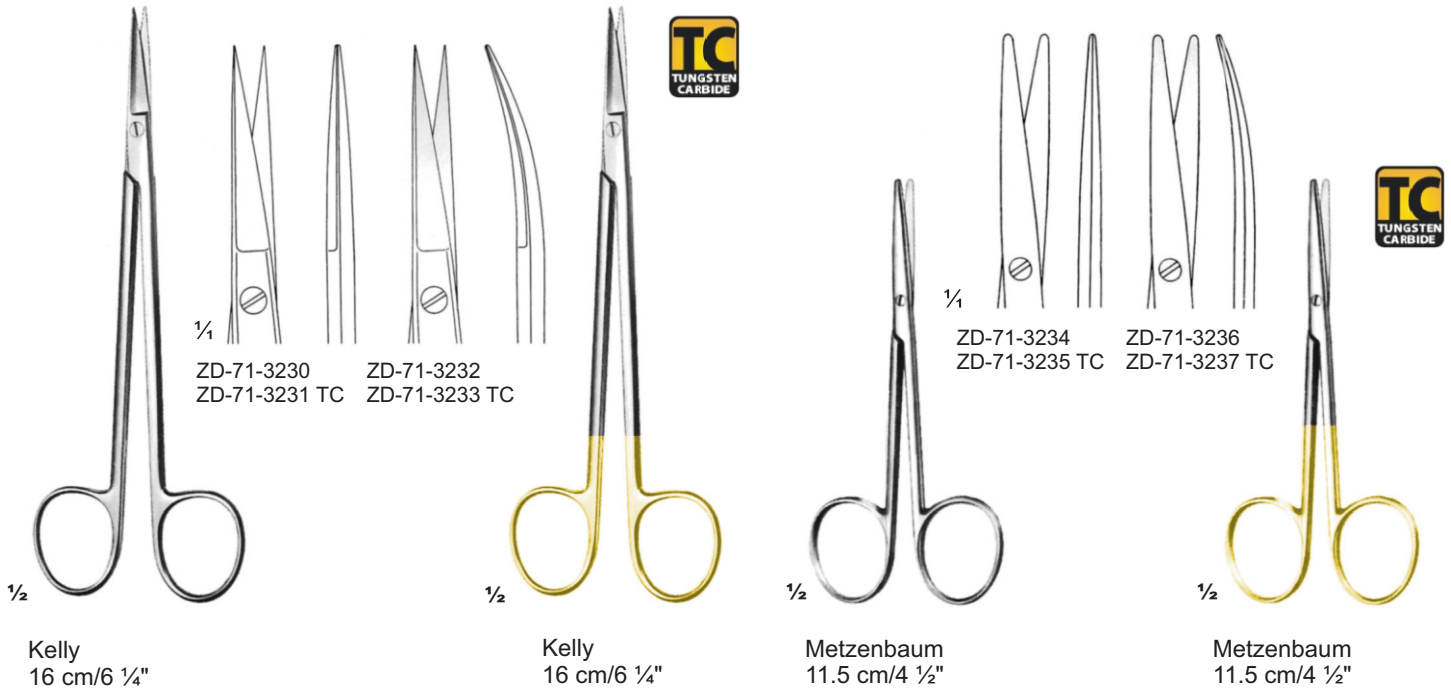

DELICATE



Metzenbaum
15.5 cm/6"

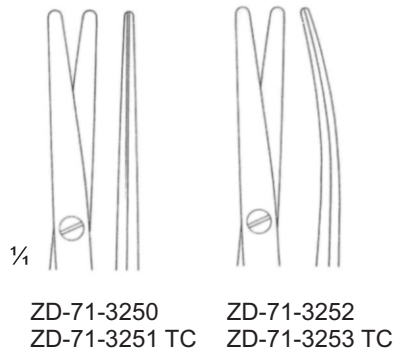

Metzenbaum
15.5 cm/6"



Metzenbaum-Nelson
18 cm/7"

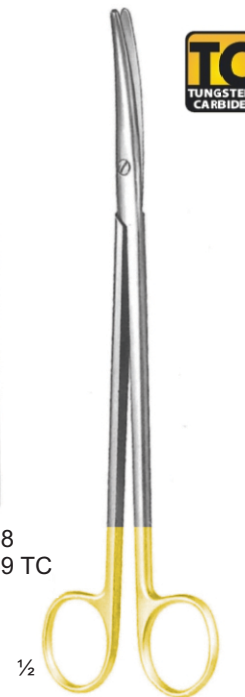
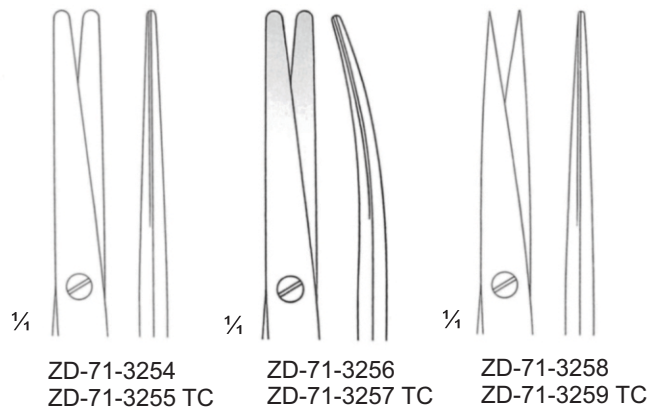

Metzenbaum-Nelson
18 cm/7"



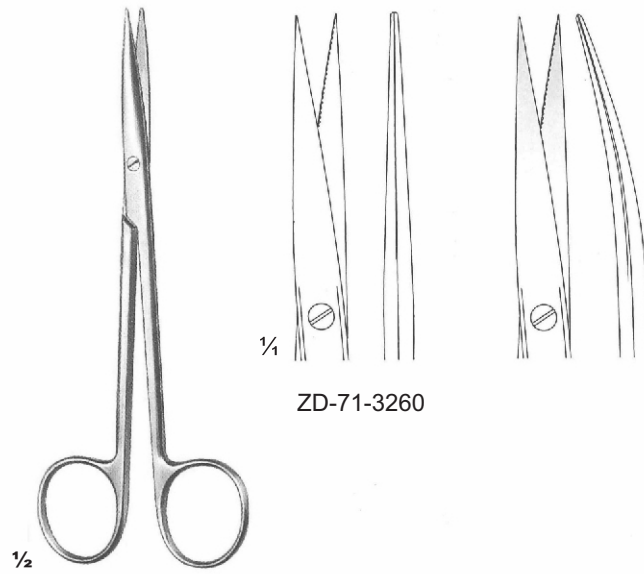

ZD-71-3260

Metzenbaum
 14.5 cm/5 3/4"

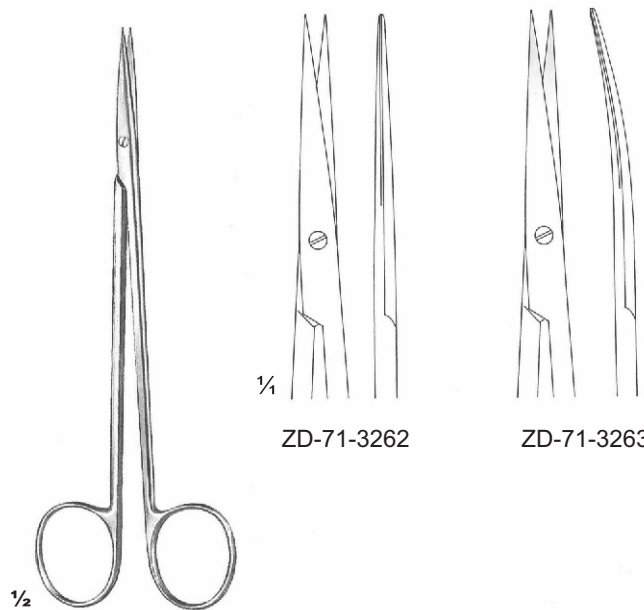

ZD-71-3262

ZD-71-3263

Nerve dissecting scissors
 15.5 cm/6"



Lexer-Fino
slender pattern
16.5 cm/6 1/2"

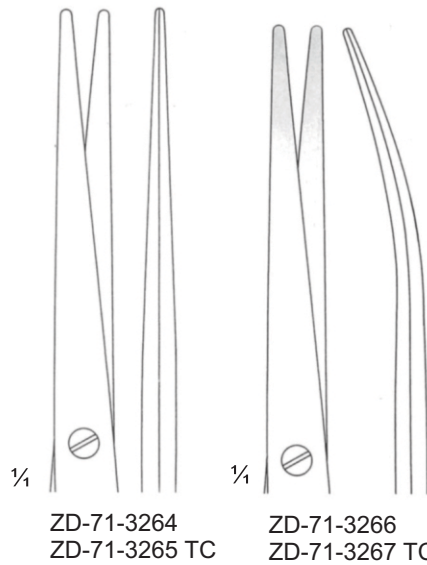

Lexer-Fino
slender pattern
16.5 cm/6 1/2"

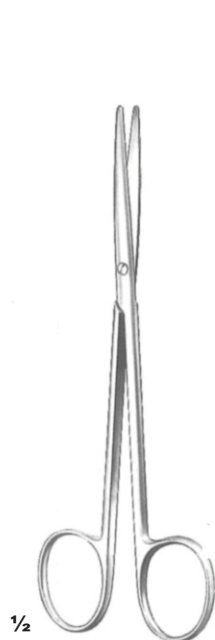

Metzenbaum-Fino
slender pattern
14.5 cm/5 3/4"

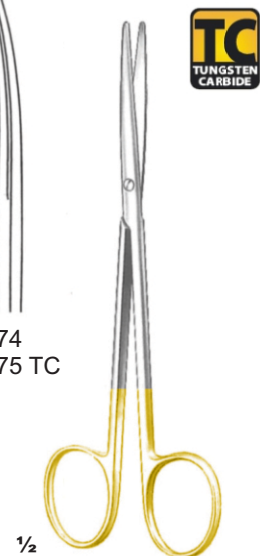
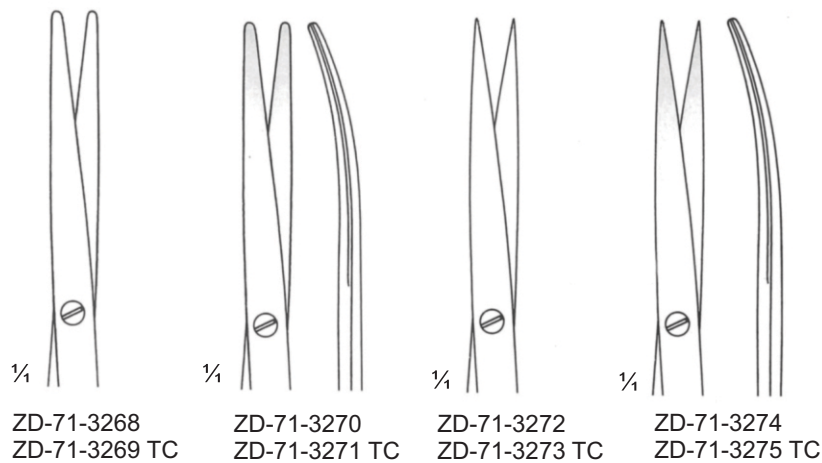

Metzenbaum-Fino
slender pattern
14.5 cm/5 3/4"



Metzenbaum-Fino
 slender pattern
 18 cm/7"



ZD-71-3276
 ZD-71-3277 TC



ZD-71-3278
 ZD-71-3279 TC



Metzenbaum-Fino
 slender pattern
 18 cm/7"



Metzenbaum-Fino
 S shaped
 18 cm/7"



ZD-71-3280
 ZD-71-3281 TC



Metzenbaum-Fino
 S shaped
 18 cm/7"



ZD-71-3282
 12.5 cm/5"



ZD-71-3283
 18 cm/7"

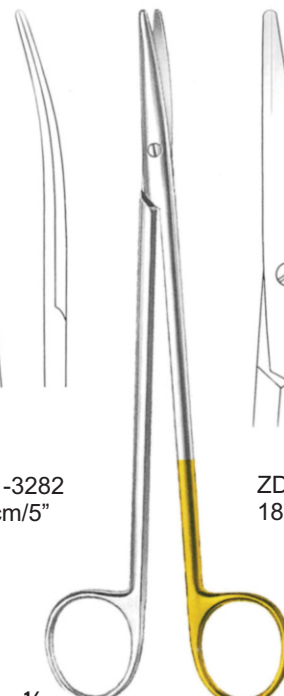

Salyer
 fine model for cleft palate



SCISSORS

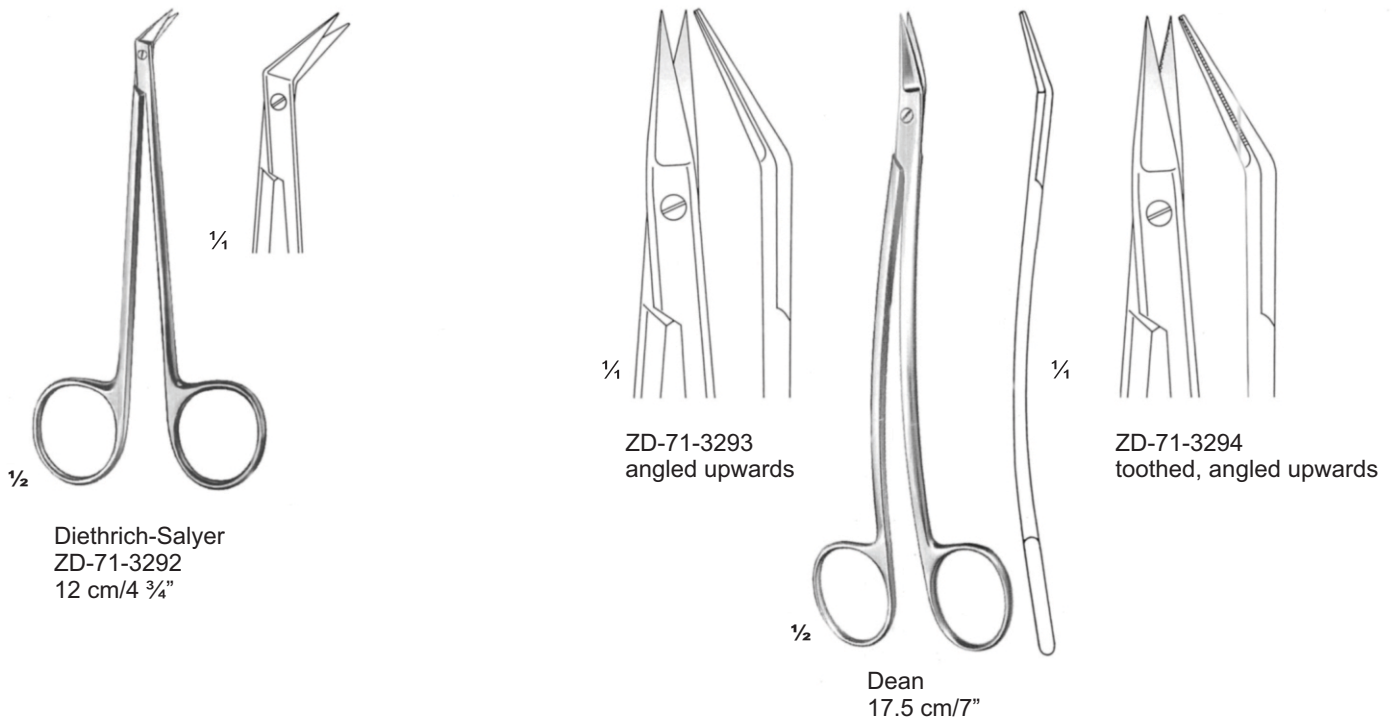

SCISSORS

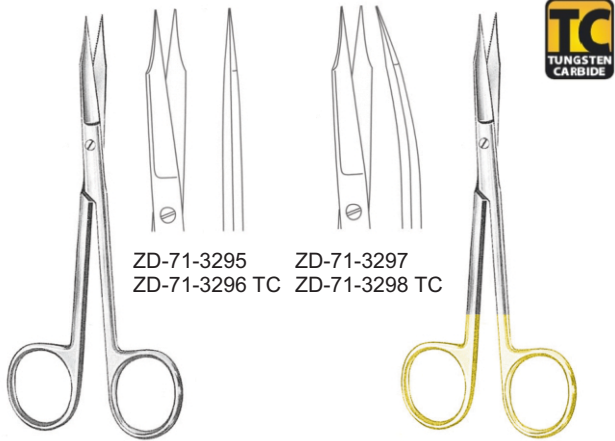

ZD-71-3295 ZD-71-3297
 ZD-71-3296 TC ZD-71-3298 TC

GOLDMANN-FOX
 13 cm/5 1/8"

GOLDMANN-FOX
 13 cm/5 1/8"

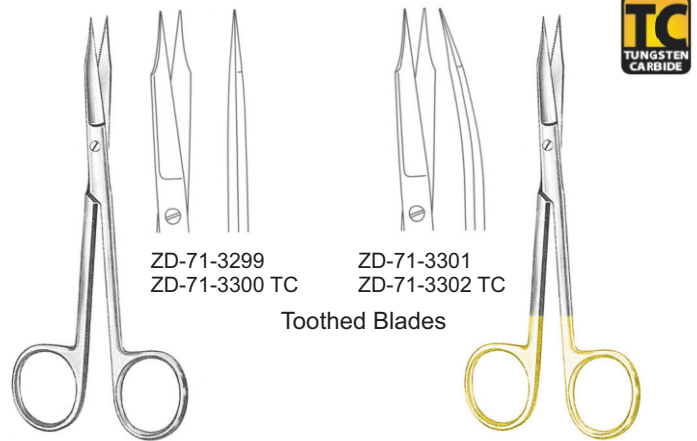

ZD-71-3299 ZD-71-3301
 ZD-71-3300 TC ZD-71-3302 TC

Toothed Blades

GOLDMANN-FOX
 13 cm/5 1/8"

GOLDMANN-FOX
 13 cm/5 1/8"

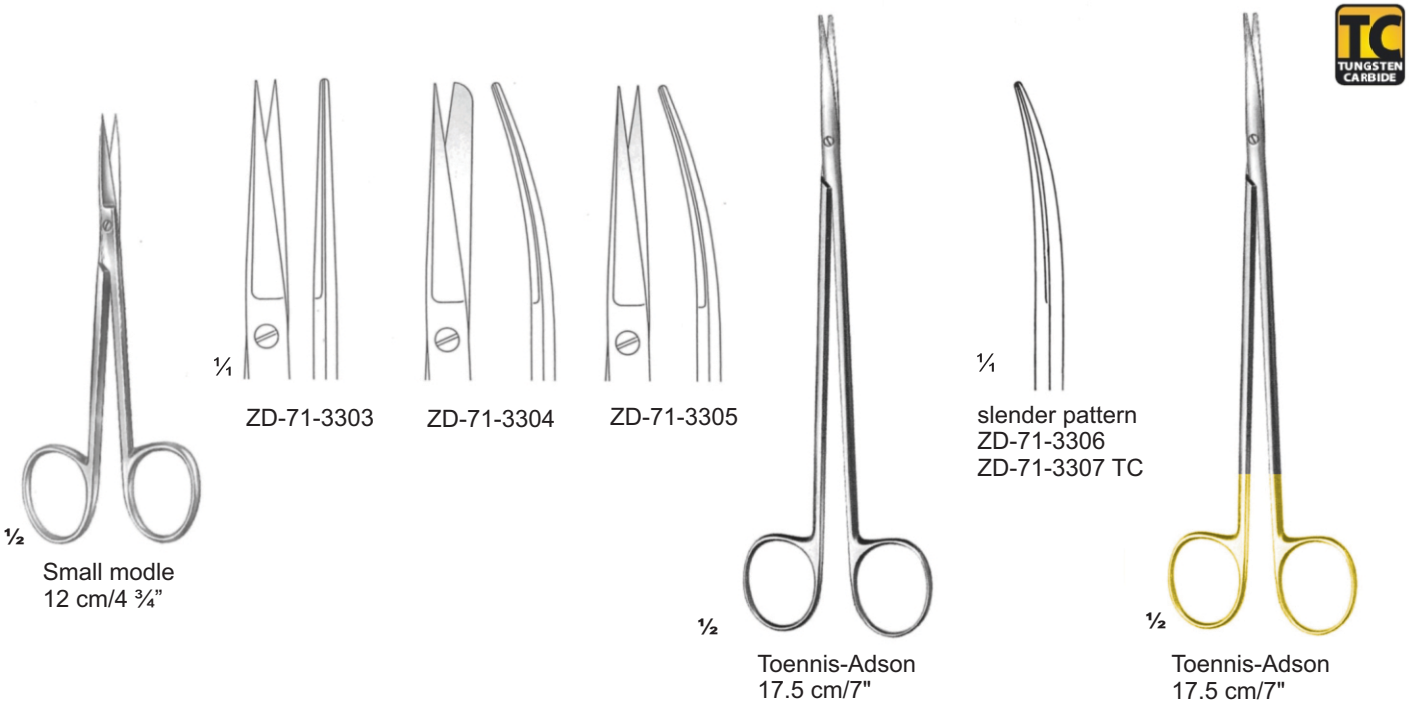

ZD-71-3303 ZD-71-3304 ZD-71-3305

slender pattern
 ZD-71-3306
 ZD-71-3307 TC

1/2
 Small modle
 12 cm/4 3/4"

1/2
 Toennis-Adson
 17.5 cm/7"

1/2
 Toennis-Adson
 17.5 cm/7"

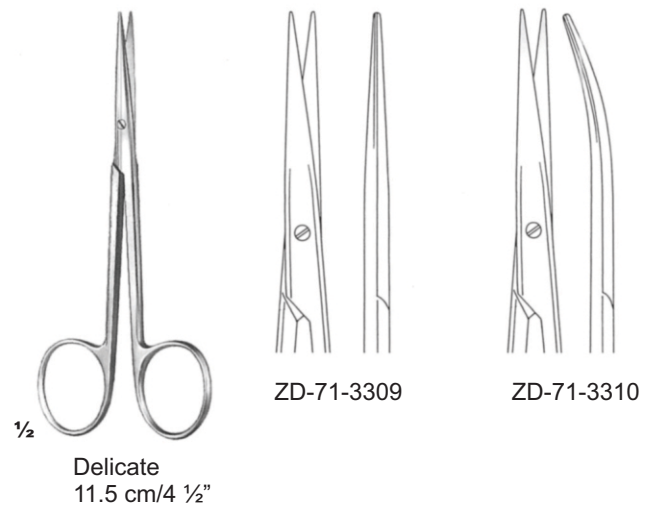

one toothed cutting edge

one toothed cutting edge

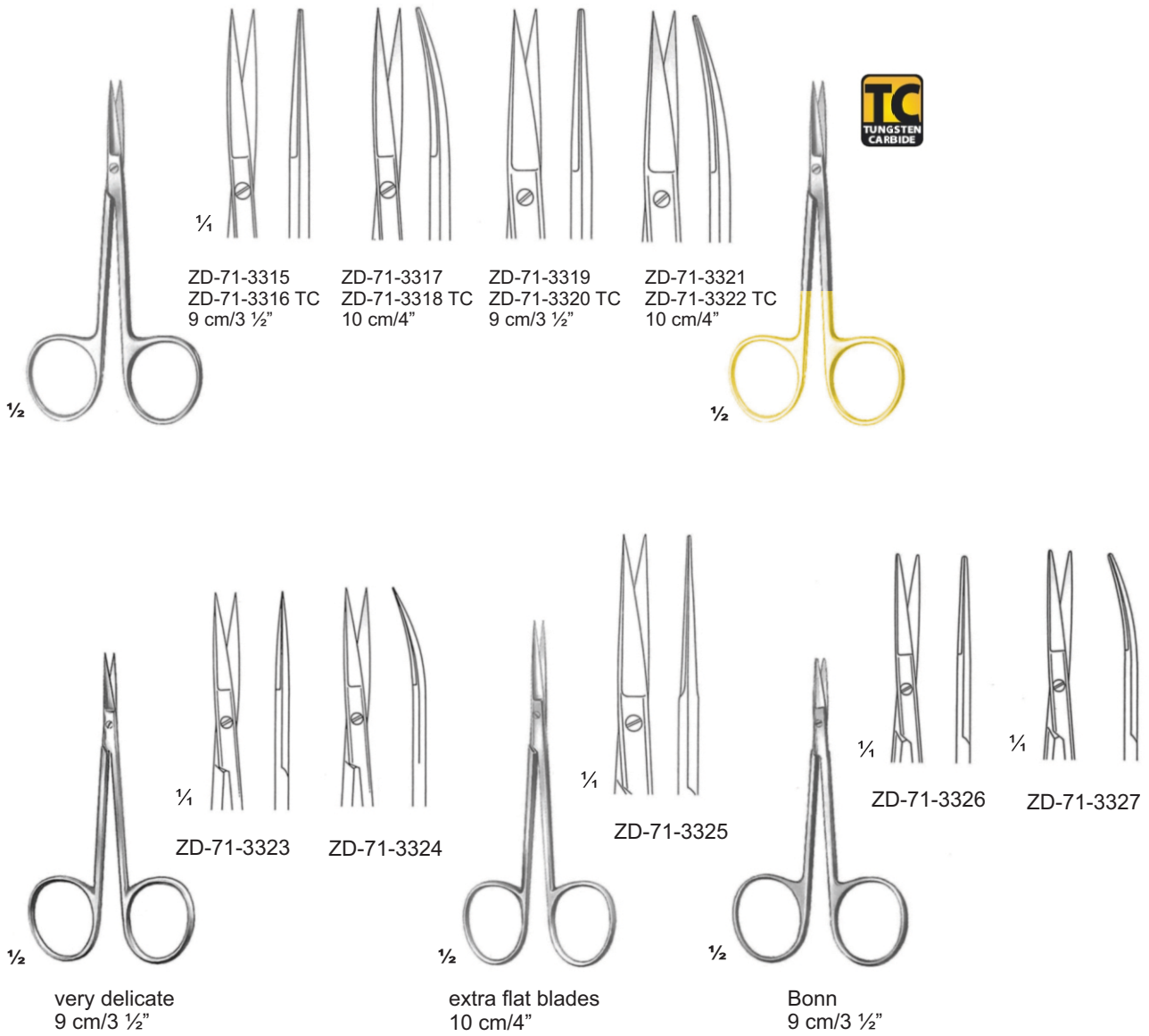

SCISSORS

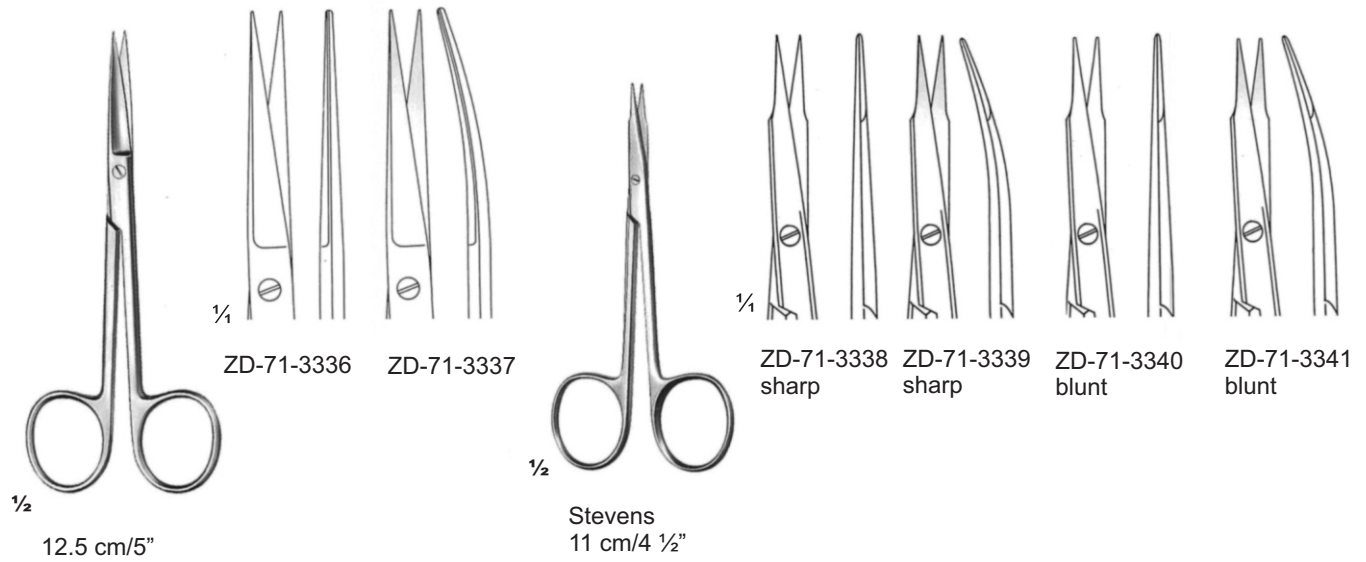
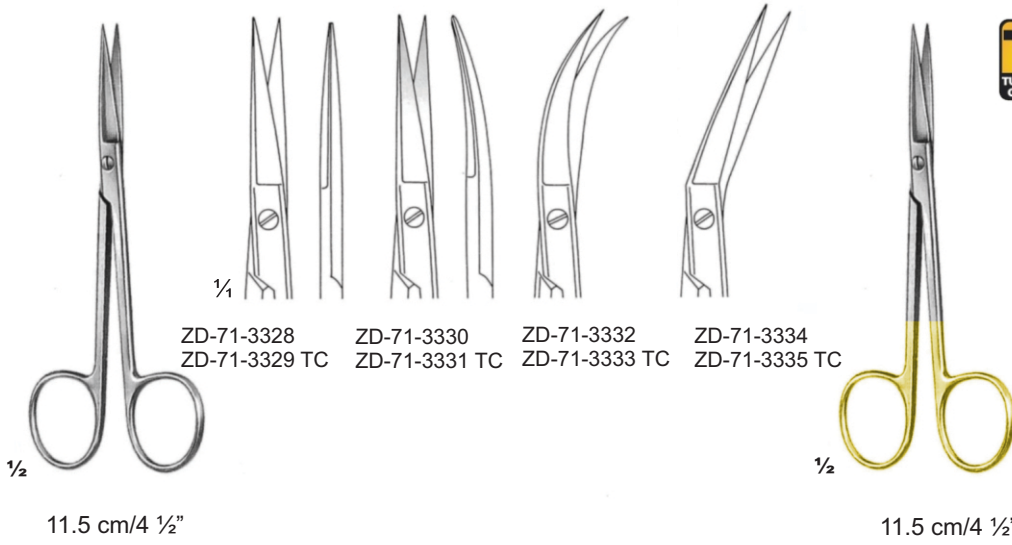

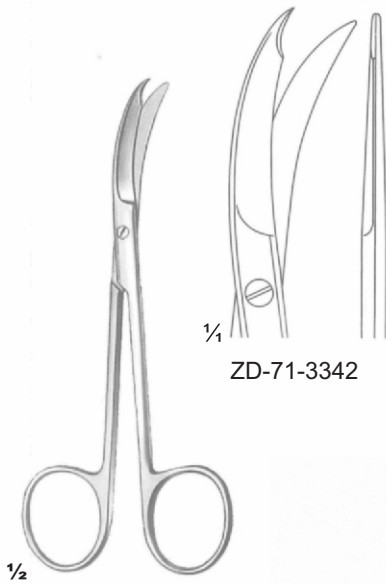

ZD-71-3342

Northbent
13 cm/5"



ZD-71-3343
9 cm/3 1/2"

Spencer



ZD-71-3344
13 cm/5"

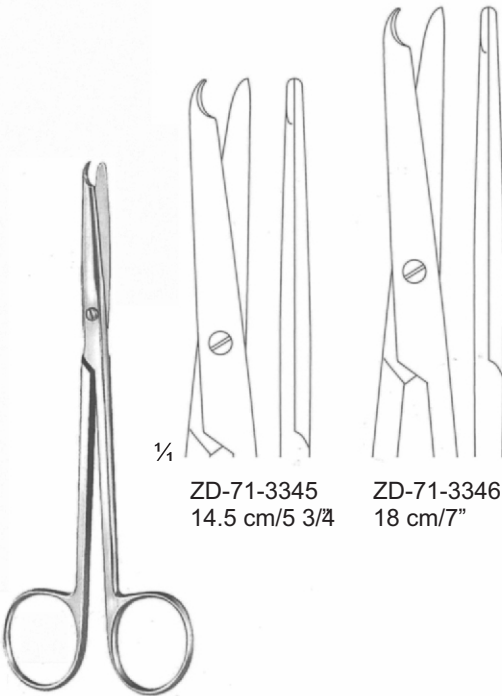

ZD-71-3345
14.5 cm/5 3/4"

Buck



ZD-71-3346
18 cm/7"

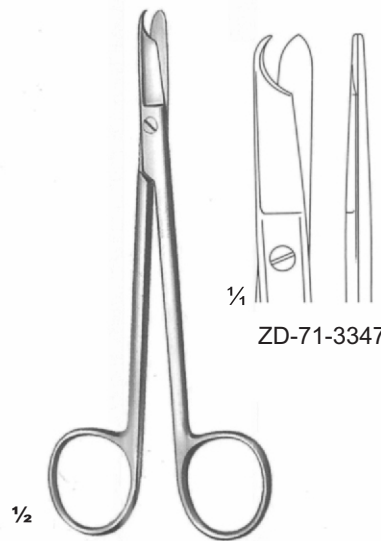

ZD-71-3347

Littauer
14 cm/5 1/2"

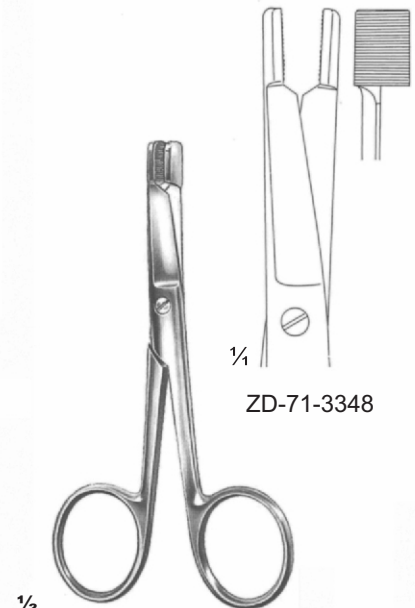

ZD-71-3348

Eiselsberg
12 cm/4 3/4"

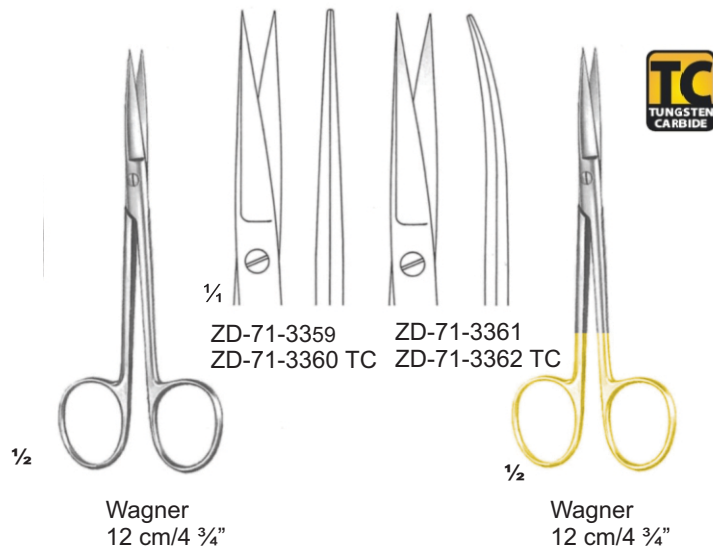
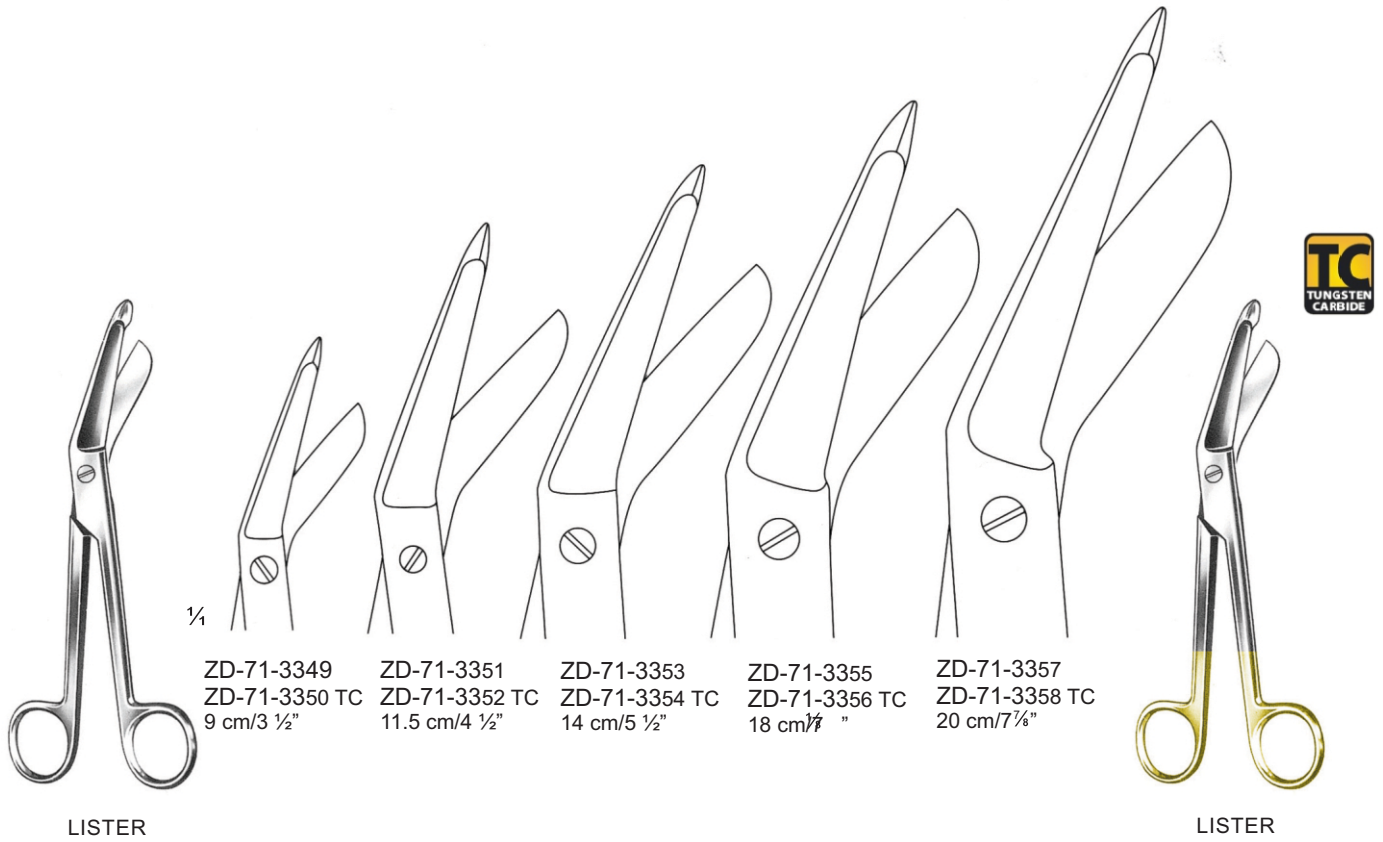

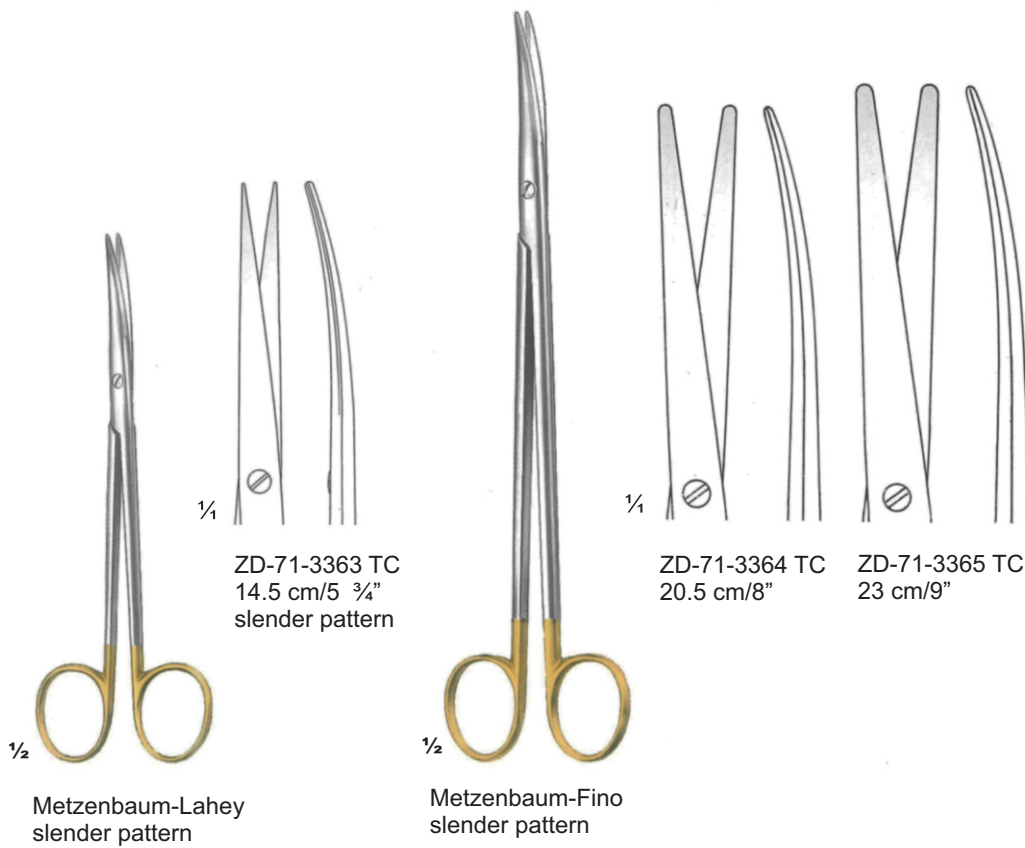

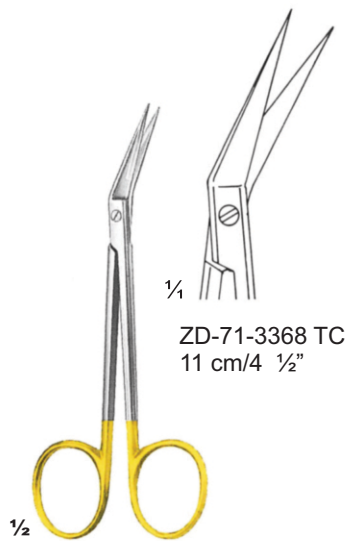
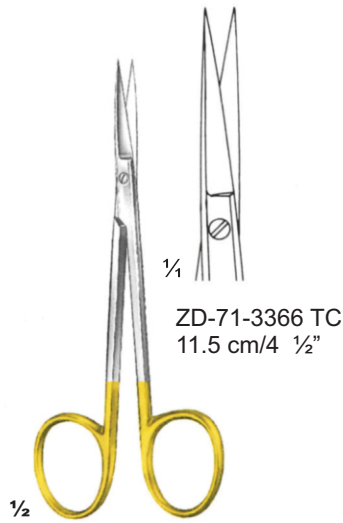

Ragnell

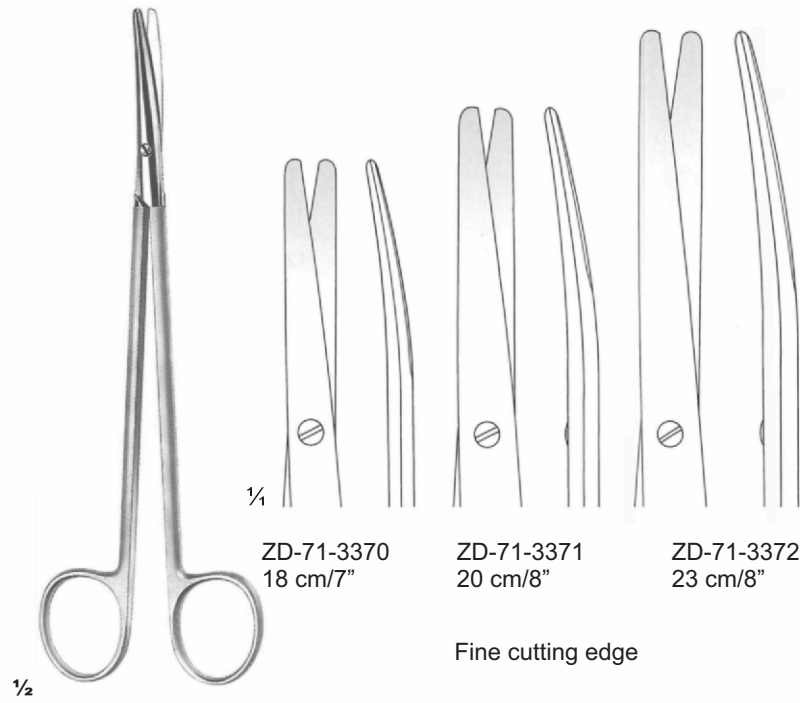

Fine cutting edge

Metzenbaum

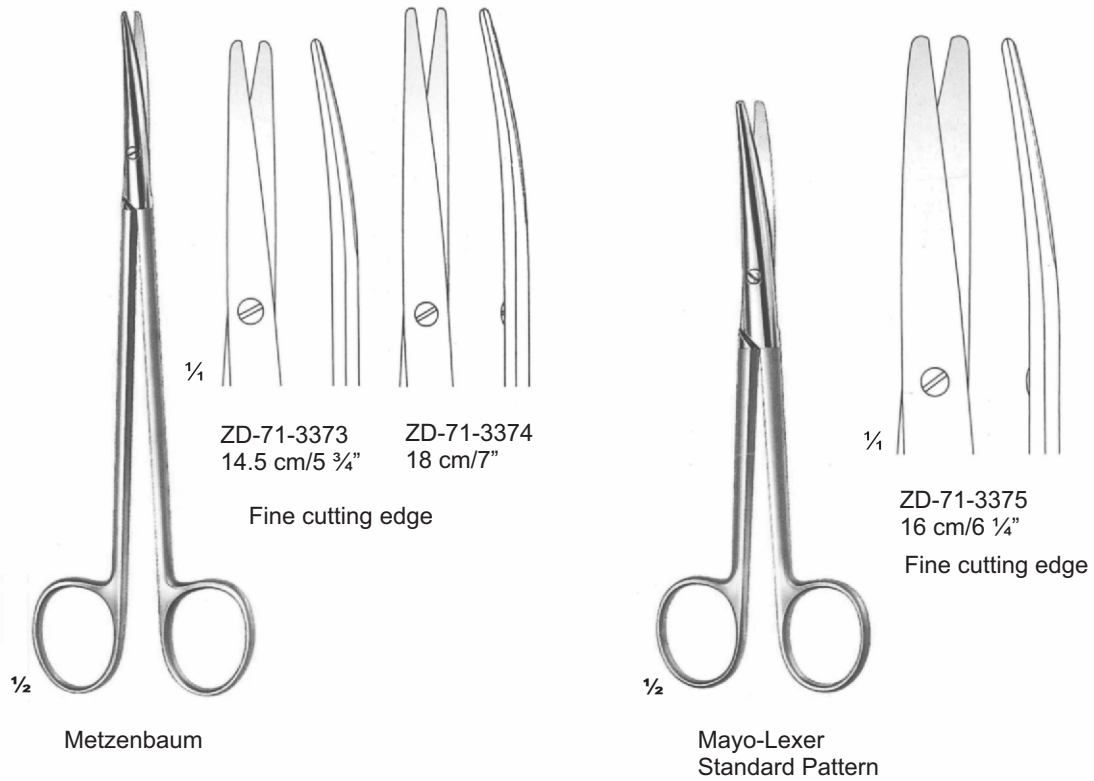

Fine cutting edge

Fine cutting edge

Metzenbaum

Mayo-Lexer
Standard Pattern

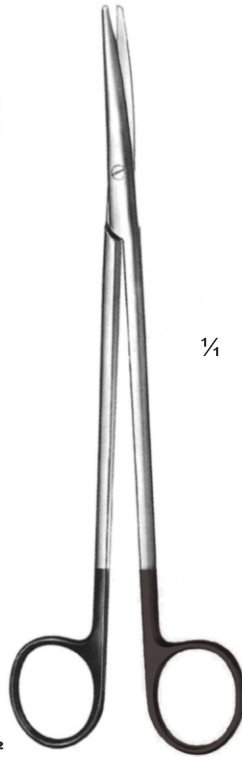

¼



ZD-71-3376 TCS
14.5 cm/5 ¾"



ZD-71-3377 TCS
18 cm/7"

For synthetic suture material
One toothed cutting edge

½



¼



ZD-71-3378 TCS
14.5 cm/5 ¾"



ZD-71-3379 TCS
17 cm/6 ¾"

For synthetic suture material
One toothed cutting edge

½

72

- EN** Micro Scissors
- DE** Mikroschere
- ES** Micro tijeras

Page 172 to 173

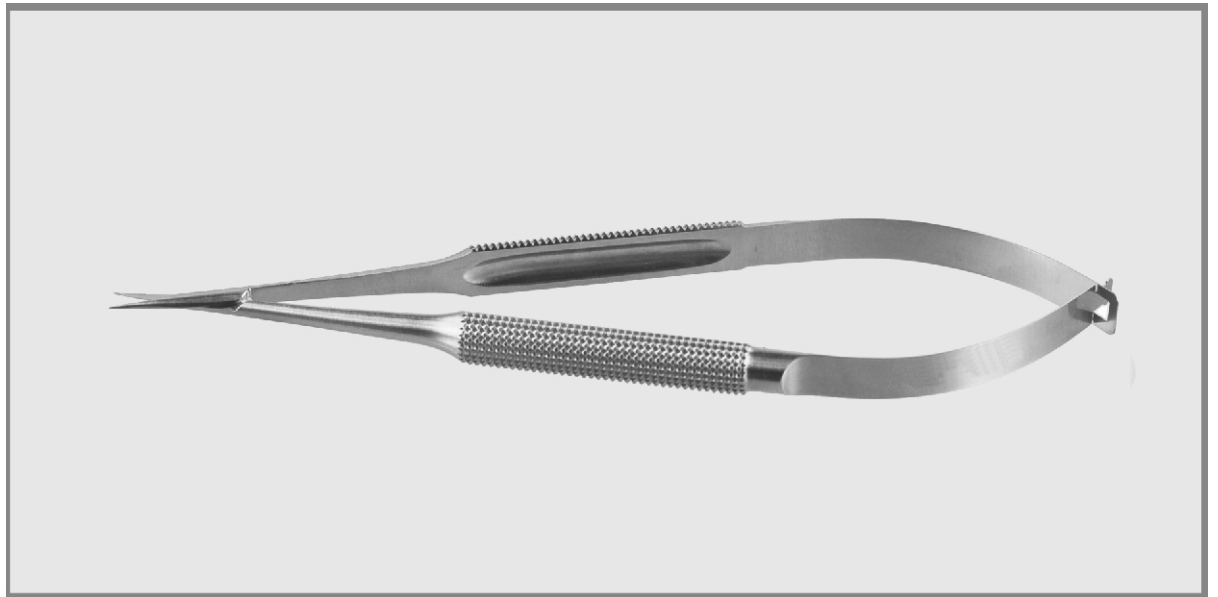

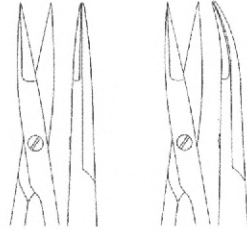

15 cm/6"	ZD-72-3401	ZD-72-3405
18 cm/7"	ZD-72-3402	ZD-72-3406
21 cm/8 ¼"	ZD-72-3403	ZD-72-3407
23 cm/9"	ZD-72-3404	ZD-72-3408



Streamlined

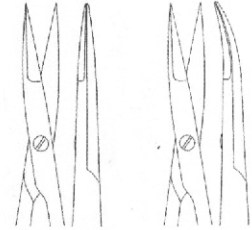
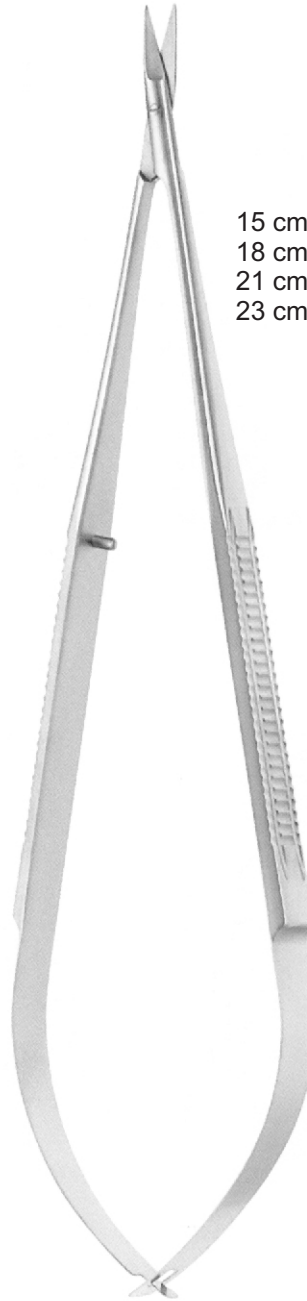

15 cm/6"	ZD-72-3409	ZD-72-3413
18 cm/7"	ZD-72-3410	ZD-72-3414
21 cm/8 ¼"	ZD-72-3411	ZD-72-3415
23 cm/9"	ZD-72-3412	ZD-72-3416



Streamlined



NOYES
ZD-72-3417
13 cm/5"

73

- EN** Orthodontics
- DE** Kieferorthopädie
- ES** Ortodoncia

Page 174 to 190

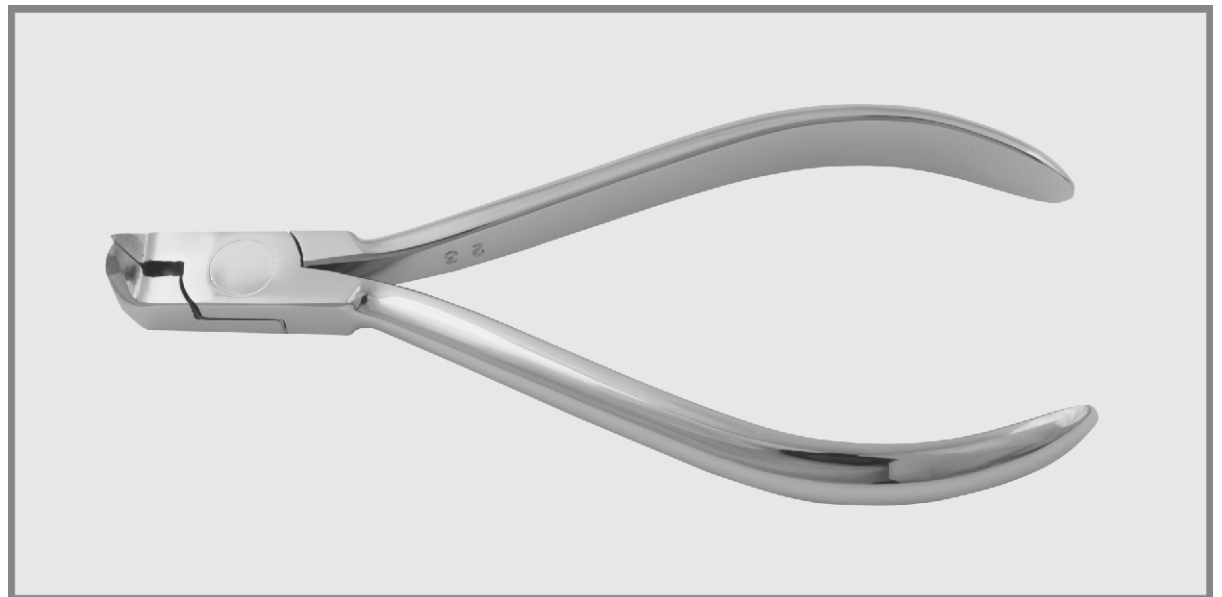

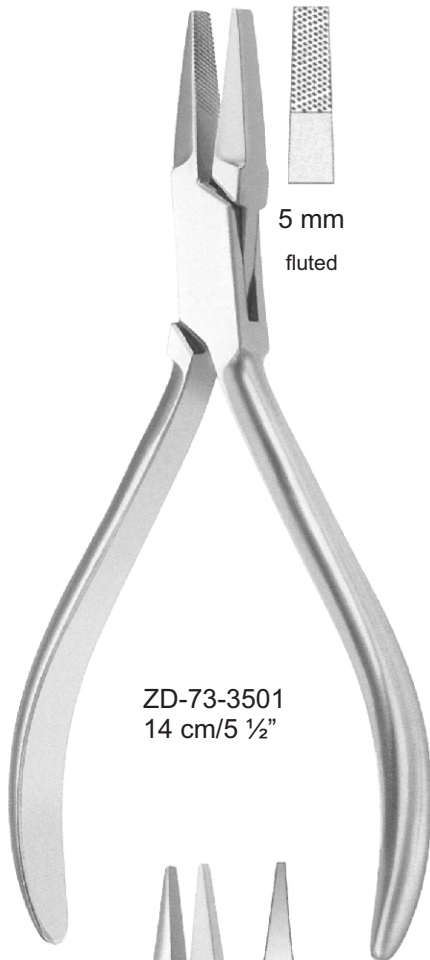

ZD-73-3501
14 cm/5 1/2"



LANGENBECK
ZD-73-3502
15 cm/6"



ZD-73-3503
14 cm/5 1/2"



ZD-73-3504
12,5 cm/4 3/4"



ZD-73-3505
13 cm/5"



ZD-73-3506
14 cm/5 1/2"

ORTHODONTICS



Contouring pliers

GOSLEE
 ZD-73-3507
 14 cm/5 1/2"



Contouring pliers

GOSLEE
 ZD-73-3508
 14 cm/5 1/2"



Contouring pliers

GOSLEE
 ZD-73-3509
 14 cm/5 1/2"



serrated

ZD-73-3510
 12,5 cm/4 3/4"



round

Flat

ZD-73-3511
 15 cm/6"



round
 nose pliers

ZD-73-3512
 13 cm/5"



ZD-73-3513
13 cm/5"



ZD-73-3514
13 cm/5"



LANGENBECK
ZD-73-3515
14 cm/5 1/2"



DUMONT
ZD-73-3516
11,5 cm/4 1/2"



DUMONT
ZD-73-3517
11,5 cm/4 1/2"



DUMONT
ZD-73-3518
11,5 cm/4 1/2"

Wire cutter, front action



ZD-73-3519
 11 cm/4 1/4"



ZD-73-3520
 11,5 cm/4 1/2"



ZD-73-3521
 12,5 cm/4 3/4"



ZD-73-3522
 11,5 cm/4 1/2"



ZD-73-3523
 11,5 cm/4 1/2"

0,7 mmØ
 for hard wire up to



1,0 mm Ø
 for hard wire up to

ZD-73-3524
 15 cm/6"



SCHWARZ
 ZD-73-3525
 13 cm/5"
 Modell I



SCHWARZ
 ZD-73-3526
 13 cm/5"
 Modell II



SCHWARZ
 ZD-73-3527
 13 cm/5"
 Modell III



SCHWARZ
 ZD-73-3528
 14,5 cm/5 ¾"



FISCHER
 ZD-73-3529
 14 cm/5 ½"

ORTHODONTICS



ANDRESEN
 ZD-73-3530
 13,5 cm/5 1/2"



STADLER
 ZD-73-3533
 15 cm/6"



sling forming pliers

McKELLOPS
 ZD-73-3531
 17 cm/6 3/4"

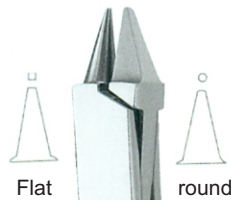

ANGLE
 ZD-73-3534
 12,5 cm/5"



McKELLOPS-STADLER
 ZD-73-3532
 16 cm/6 1/4"

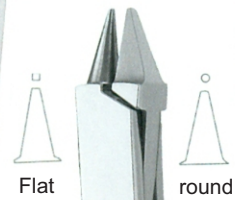

ANGLE
 ZD-73-3535
 12,5 cm/5"



ADAMS
 ZD-73-3536
 13 cm/5"



YOUNG
 ZD-73-3537
 13 cm/5"



TWEED
 ZD-73-3538
 13,5 cm/5 1/2"



TWEED
 ZD-73-3539
 13,5 cm/5 1/2"



DE LA ROSA
 ZD-73-3540
 12,5 cm/5"

Contouring pliers



DE LA ROSA
 ZD-73-3541
 12,5 cm/5"

ORTHODONTICS

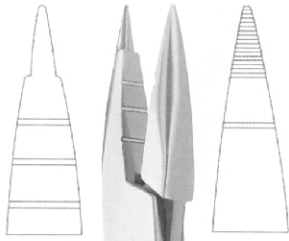

JARABAK
 ZD-73-3542
 14 cm/5 1/2"

ovalen Draht bis
 hart 1,5 x 0,75 mm

oval wire up to
 1.5 x 0.75 mm



0,7 mm Ø
 hard wire up to



ADERER
 ZD-73-3543
 14 cm/5 1/2"

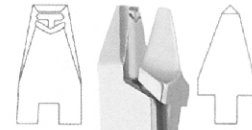

KOEHLER
 ZD-73-3544
 12 cm/4 3/4"



ZD-73-3545
 14 cm/5 1/2"

0,7 mm Ø
 for hard wire up to

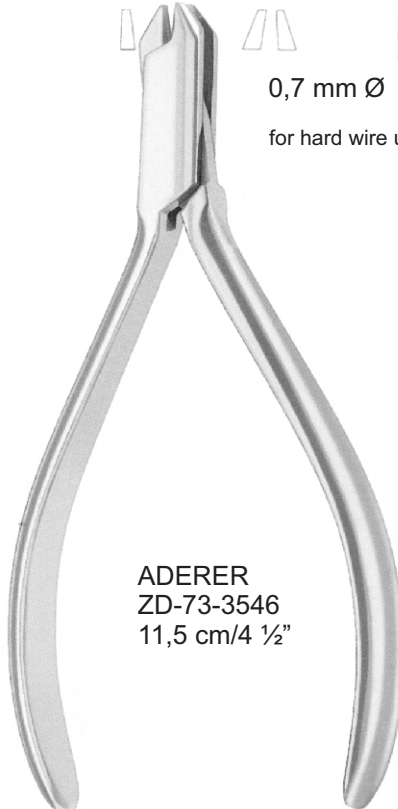

ADERER
 ZD-73-3546
 11,5 cm/4 1/2"

0,7 mm Ø
 for hard wire up to

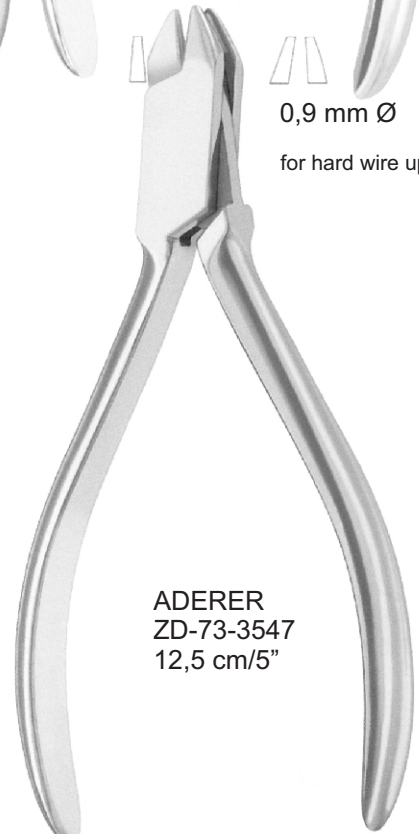

ADERER
 ZD-73-3547
 12,5 cm/5"

0,9 mm Ø
 for hard wire up to

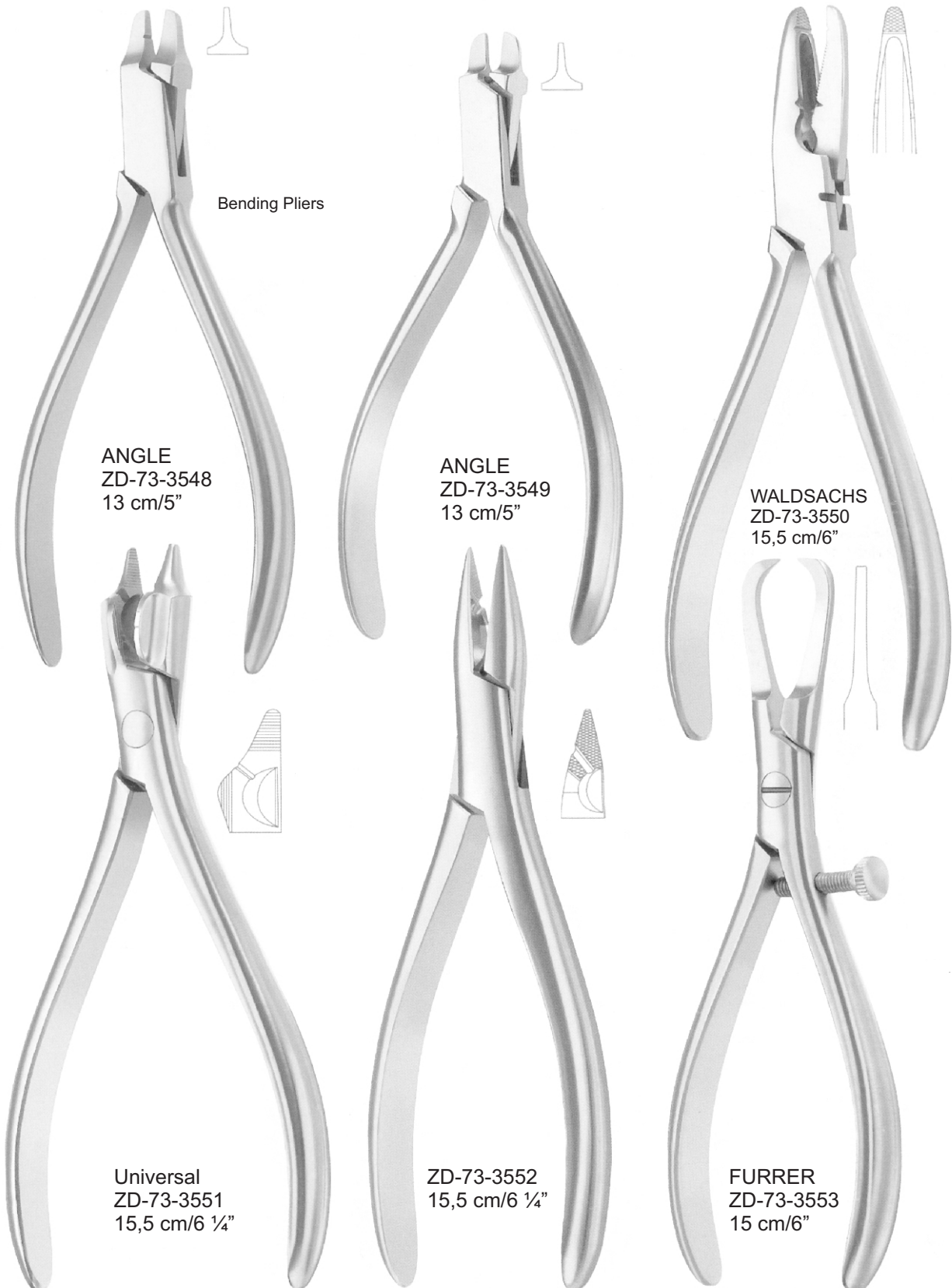

Bending Pliers

ANGLE
 ZD-73-3548
 13 cm/5"

ANGLE
 ZD-73-3549
 13 cm/5"

WALDSACHS
 ZD-73-3550
 15,5 cm/6"

Universal
 ZD-73-3551
 15,5 cm/6 ¼"

ZD-73-3552
 15,5 cm/6 ¼"

FURRER
 ZD-73-3553
 15 cm/6"

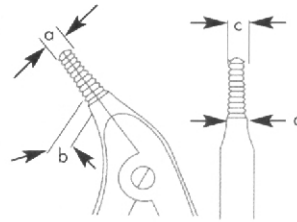

a	b	c	d
3,3	4	2,3	3,0
4,4	5	3,4	3,8

Telescope crown pliers

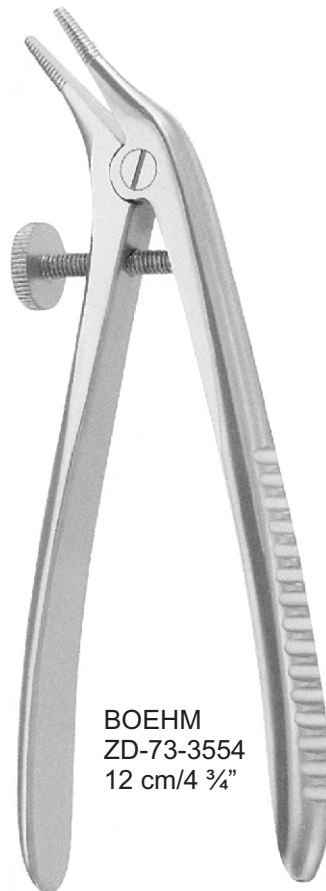

BOEHM
 ZD-73-3554
 12 cm/4 3/4"



BOEHM
 ZD-73-3555
 15 cm/4"



Step loop bending pliers



ORTHODONTICS



0,7 mm Ø

for hard wire up to



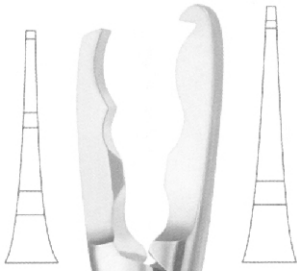

TRYFUS
 ZD-73-3567
 16 cm/6 1/4"



PEESO
 ZD-73-3568
 12 cm/6 1/4"



PEESO
 ZD-73-3569
 13,5 cm/5 1/4"

Crown
 stretching pliers



PEESO
 ZD-73-3570
 14 cm/5 1/2"



HOW
 ZD-73-3571
 14 cm/5 1/2"



HOW
 ZD-73-3572
 14 cm/5 1/2"



ZD-73-3573
 18 cm/7"



ZD-73-3574
 14,5 cm/5 ¾"



FREVERT
 ZD-73-3575
 12 cm/4 ¾"



TRIPLEX
 ZD-73-3576
 14 cm/5 ½"



REYNOLD
 ZD-73-3577
 12 cm/4 ¾"



GORDON
 ZD-73-3578
 13,5 cm/5 ¼"

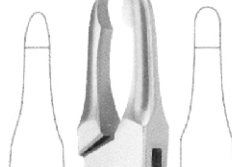

JOHNSON
 ZD-73-3579
 13 cm/5"

Clamping tweezer / bracket holder



ZD-73-3580 ZD-73-3581 ZD-73-3582 ZD-73-3583 ZD-73-3584 ZD-73-3585 ZD-73-3586 ZD-73-3587 Bracket P. Gauge ZD-73-3588 Band Remover ZD-73-3589 Band Remover

Bracket positioning gauge



ZD-73-3590



ZD-73-3591
12.5 cm/5"



ZD-73-3592
12.5 cm/5"



ZD-73-3593
12.5 cm/5"



ZD-73-3594
12.5 cm/5"



ZD-73-3595
12.5 cm/5"



ZD-73-3596
12.5 cm/5"



ZD-73-3597
12.5 cm/5"

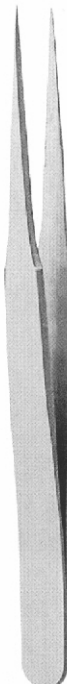

ZD-73-3598
12.5 cm/5"



ZD-73-3599
12.5 cm/5"



ZD-73-3600
12.5 cm/5"



ZD-73-3601
12.5 cm/5"



ZD-73-3602
12.5 cm/5"

74

- EN** Bone Rongeurs
- DE** Knochen Rongeur
- ES** Rongeurs de hueso

Page 191 to 193



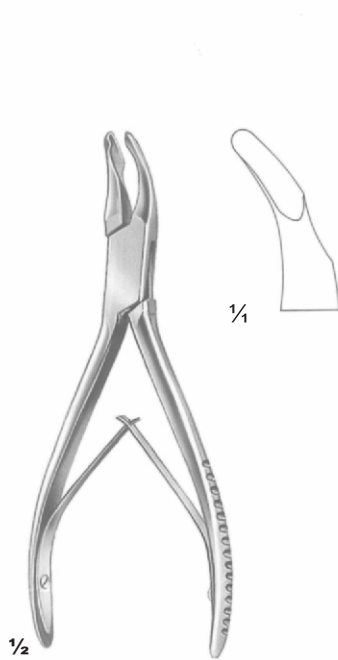

Cleveland
 ZD-74-3701
 15 cm

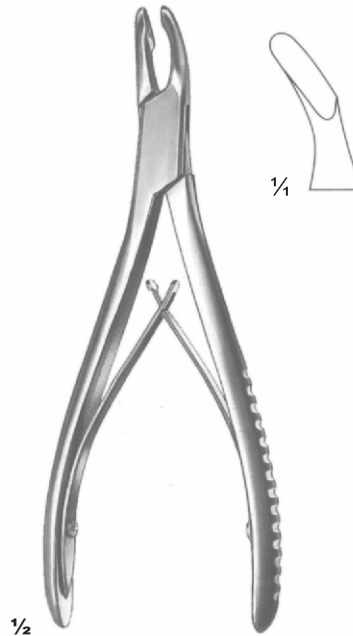

Cleveland
 ZD-74-3702
 15 cm

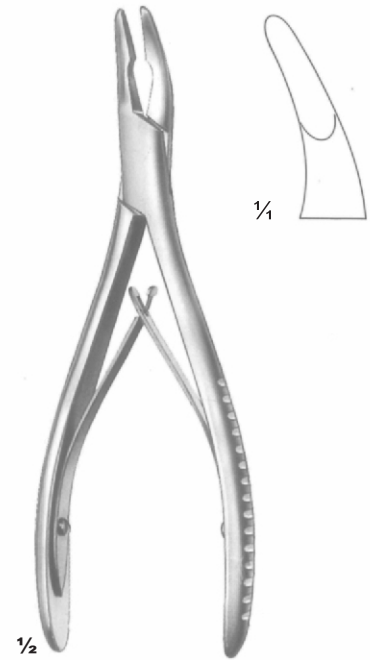

Hartmann
 ZD-74-3703
 18 cm

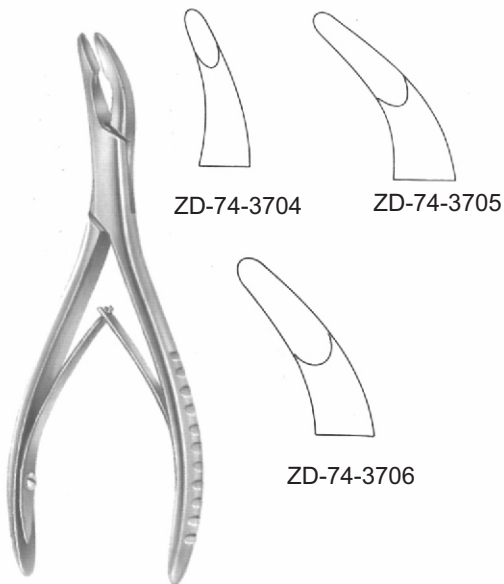

LUER
 15 cm

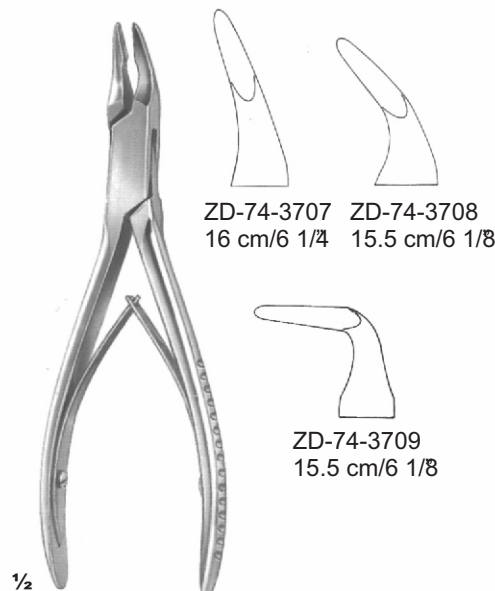

BLUMENTHAL
 15 cm

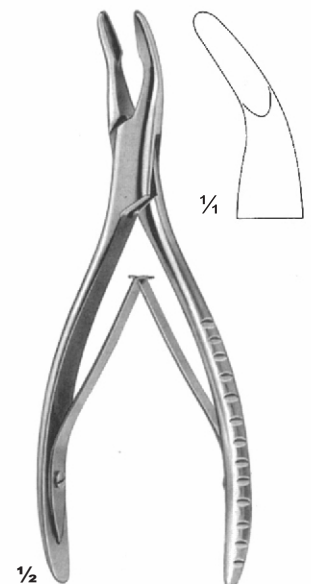

MEAD
 ZD-74-3710
 16.5 cm/6 1/2"

RONGEURS

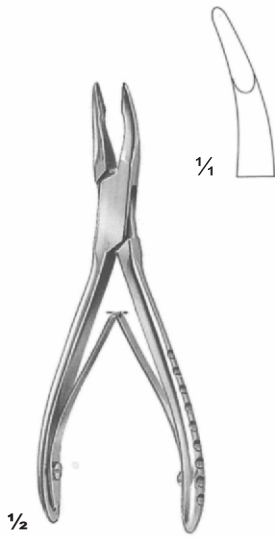

Friedmann
 ZD-74-3711
 14 cm

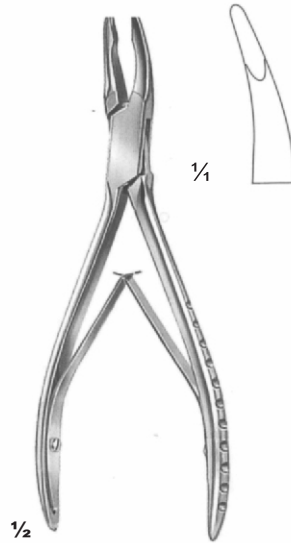

Friedmann
 ZD-74-3712
 14 cm

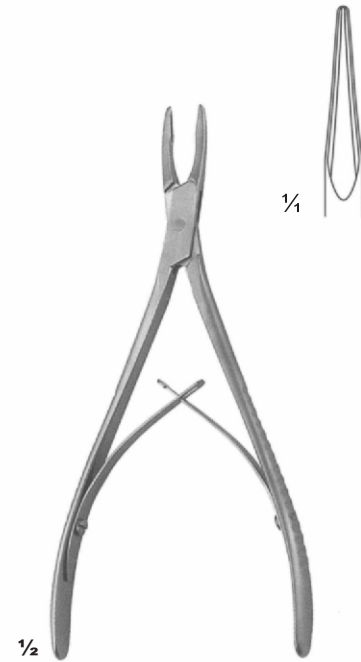

Friedmann-Micro
 ZD-74-3713
 15 cm/6"
 straight

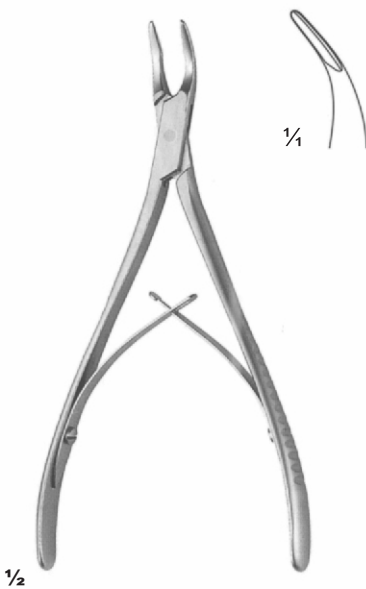

Friedmann-Micro
 ZD-74-3714
 15 cm/6"
 30°

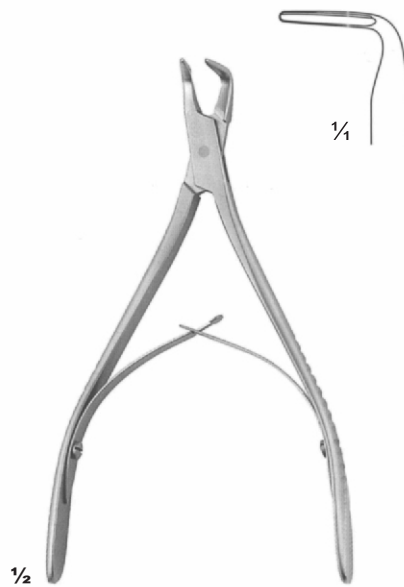

Friedmann-Micro
 ZD-74-3715
 14.5 cm/5 3/4"
 90°

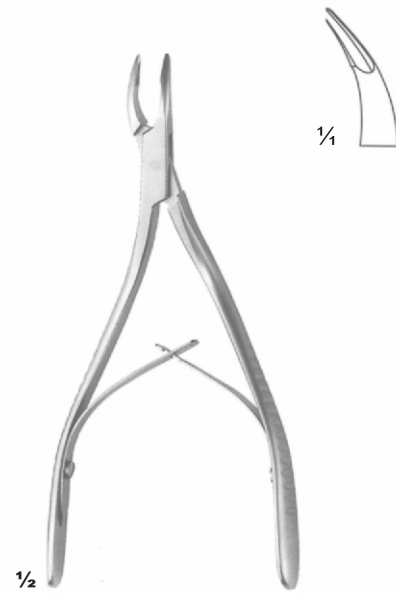

Friedmann-Micro
 ZD-74-3716
 14.5 cm/5 3/4"
 S shape
 30°

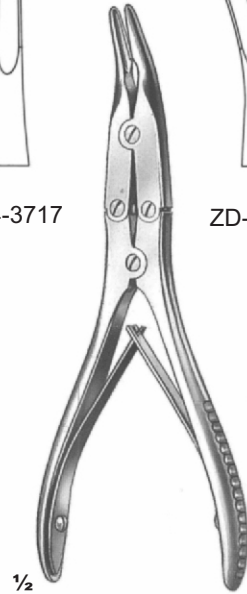
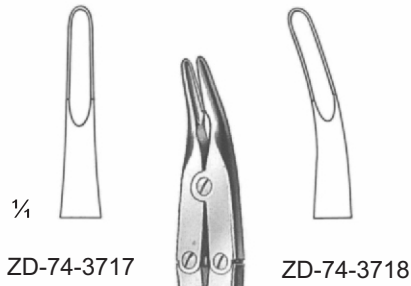

Bohler
15.5 cm/6"



Beyer
ZD-74-3719
18 cm/7"

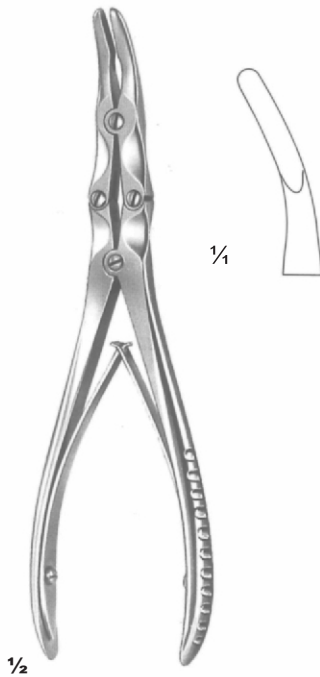

Mayfield
ZD-74-3720
18 cm/7"



Zaufal-Jansen
ZD-74-3721
18 cm/7"

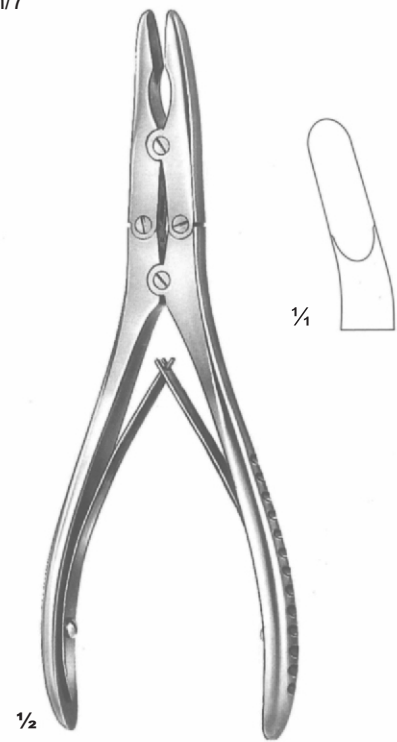

Ruskin
ZD-74-3722
19 cm/7 1/2"

75

- EN** Forceps
- DE** Zange
- ES** Fórceps



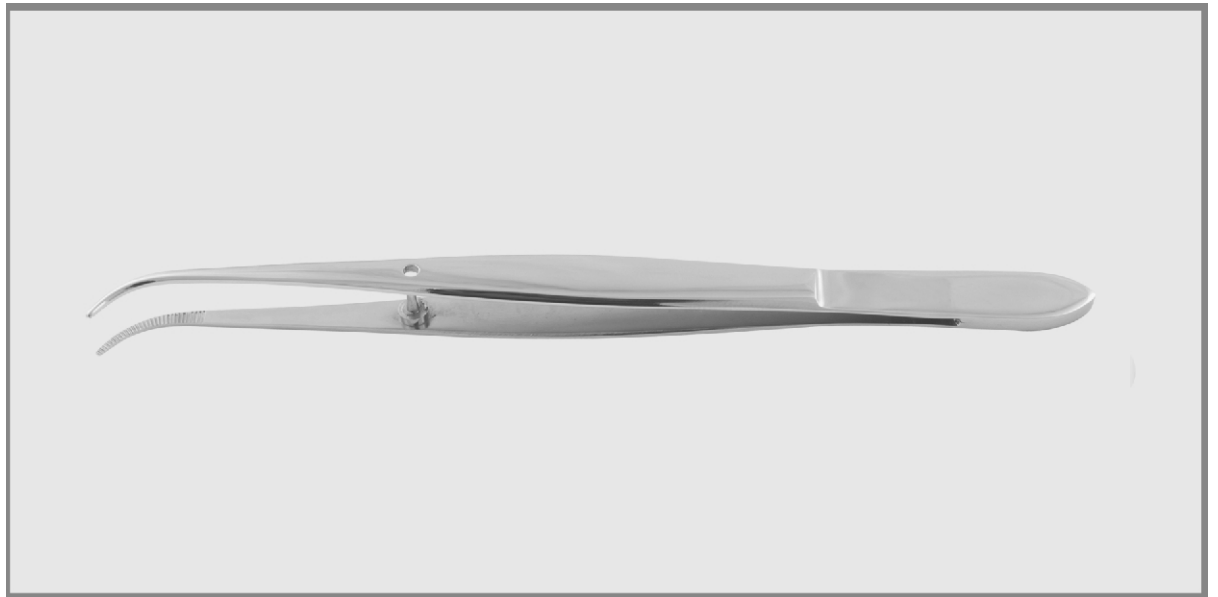

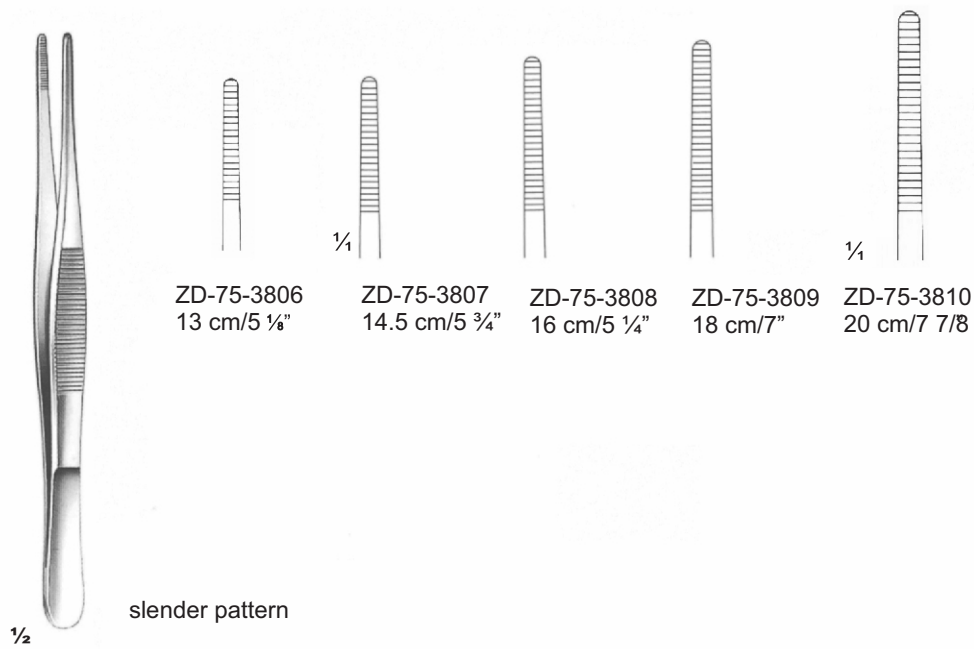
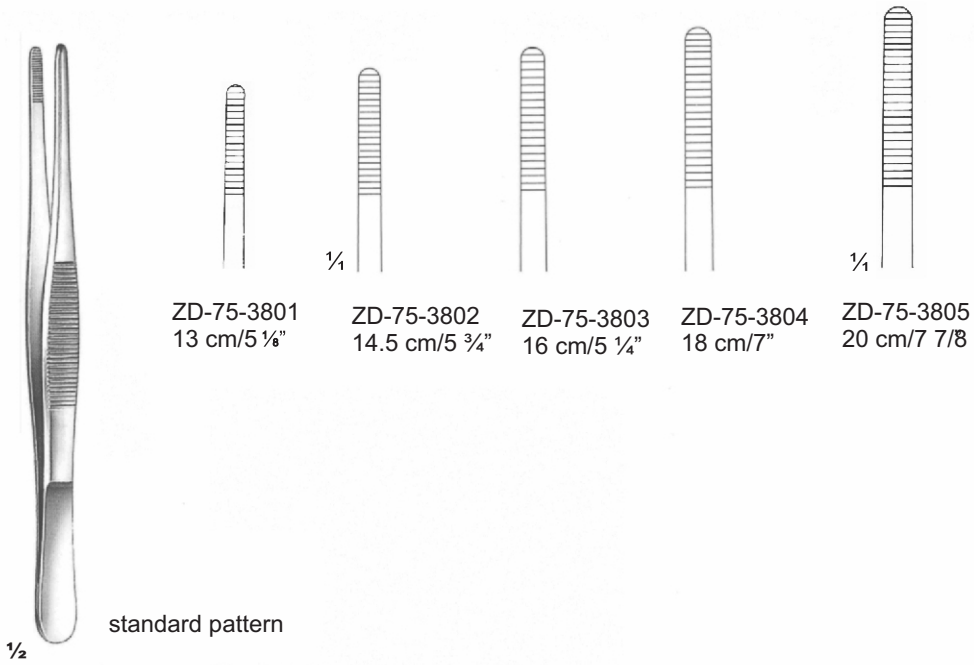
Page 194 to 201

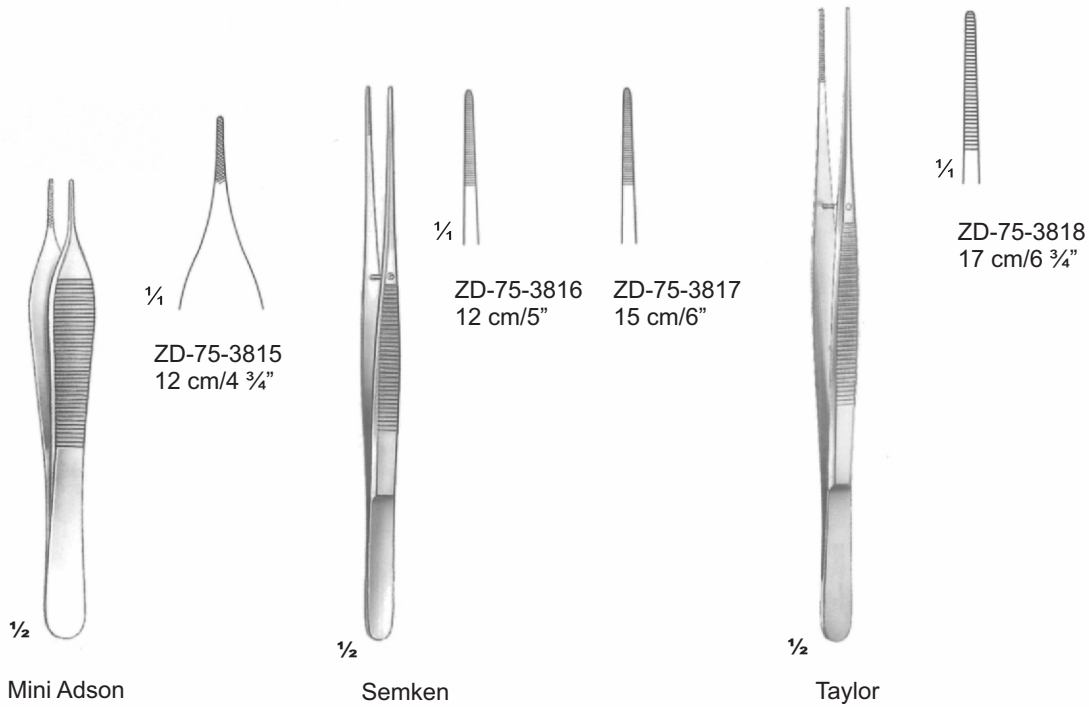
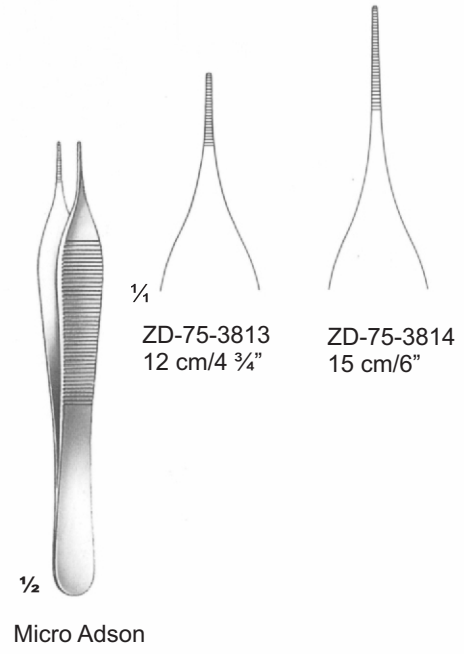
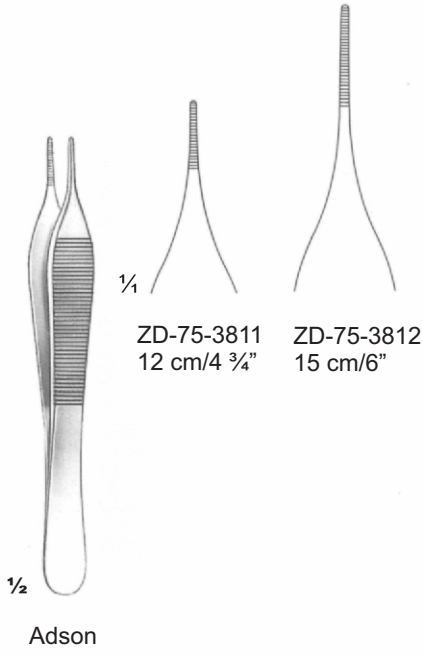











				
	¼			¼
ZD-75-3819 13 cm/5 ½" 1x2	ZD-75-3820 14.5 cm/5 ¾" 1x2	ZD-75-3821 16 cm/6 ¼" 1x2	ZD-75-3822 18 cm/7" 1x2	ZD-75-3823 20.5 cm/8 ½" 1x2



Standard Pattern



				
¼	¼			¼
ZD-75-3824 13 cm/5 ½" 1x2	ZD-75-3825 14.5 cm/5 ¾" 1x2	ZD-75-3826 16 cm/6 ¼" 1x2	ZD-75-3827 18 cm/7" 1x2	ZD-75-3828 20.5 cm/8 ½" 1x2



Slender Pattern



	
¼	¼
ZD-75-3829 12 cm/4 ¾" 1x2	ZD-75-3830 15 cm/5 ⅞" 1x2

Adson



	
¼	¼
ZD-75-3831 12 cm/4 ¾" 1x2	ZD-75-3832 12 cm/4 ¾" 1x2

Mini Adson

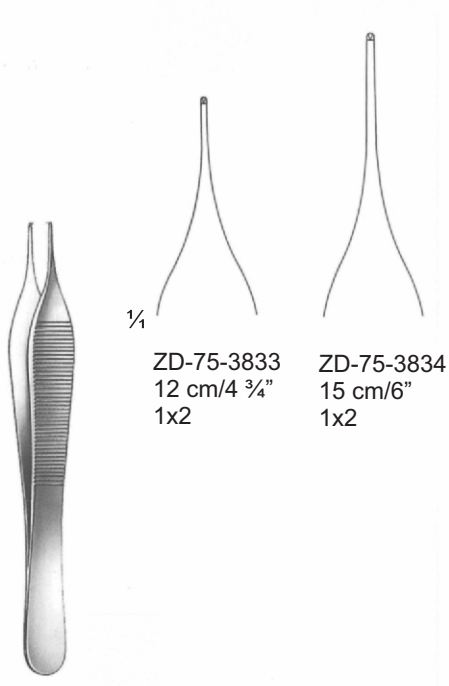

Mikro Adson

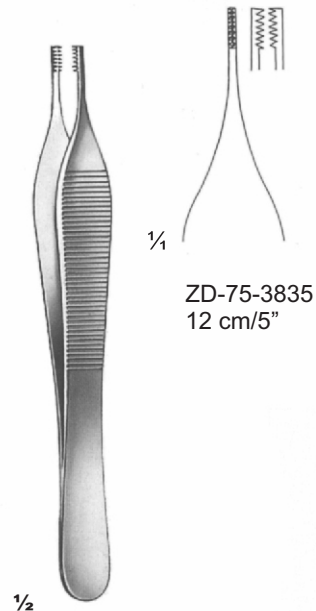

Adson-Brown

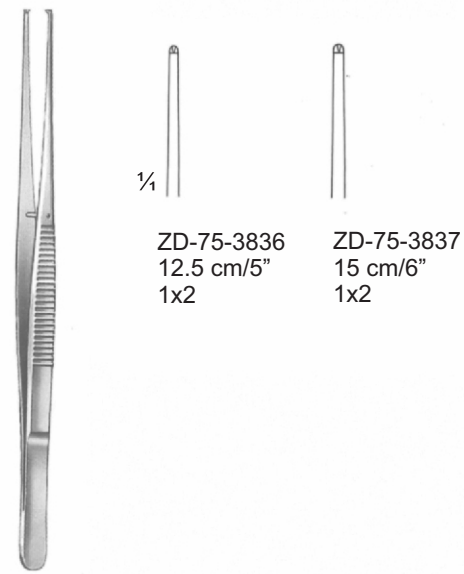

Semken

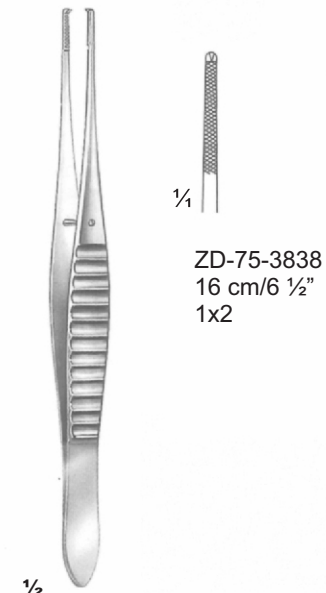

Gillies



1/4
 ZD-75-3838A
 15 cm/6"

suited to hold silver pins, nerve-broaches and for introducing medicines



1/2

Suture and membrane forceps

D = 1,6 mm



1/4
 ZD-75-3839
 16 cm/6 1/4"

D = 2,2 mm



1/4
 ZD-75-3840
 16 cm/6 1/4"



1/2

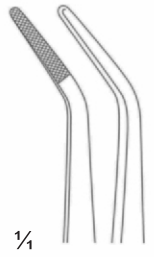

1/4
 ZD-75-3841
 16 cm/6 1/4"



1/2
 London-College
 15 cm/6"



1/4
 ZD-75-3842
 No. 1

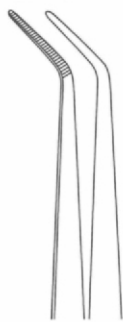

ZD-75-3843
 No. 3



ZD-75-3844
 No. 5



1/2
 London-College
 with lock
 15 cm/6"



1/4
 ZD-75-3845
 No. 1



ZD-75-3846
 No. 3



ZD-75-3847
 No. 5

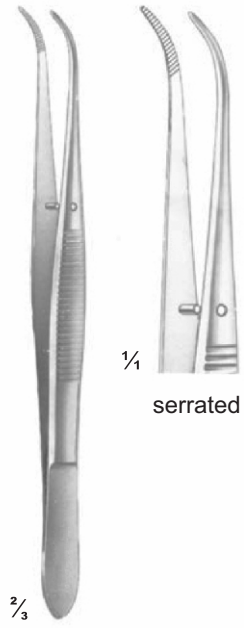
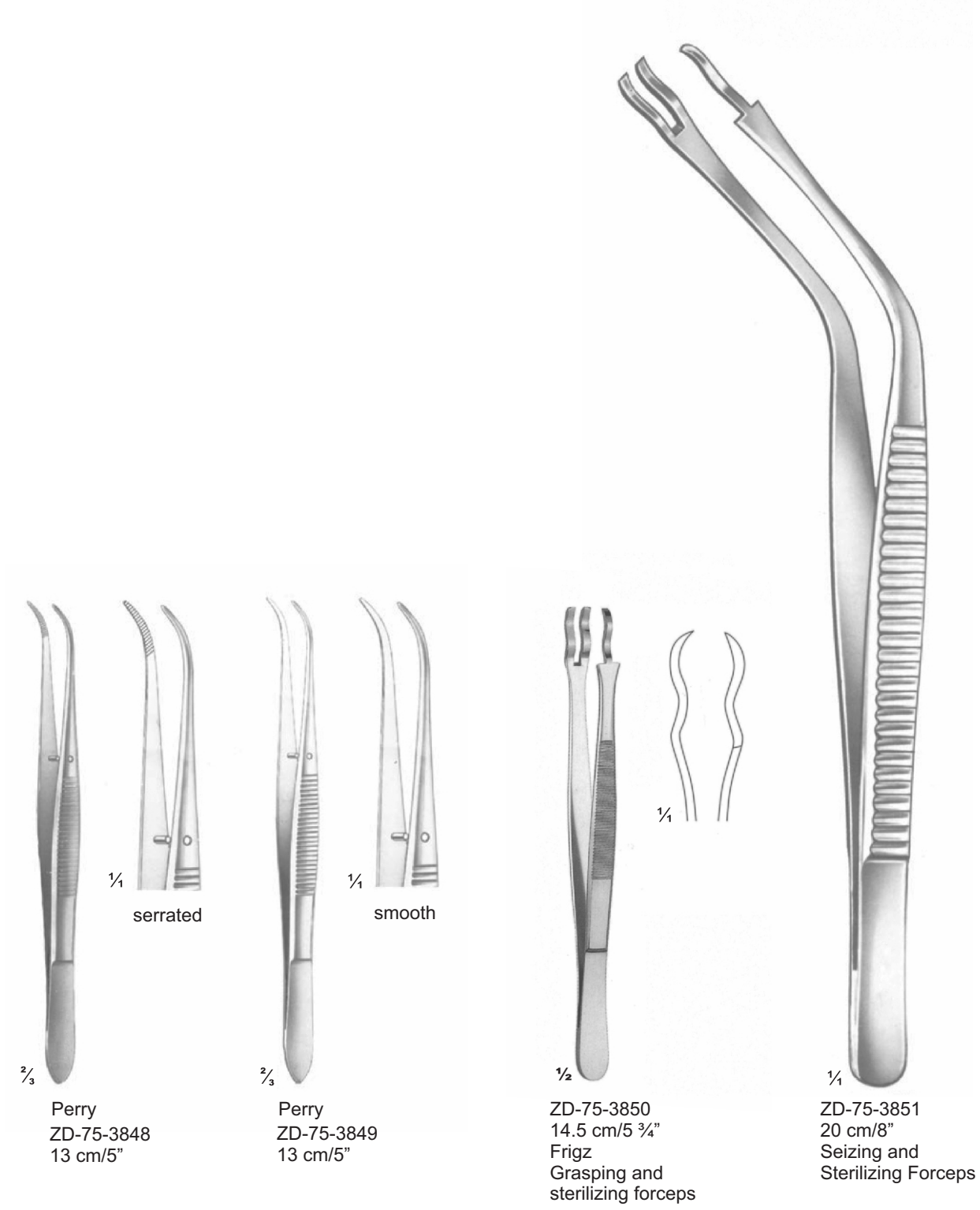

$\frac{2}{3}$
 Perry
 ZD-75-3848
 13 cm/5"

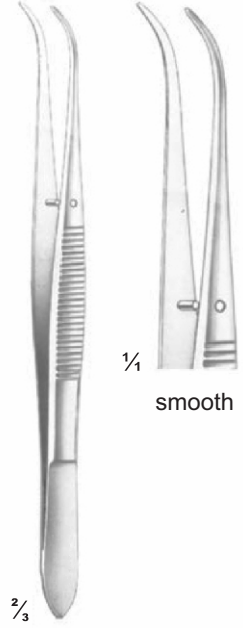

$\frac{2}{3}$
 Perry
 ZD-75-3849
 13 cm/5"

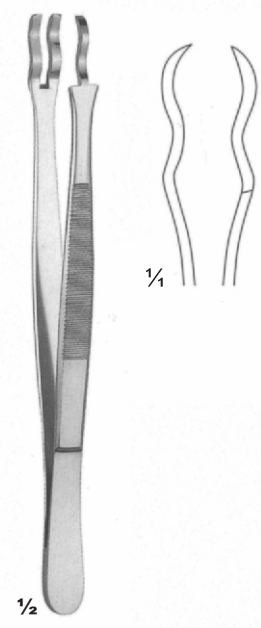

$\frac{1}{2}$
 ZD-75-3850
 14.5 cm/5 $\frac{3}{4}$ "
 Frigz
 Grasping and
 sterilizing forceps



$\frac{1}{4}$
 ZD-75-3851
 20 cm/8"
 Seizing and
 Sterilizing Forceps

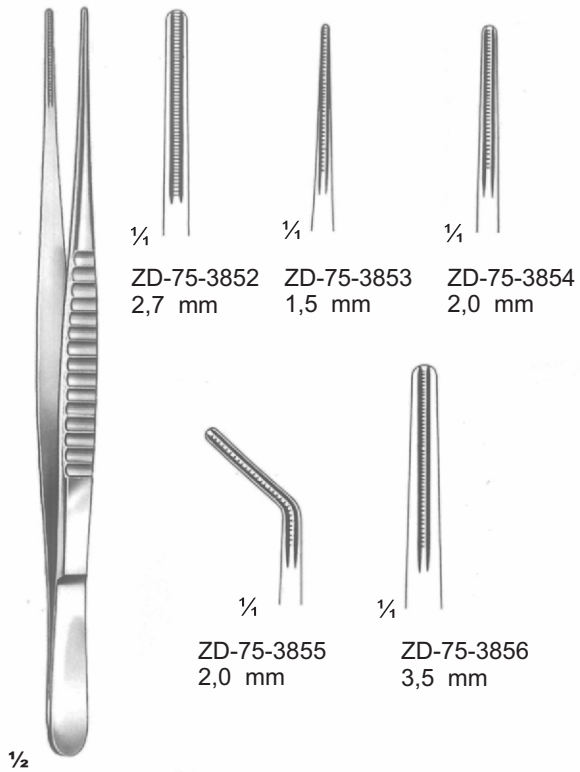

DeBakey
12 cm/5"

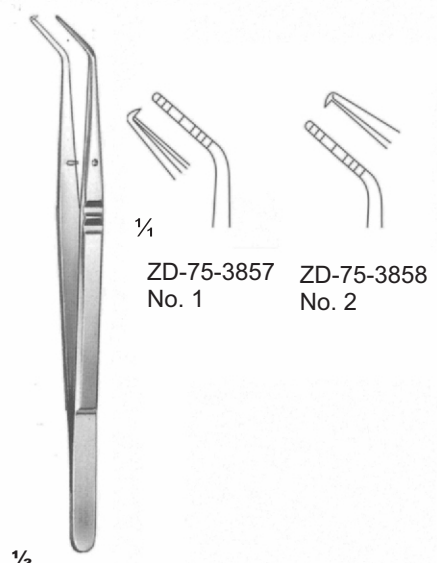

Crane-Kaplan
Pocket marking forceps
15 cm/6"

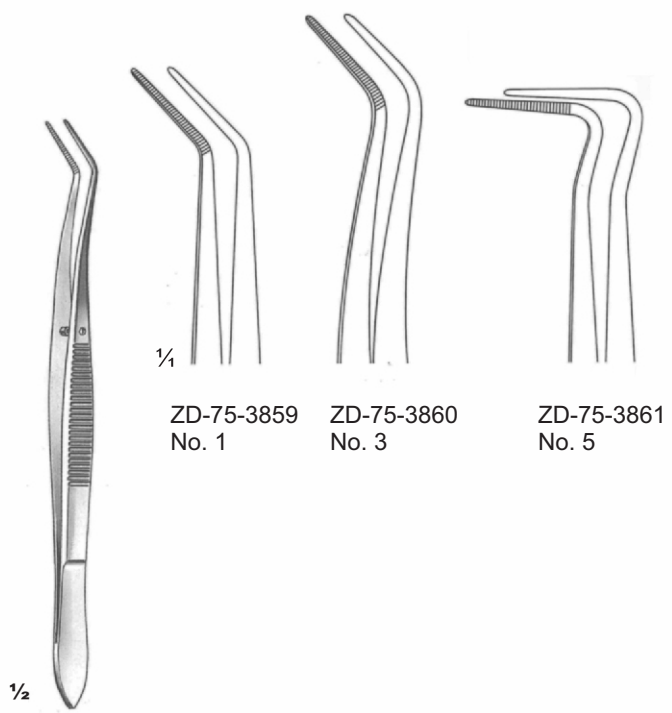

Meriam
16 cm/6 1/4"

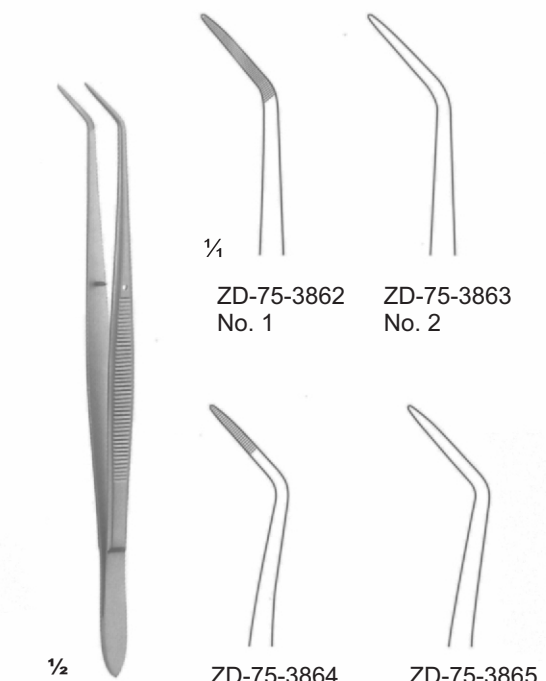

Flagg
16 cm/6 1/4"

Dressing Forceps ● EN
 Verbandzange ● DE
 Vendaje de fórceps ● ES



Standard

ZD-75-3866 TC
 14.5 cm/5 3/4"

ZD-75-3867 TC
 18 cm/ 7"



delicate

ZD-75-3868 TC
 14.5 cm/5 3/4"

ZD-75-3869 TC
 18 cm/7"

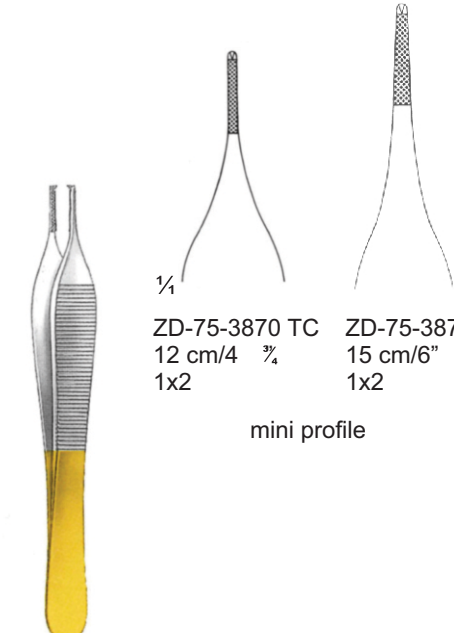

Adson

ZD-75-3870 TC
 12 cm/4 3/4
 1x2

ZD-75-3871 TC
 15 cm/6"
 1x2

mini profile

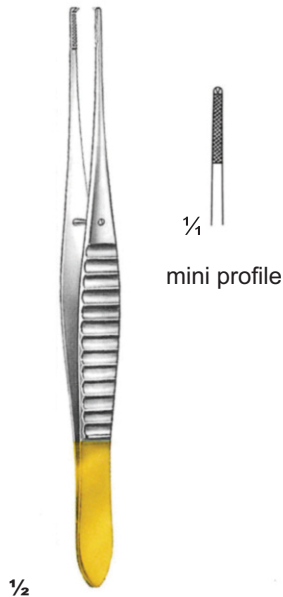

Gillies
 ZD-75-3872 TC
 15.5 cm/6"
 1x2

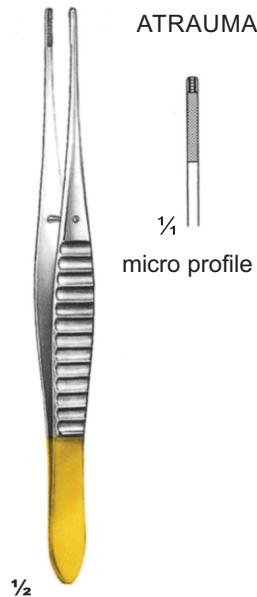

DeBakey
 ZD-75-3873 TC
 16 cm/6 1/4"

ATRAUMA

mini profile

micro profile

76

- EN** Scalpel Handles
- DE** Skalpellgriffe
- ES** Manches de bistouris

Page 202 to 203

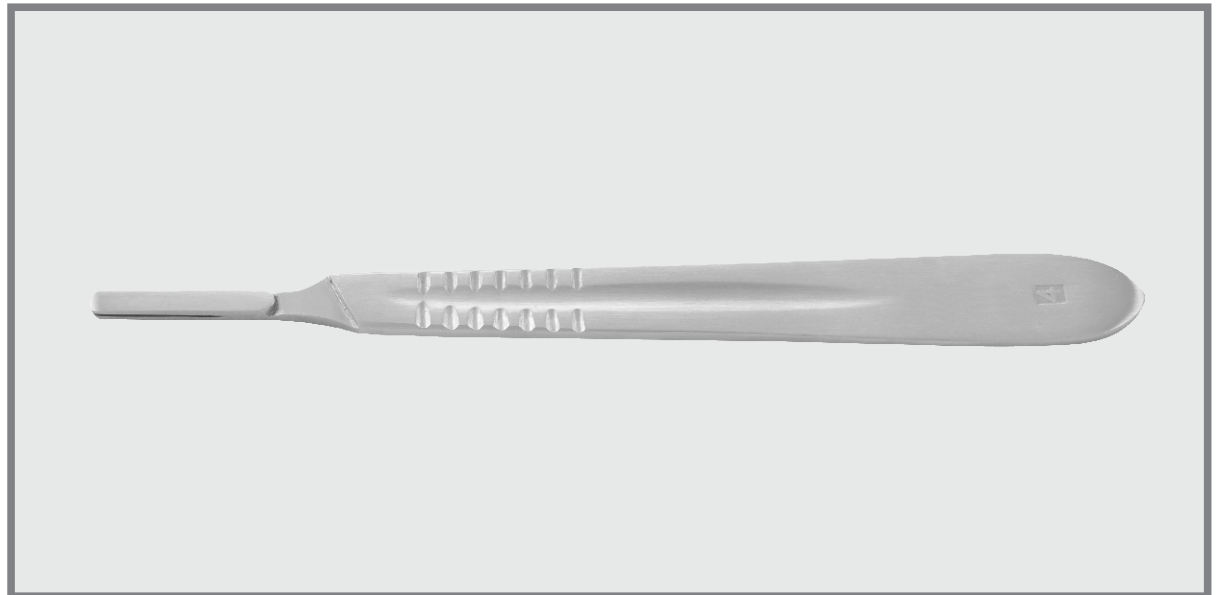

OPERATING KNIVES

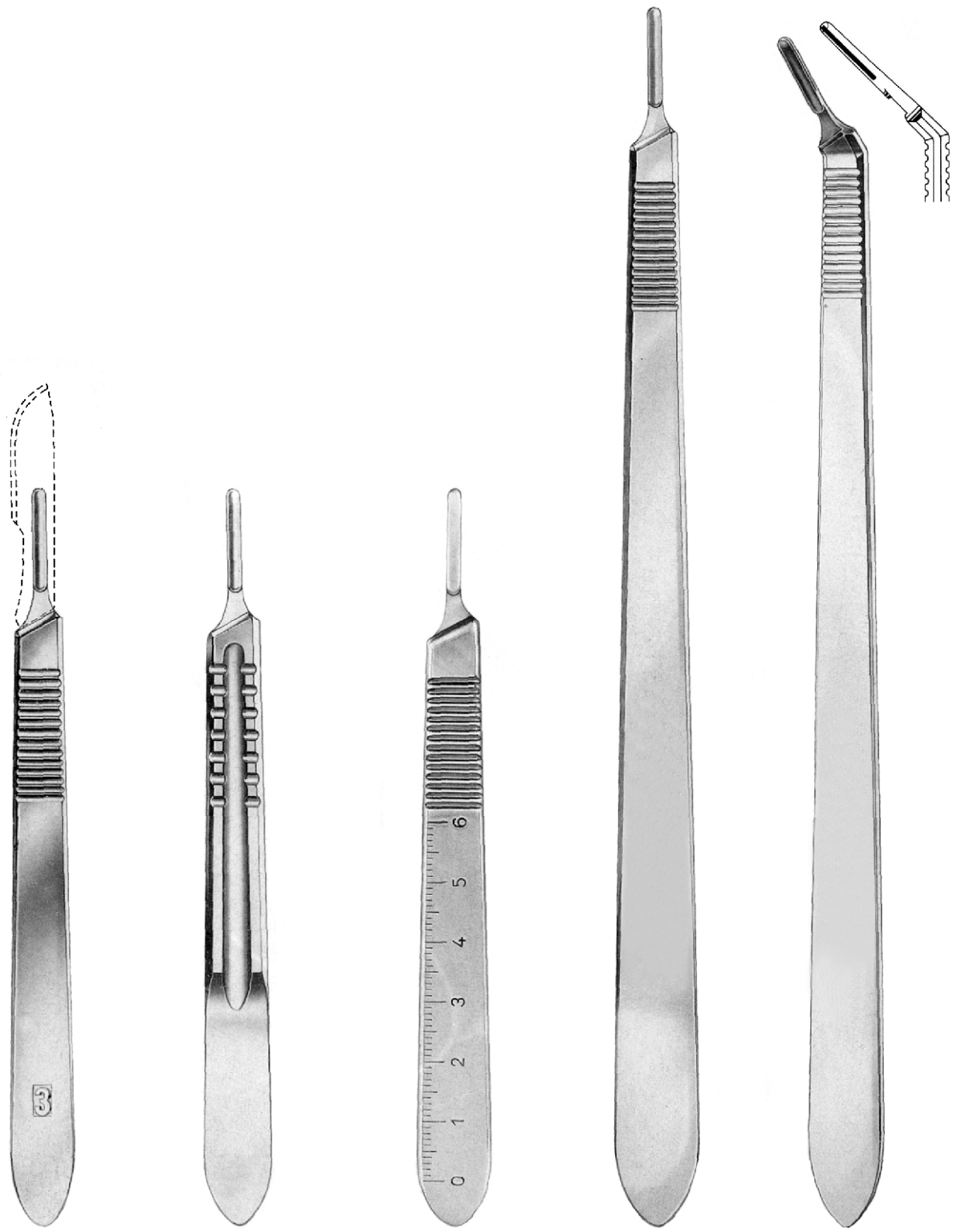

Standard
 ZD-76-3901 # 3

ZD-76-3902 # 3

ZD-76-3903 # 3
 with scale

ZD-76-3904-3L # 3L
 ZD-76-3905-3XL # 3XL

ZD-76-3906-3L # 3L
 ZD-76-3907-3XL # 3XL
 angled

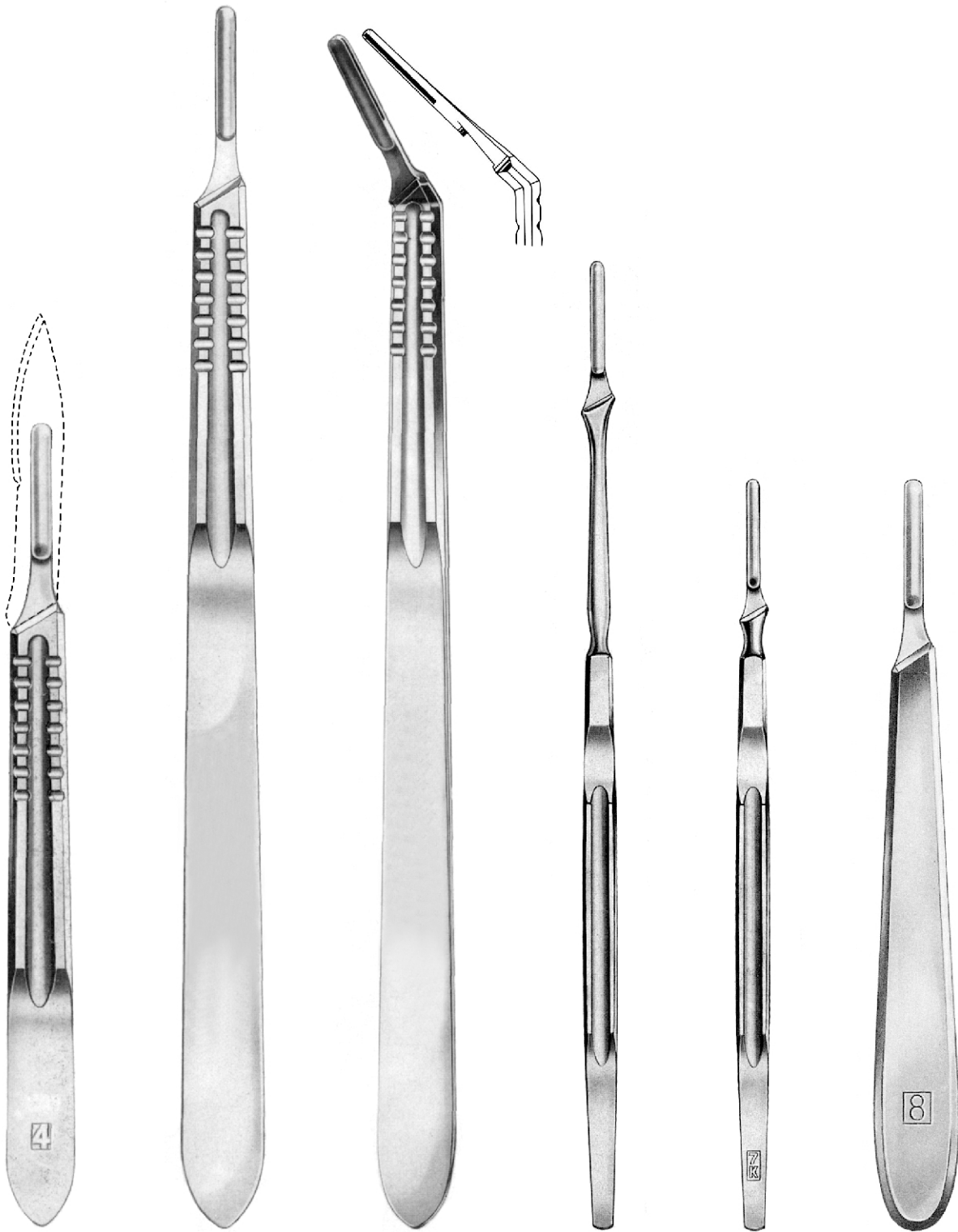

Standard
 ZD-76-3908 # 4

ZD-76-3909-4L # 4L
 ZD-76-3910-4XL # 4XL

ZD-76-3911-4L # 4L
 ZD-76-3912-4XL # 4XL
 angled

ZD-76-3913 # 7

ZD-76-3914 # 7K

Collin
 ZD-76-3915
 Fig. 8

77

- EN** Mallets
- DE** Schlägel
- ES** Mazos

Page 204 to 206

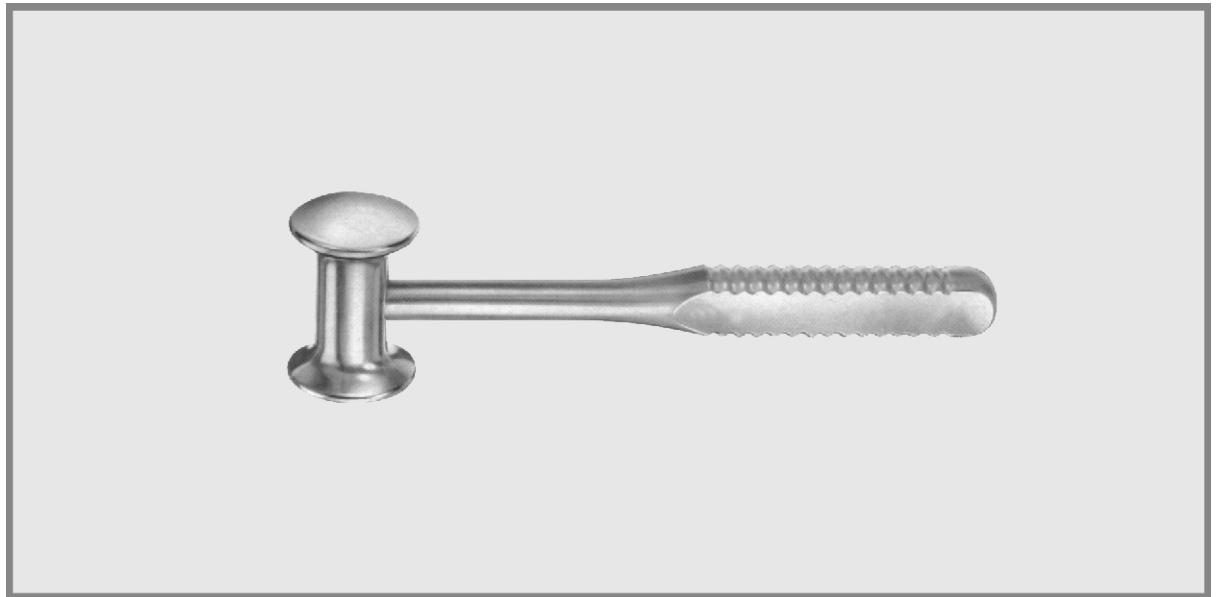

MALLETS

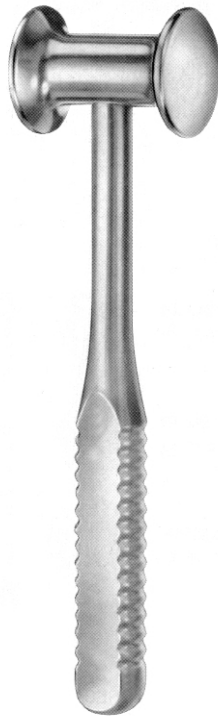

BERGMANN
 ZD-77-3951
 24 cm/9 1/2"
 300 grams



WILLIGER
 24 cm/9 1/2"
 lead filled

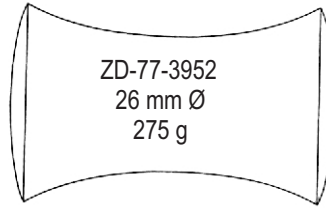

ZD-77-3952
 26 mm Ø
 275 g

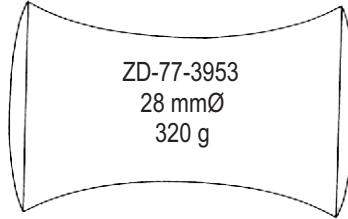

ZD-77-3953
 28 mm Ø
 320 g

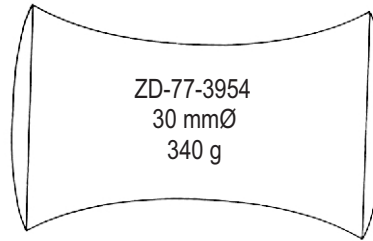

ZD-77-3954
 30 mm Ø
 340 g

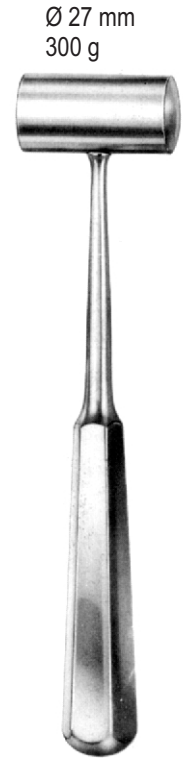

Ø 27 mm
 300 g

PARTSCH
 ZD-77-3955
 18 cm/7 1/8"
 with hollow handle



DOYEN
 21 cm/8 1/4"

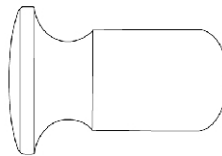

ZD-77-3956
 25 mm Ø
 120 g (4 1/4 oz.)
 19.5 cm/7 3/4"

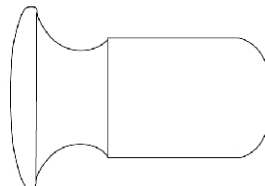

ZD-77-3957
 30 mm Ø
 180 g (6 1/2 oz.)
 19.5 cm/7 3/4"

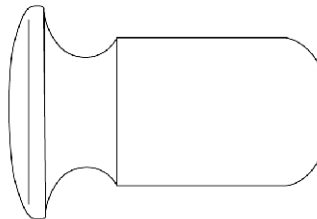

ZD-77-3958
 35 mm Ø
 260 g (9 oz.)
 21 cm/8 1/4"

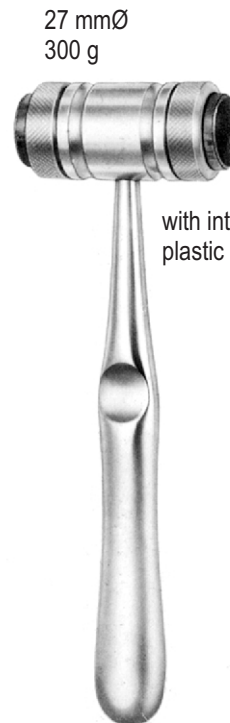

27 mm Ø
 300 g

with interchangeable plastic disks

MEAD
 ZD-77-3959 19 cm/7 1/2"
 ZD-77-3960 pair of spare disks

Mallets ● EN
 Hämmer ● DE
 Martillos ● ES



HAJEK
 ZD-77-3961
 20 cm/7⁷/₈"
 200 g
 Ø 27 mm



KIRK
 ZD-77-3962
 21 cm/8¹/₄"
 650 g
 Ø 38 mm

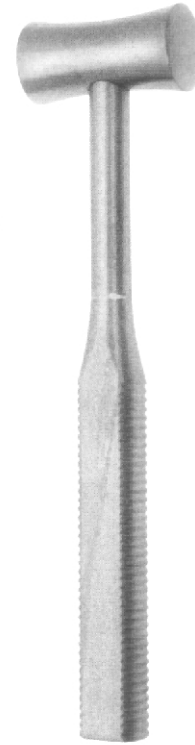

BERGMANN
 ZD-77-3963
 24.5 cm/9⁵/₈"
 400 g
 Ø 30 mm

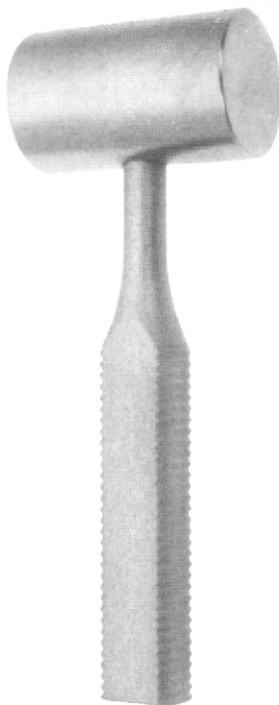

HEATH
 ZD-77-3964
 18.5 cm/7¹/₄"
 700 g
 Ø 40 mm

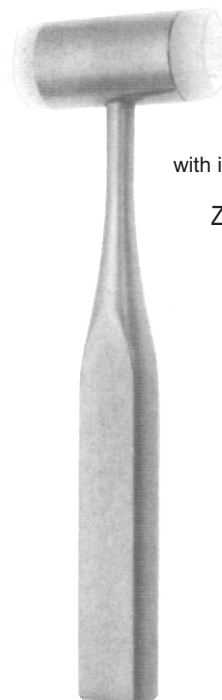

with interchangeable
 disks
 ZD-77-3966

ZD-77-3965
 18.5 cm/7¹/₄"
 240 g
 Ø 25 mm

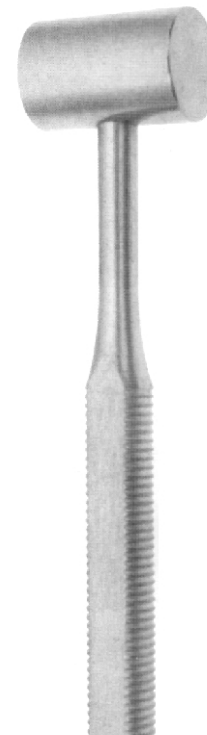

OMBREDANNE
 ZD-77-3967
 24 cm/9¹/₂"
 700 g
 Ø 40 mm



ZD-77-3968
 26.5 cm/10 3/8"
 Ø 50 mm
 1300 g

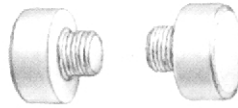

ZD-77-3969
 spare facings (pair)

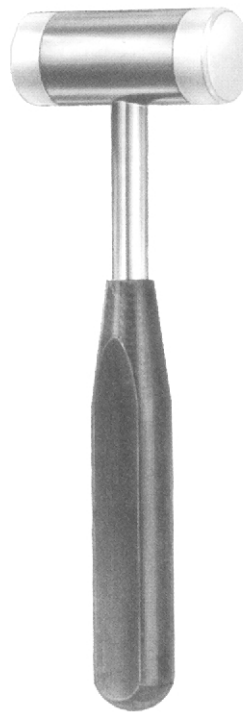

ZD-77-3970
 19 cm/7 1/2"
 Ø 25 mm
 300 g



HERBERT
 ZD-77-3971
 19 cm/7 1/2"
 Ø 25 mm
 215 g

78

EN Cassettes

DE Kassetten

ES Cassettes

Page 207 to 210





Elongated Holes

		<u>Dimension(mm)</u>
ZD-78-4001	05-Instruments	78 x 182 x 32
ZD-78-4002	10-Instruments	142 x 182 x 32
ZD-78-4003	20-Instruments	270 x 182 x 32



Round Bottom with Strip Lock

		<u>Dimension(mm)</u>
ZD-78-4004	05-Instruments	90 x 182 x 25
ZD-78-4005	10-Instruments	145 x 182 x 25
ZD-78-4006	20-Instruments	270 x 182 x 25



Square

		<u>Dimension(mm)</u>
ZD-78-4007	05-Instruments	180 x 70 x 22
ZD-78-4008	10-Instruments	180 x 130 x 22
ZD-78-4009	20-Instruments	260 x 180 x 22

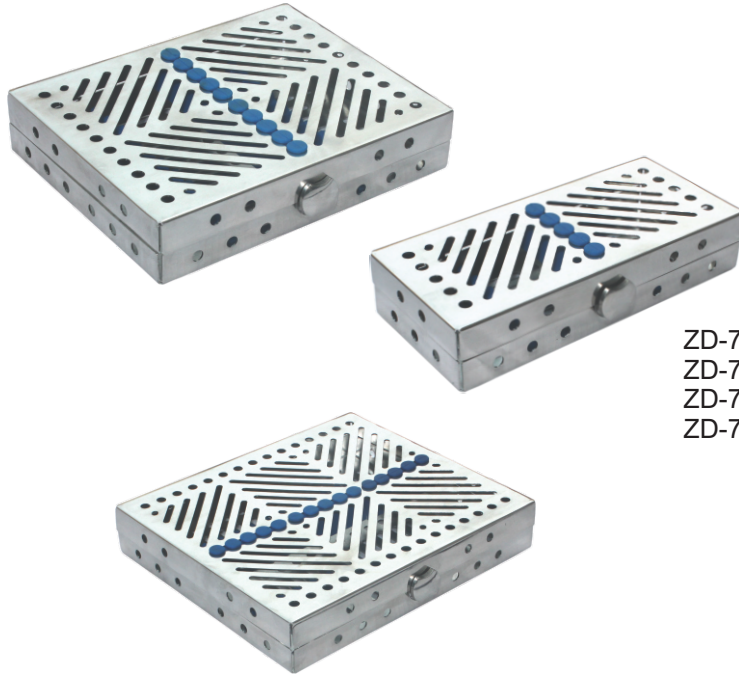

Elongated Holes

		<u>Dimension(mm)</u>
ZD-78-4010	05-Instruments	180 x 80 x 35
ZD-78-4011	10-Instruments	180 x 145 x 35
ZD-78-4012	15-Instruments	210 x 180 x 35
ZD-78-4013	20-Instruments	280 x 180 x 35

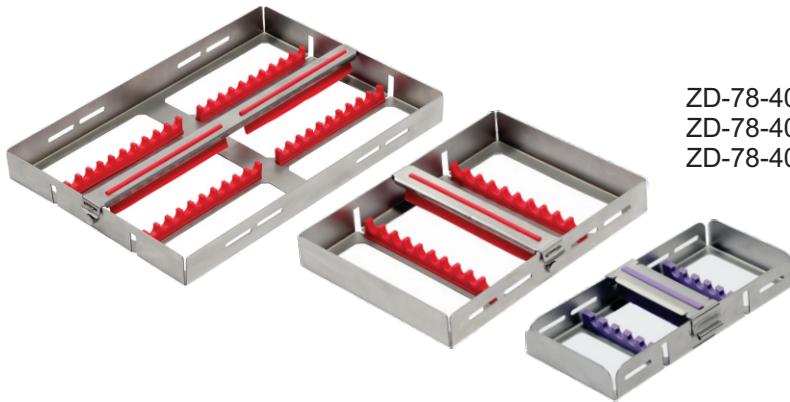

Strip Lock "H" Type

<u>Model</u>		<u>Dimension(mm)</u>
ZD-78-4014	05-Instruments	180 x 80 x 25
ZD-78-4015	10-Instruments	180 x 130 x 25
ZD-78-4016	20-Instruments	260 x 180 x 25

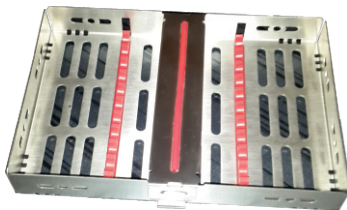

Strip Lock

<u>Model</u>		<u>Dimension(mm)</u>
ZD-78-4017	05-Instruments	180 x 80 x 25
ZD-78-4018	10-Instruments	180 x 130 x 25
ZD-78-4019	20-Instruments	260 x 180 x 25



	<u>Dimension(mm)</u>
ZD-78-4020	405 x 255 x 50
ZD-78-4021	405 x 255 x 70
ZD-78-4022	405 x 255 x 100



	<u>Dimension(mm)</u>
ZD-78-4023	255 x 245 x 50
ZD-78-4024	255 x 245 x 70
ZD-78-4025	255 x 245 x 100



	<u>Dimension(mm)</u>
ZD-78-4026	255 x 120 x 50
ZD-78-4027	255 x 120 x 70

LIDs (optional)

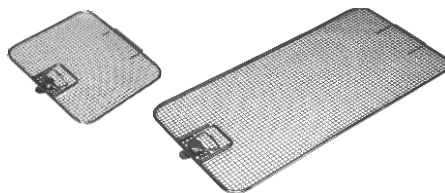

	<u>Dimension(mm)</u>
ZD-78-4028	255 x 120
ZD-78-4029	255 x 245
ZD-78-4030	250 x 240
ZD-78-4031	540 x 255
ZD-78-4032	485 x 255
ZD-78-4033	405 x 255
ZD-78-4034	480 x 370
ZD-78-4035	480 x 250

Endoscopic Baskets

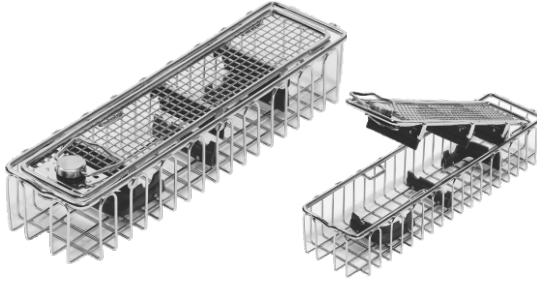

Dimension(mm)

ZD-78-4036	290 x 80 x 52
ZD-78-4037	460 x 80 x 52



Dimension(mm)

ZD-78-4038	670 x 80 x 52
ZD-78-4039	700 x 80 x 52



Dimension(mm)

ZD-78-4040	290 x 160 x 52
ZD-78-4041	310 x 150 x 77
ZD-78-4042	460 x 160 x 77
ZD-78-4043	640 x 150 x 77
ZD-78-4044	660 x 150 x 77
ZD-78-4045	460 x 160 x 52
ZD-78-4046	580 x 160 x 52

79

- EN** Cylinder cartridge syringe
- DE** Zylinder-Ampullenspritze
- ES** Seringue á ampoule cilindrique

Page 211 to 216

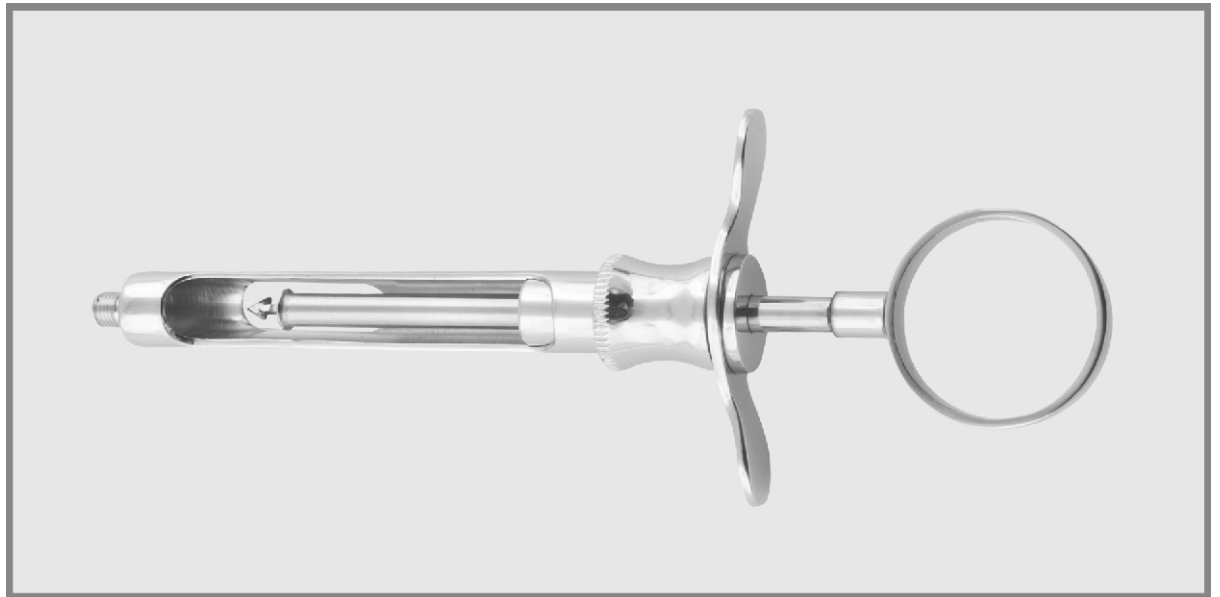



ZD-79-4101

Cylinder cartridge syringe
 1.8 cc, without aspiration
 metric thread / US Thread

ZD-79-4102

Cylinder cartridge syringe
 1.8 cc, with aspiration
 metric thread / US Thread

ZD-79-4103

Cylinder cartridge syringe
 2.2 cc, without aspiration
 metric thread / US Thread

ZD-79-4104

Cylinder cartridge syringe
 2.2 cc, with aspiration
 metric thread / US Thread



ZD-79-4105

Cylinder cartridge syringe
 1.8 cc, without aspiration with
 metric thread / US Thread

ZD-79-4106

Cylinder cartridge syringe
 1.8 cc, with aspiration with
 metric thread / US Thread

ZD-79-4107

Cylinder cartridge syringe
 2.2 cc, without aspiration with
 metric thread / US Thread

ZD-79-4108

Cylinder cartridge syringe
 2.2 cc, with aspiration with
 metric thread / US Thread

SYRINGES



ZD-79-4109

Cylinder cartridge syringe
 1.8 cc, without aspiration
 metric thread / US Thread

ZD-79-4111

Cylinder cartridge syringe
 2.2 cc, without aspiration
 metric thread / US Thread

ZD-79-4110

Cylinder cartridge syringe
 1.8 cc, with aspiration
 metric thread / US Thread

ZD-79-4112

Cylinder cartridge syringe
 2.2 cc, with aspiration
 metric thread / US Thread



ZD-79-4113
 Cylinder Cartridge Syringe
 1.8cc without Aspiration
 metric thread / US Thread

ZD-79-4115
 Cylinder Cartridge Syringe
 2.2cc without Aspiration
 metric thread / US Thread

ZD-79-4114
 Cylinder Cartridge Syringe
 1.8cc with Aspiration
 metric thread / US Thread

ZD-79-4116
 Cylinder Cartridge Syringe
 2.2cc with Aspiration
 metric thread / US Thread



ZD-79-4117
 Cylinder Cartridge Syringe
 1.8cc without Aspiration
 metric thread / US Thread
 Plastic base & handle sand blast
 finish steel rod.

ZD-79-4118
 Cylinder Cartridge Syringe
 1.8cc with Aspiration
 metric thread / US Thread
 Plastic base & handle sand blast
 finish steel rod.

ZD-79-4119
 Cylinder Cartridge Syringe
 2.2cc without Aspiration
 metric thread / US Thread
 Plastic base & handle sand blast
 finish steel rod.

ZD-79-4120
 Cylinder Cartridge Syringe
 2.2cc with Aspiration
 metric thread / US Thread
 Plastic base & handle sand blast
 finish steel rod.



ZD-79-4121
 Cylinder Cartridge Syringe
 1.8cc without Aspiration
 metric thread / US Thread

ZD-79-4122
 Cylinder Cartridge Syringe
 1.8cc with Aspiration
 metric thread / US Thread

ZD-79-4123
 Cylinder Cartridge Syringe
 2.2cc without Aspiration
 metric thread / US Thread

ZD-79-4124
 Cylinder Cartridge Syringe
 2.2cc with Aspiration
 metric thread / US Thread

SYRINGES



ZD-79-4125
 Cylinder Cartridge Syringe
 1.8cc without Aspiration
 metric thread / US Thread

ZD-79-4127
 Cylinder Cartridge Syringe
 2.2cc without Aspiration
 metric thread / US Thread

ZD-79-4126
 Cylinder Cartridge Syringe
 1.8cc with Aspiration
 metric thread / US Thread

ZD-79-4128
 Cylinder Cartridge Syringe
 2.2cc with Aspiration
 metric thread / US Thread



ZD-79-4129
 Cylinder Cartridge Syringe
 1.8cc without Aspiration
 metric thread / US Thread

ZD-79-4131
 Cylinder Cartridge Syringe
 2.2cc without Aspiration
 metric thread / US Thread

ZD-79-4130
 Cylinder Cartridge Syringe
 1.8cc with Aspiration
 metric thread / US Thread

ZD-79-4132
 Cylinder Cartridge Syringe
 2.2cc with Aspiration
 metric thread / US Thread



ZD-79-4133
 Cylinder Cartridge Syringe
 1.8cc without Aspiration
 metric thread / US Thread

ZD-79-4134
 Cylinder Cartridge Syringe
 1.8cc with Aspiration
 metric thread / US Thread

ZD-79-4135
 Cylinder Cartridge Syringe
 2.2cc without Aspiration
 metric thread / US Thread

ZD-79-4136
 Cylinder Cartridge Syringe
 2.2cc with Aspiration
 metric thread / US Thread



ZD-79-4137
 Aspirating Syringe
 1.8cc with fix tip, S/S
 metric thread / US Thread

ZD-79-4138
 Aspirating Syringe
 2.2cc with fix tip, S/S
 metric thread / US Thread

SYRINGES

Intra-Ligamentale Syringes

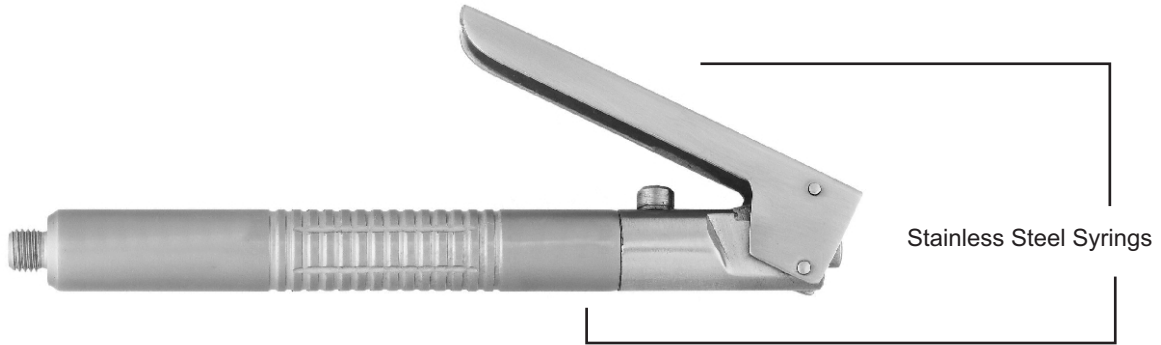

ZD-79-4139
 1.8 cc metric thread / US Thread
 2.2 cc metric thread / US Thread

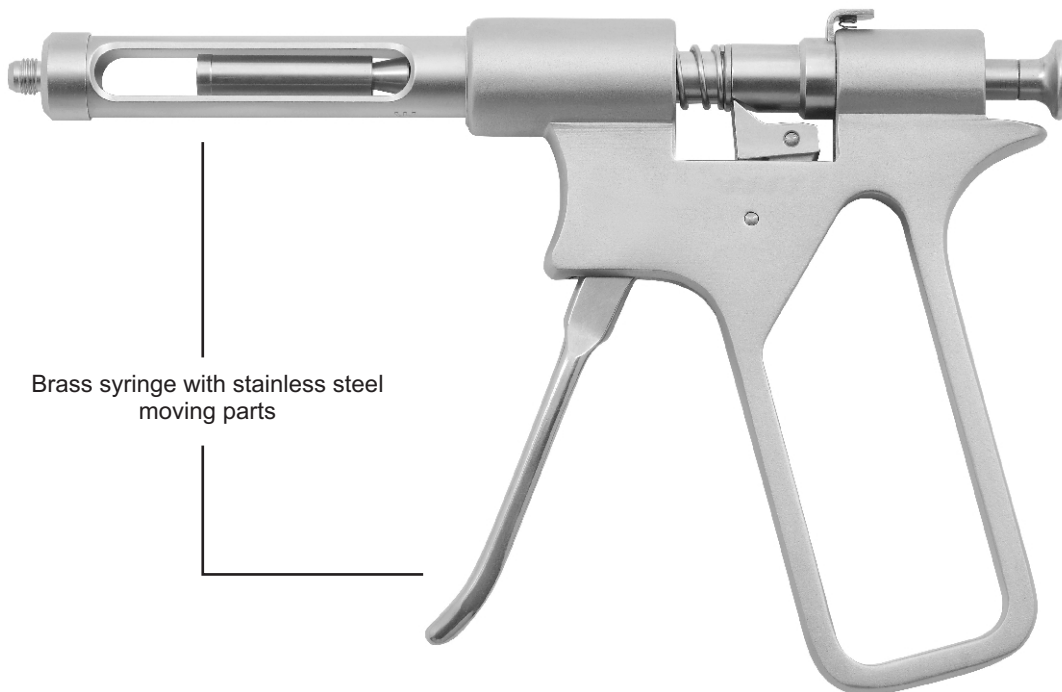

ZD-79-4140
 1.8 cc metric thread / US Thread
 2.2 cc metric thread / US Thread

80

- EN** Impression Trays
- DE** Abdrucklöffel
- ES** Porte empreintes

Page 217 to 228

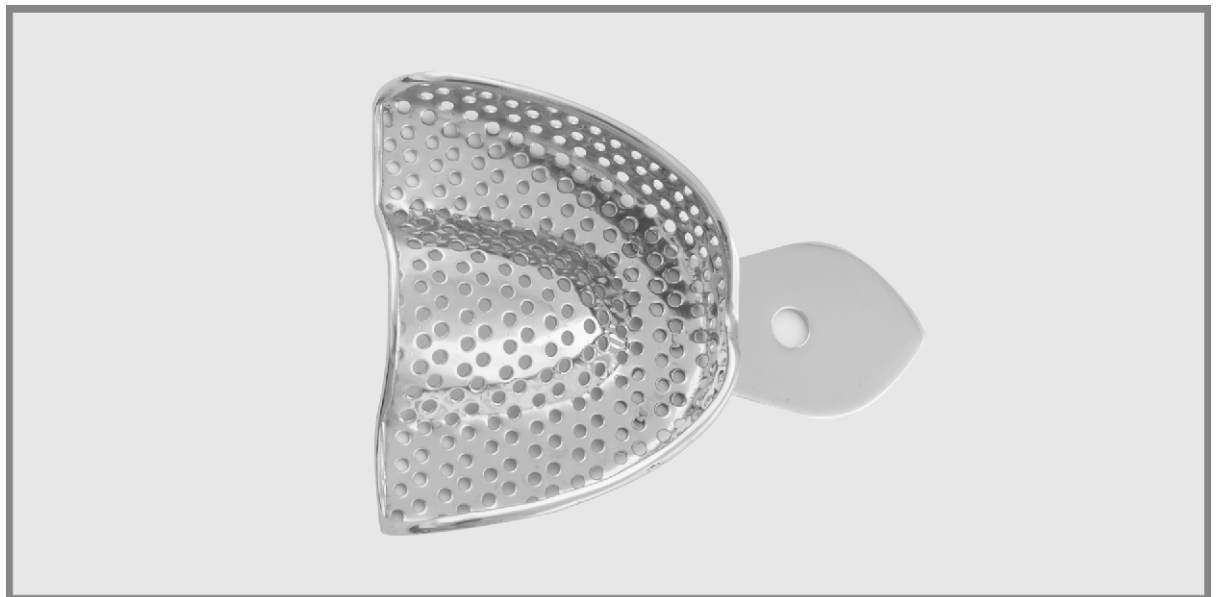

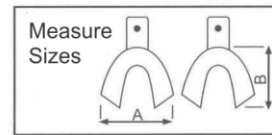
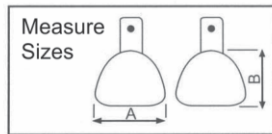
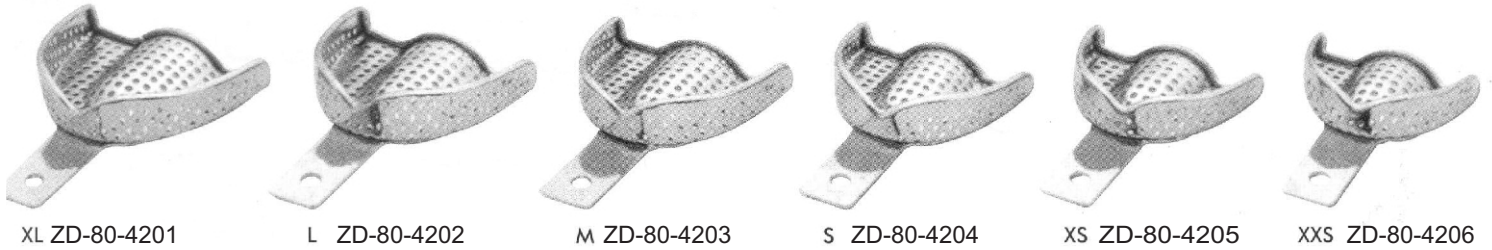

Upper		A (left-right)	B (top-bottom)
80-4201	XL	81 mm	63 mm
80-4202	L	73 mm	58 mm
80-4203	M	71 mm	52 mm
80-4204	S	67 mm	53 mm
80-4205	XS	65 mm	51 mm
80-4206	XXS	61 mm	50 mm

Lower		A (left-right)	B (top-bottom)
80-4207	XL	78 mm	63 mm
80-4208	L	74 mm	62 mm
80-4209	M	72 mm	59 mm
80-4210	S	70 mm	57 mm
80-4211	XS	69 mm	55 mm
80-4212	XXS	59 mm	50 mm

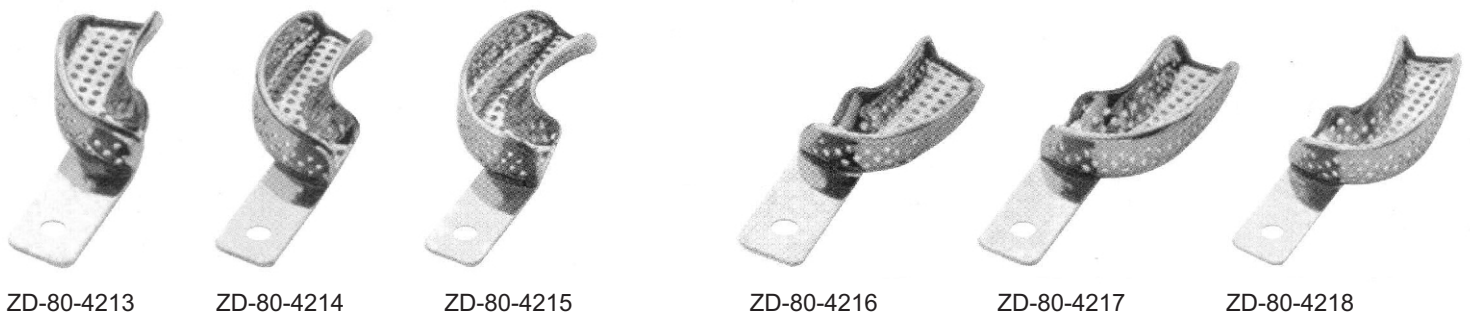
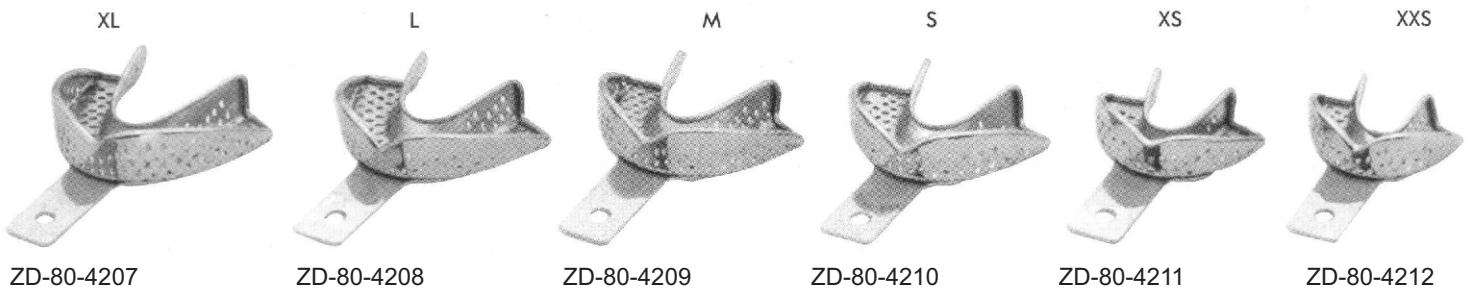

IMPRESSION TRAYS

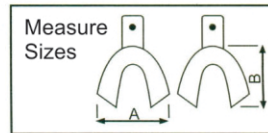
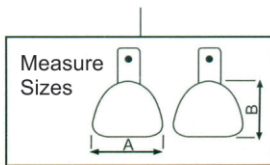
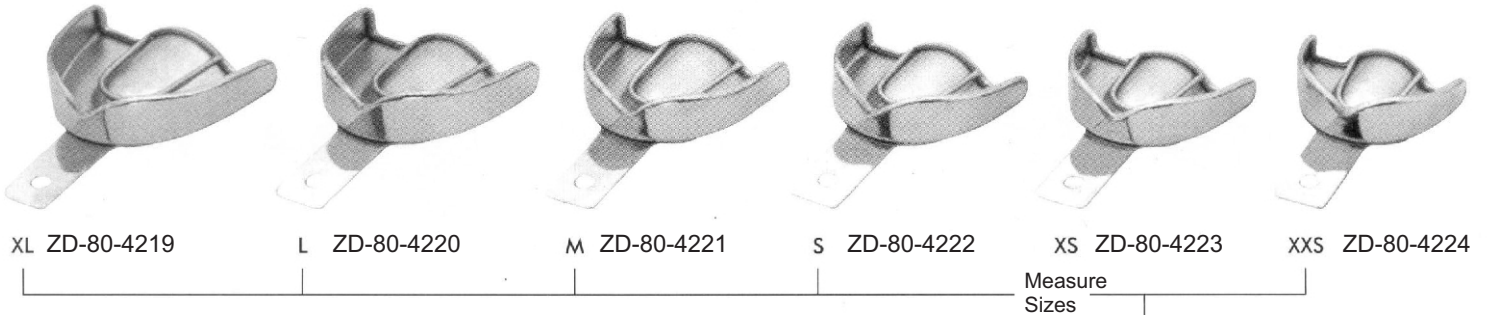

Upper		A (left-right)	B (top-bottom)
81-4219	XL	81 mm	63 mm
81-4220	L	73 mm	58 mm
81-4221	M	71 mm	52 mm
81-4222	S	67 mm	53 mm
81-4223	XS	65 mm	51 mm
81-4224	XXS	61 mm	50 mm

Lower		A (left-right)	B (top-bottom)
81-4225	XL	78 mm	63 mm
81-4226	L	74 mm	62 mm
81-4227	M	72 mm	59 mm
81-4228	S	70 mm	57 mm
81-4229	XS	69 mm	55 mm
81-4201	XXS	59 mm	50 mm

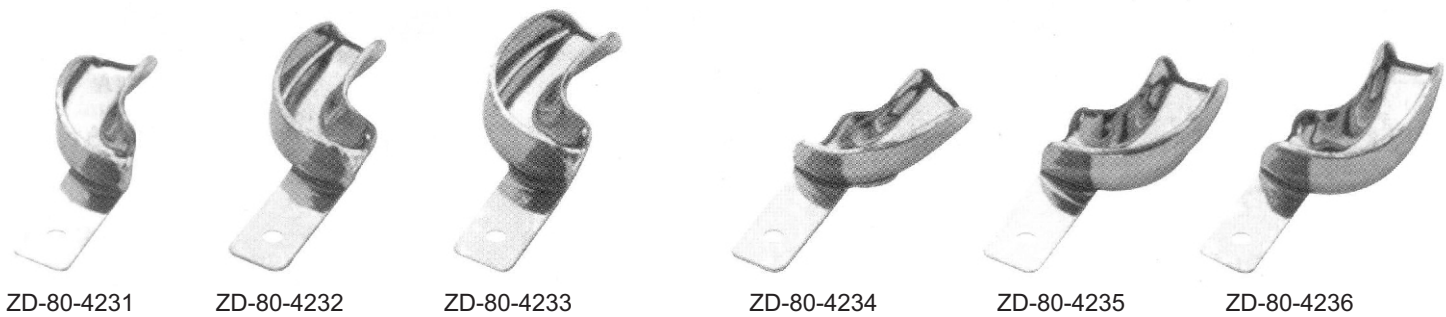
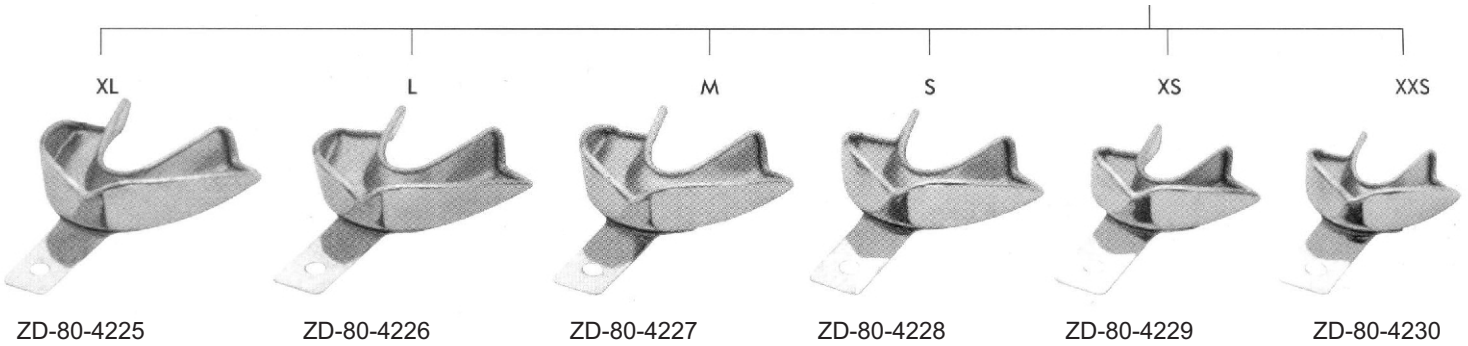

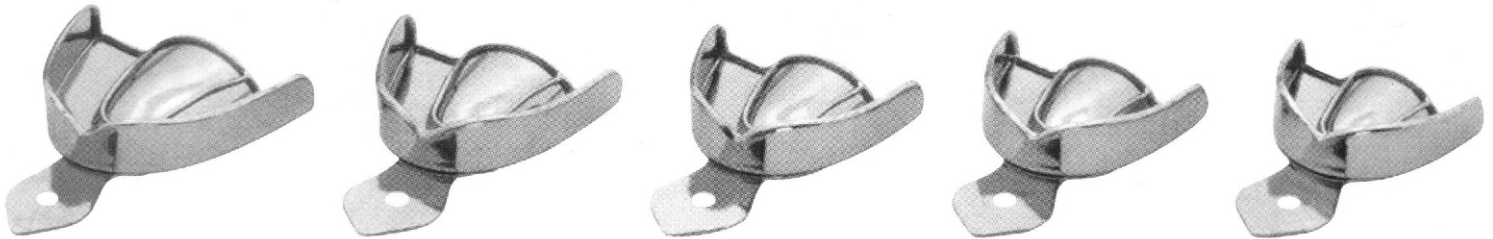

ZD-80-4237

ZD-80-4238

ZD-80-4239

ZD-80-4240

ZD-80-4241

XL

L

M

S

XS

Upper		A (left-right)	B (top-bottom)
ZD-80-4237	XL	81 mm	63 mm
ZD-80-4238	L	73 mm	58 mm
ZD-80-4239	M	71 mm	52 mm
ZD-80-4240	S	67 mm	53 mm
ZD-80-4241	XS	65 mm	51 mm

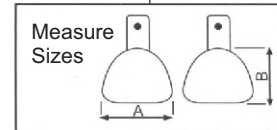

Lower		A (left-right)	B (top-bottom)
ZD-80-4242	XL	78 mm	63 mm
ZD-80-4243	L	74 mm	62 mm
ZD-80-4244	M	72 mm	59 mm
ZD-80-4245	S	70 mm	57 mm
ZD-80-4246	XS	69 mm	55 mm

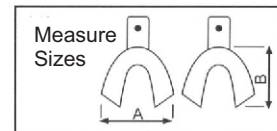

XL

L

M

S

XS



ZD-80-4242

ZD-80-4243

ZD-80-4244

ZD-80-4245

ZD-80-4246

IMPRESSION TRAYS

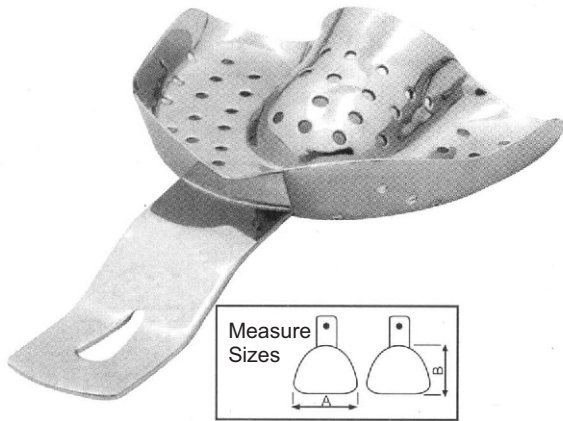

For Toothed Upper Jaws
 (Fig. 0 for children)

	A mm.	B mm.
ZD-80-4247 0	59	52
ZD-80-4248 1	66	52
ZD-80-4249 2	71	62
ZD-80-4250 3	71	64
ZD-80-4251 4	80	70

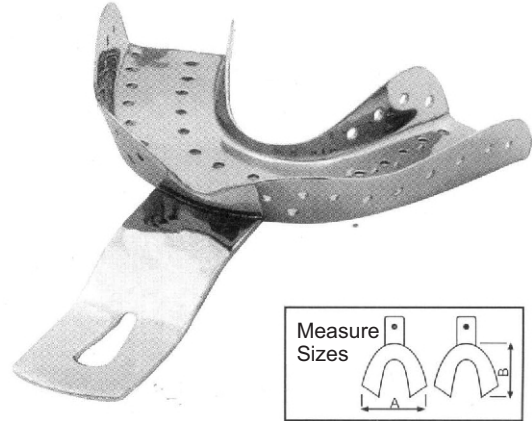

For Toothed Lower Jaws
 (Fig. 0 for children)

	A mm.	B mm.
ZD-80-4252 0	65	46
ZD-80-4253 1	67	50
ZD-80-4254 2	76	54
ZD-80-4255 3	79	56
ZD-80-4256 4	79	61

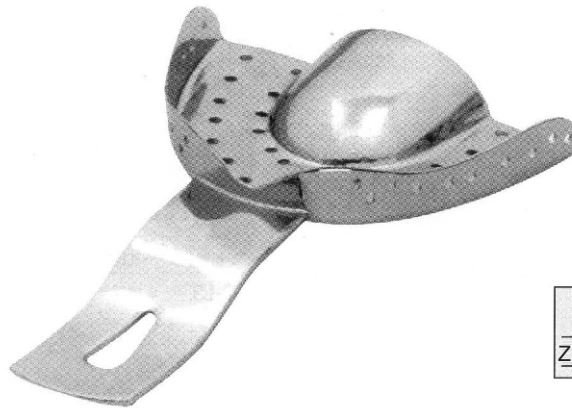

For Narrow Toothed Upper Jaws

	A mm.	B mm.
ZD-80-4257 2	70	54

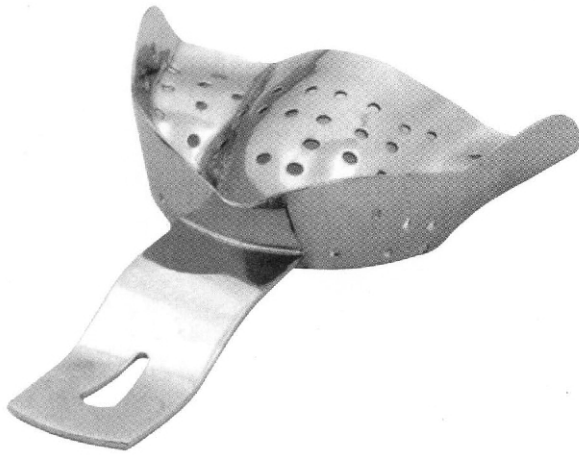

For partially toothed upper jaws

	A mm.	B mm.
ZD-80-4258 1	62	50
ZD-80-4259 2	70	56

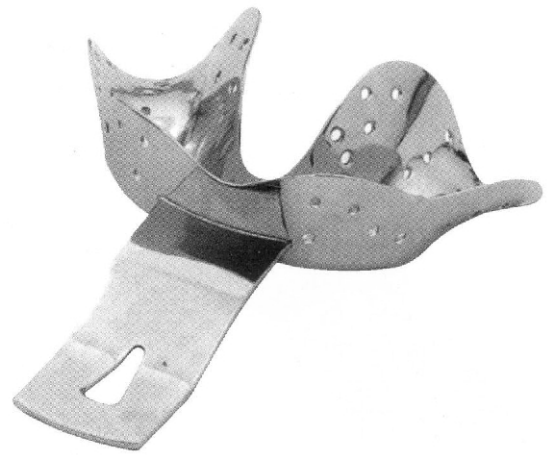
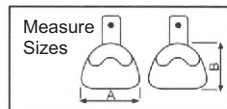

For partially toothed lower jaws

	A mm.	B mm.
ZD-80-4260 1	70	55
ZD-80-4261 2	78	59

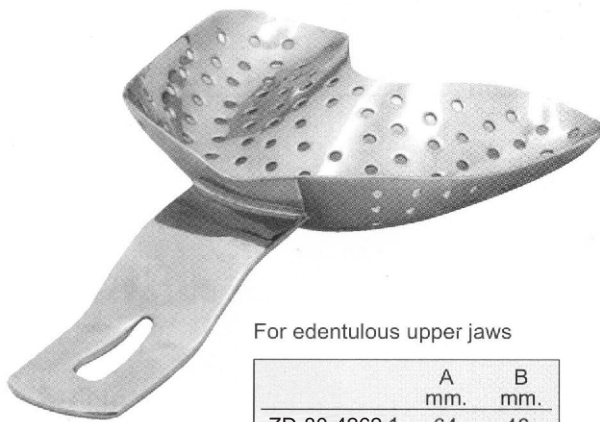
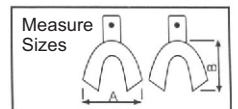

For edentulous upper jaws

	A mm.	B mm.
ZD-80-4262 1	64	46
ZD-80-4263 2	68	53
ZD-80-4264 3	79	61

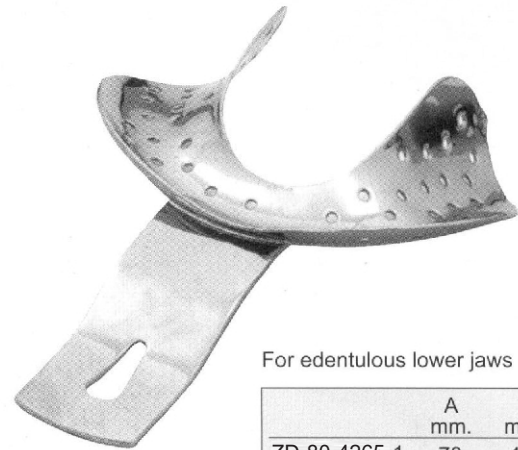

For edentulous lower jaws

	A mm.	B mm.
ZD-80-4265 1	70	48
ZD-80-4266 2	70	53
ZD-80-4267 3	72	57

IMPRESSION TRAYS



Solid stainless steel anterior depressed impression trays with retention rim.

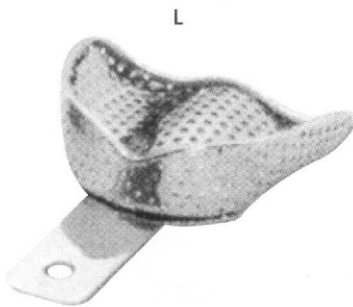
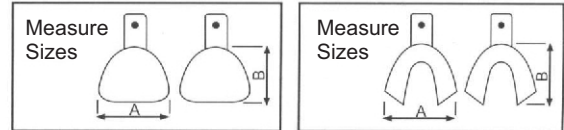

ZD-80-4268

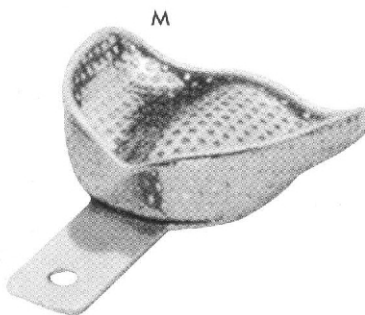

ZD-80-4269

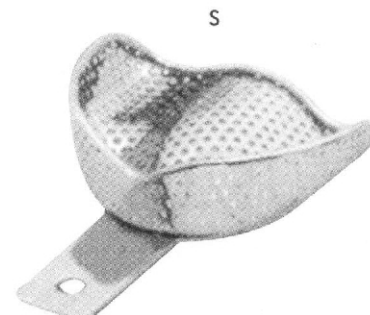

ZD-80-4270

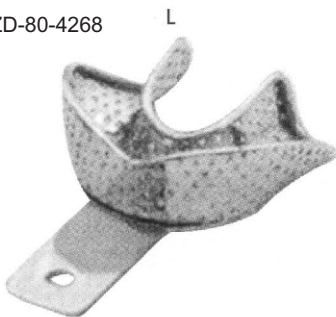

ZD-80-4271

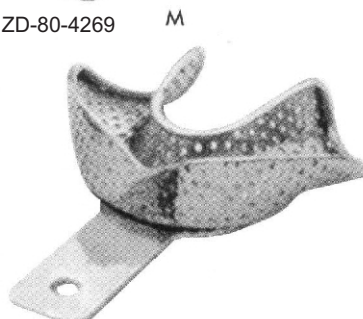

ZD-80-4272



ZD-80-4273

		A	B
		mm.	mm.
ZD-80-4268	L	81	67
ZD-80-4269	M	71	64
ZD-80-4270	S	70	57

		A	B
		mm.	mm.
ZD-80-4271	L	81	60
ZD-80-4272	M	79	57
ZD-80-4273	S	76	54



Solid total denture stainless steel impression trays with rim.

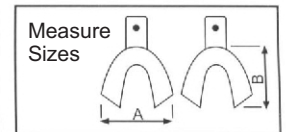
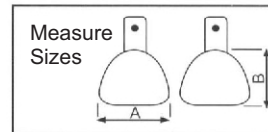

XL

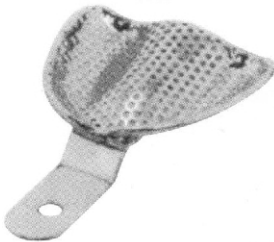

ZD-80-4274

L



ZD-80-4275

M

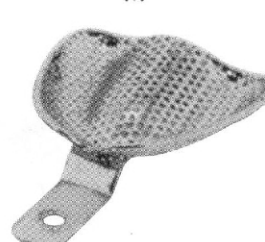

ZD-80-4276

S



ZD-80-4277

XL

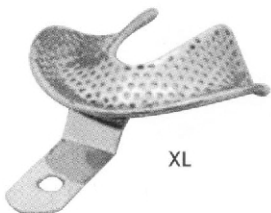

ZD-80-4278

L

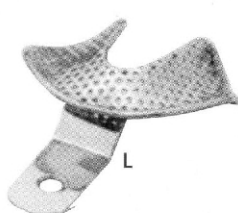

ZD-80-4279

M

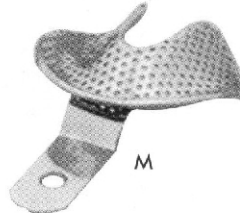

ZD-80-4280

S

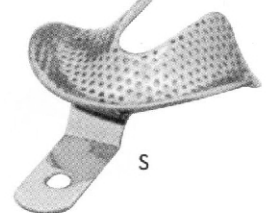

ZD-80-4281

	A mm.	B mm.
ZD-80-4274 XL	79	70
ZD-80-4275 L	76	67
ZD-80-4276 M	70	64
ZD-80-4277 S	73	60

	A mm.	B mm.
ZD-80-4278 XL	86	64
ZD-80-4279 L	70	64
ZD-80-4280 M	73	60
ZD-80-4281 S	70	57

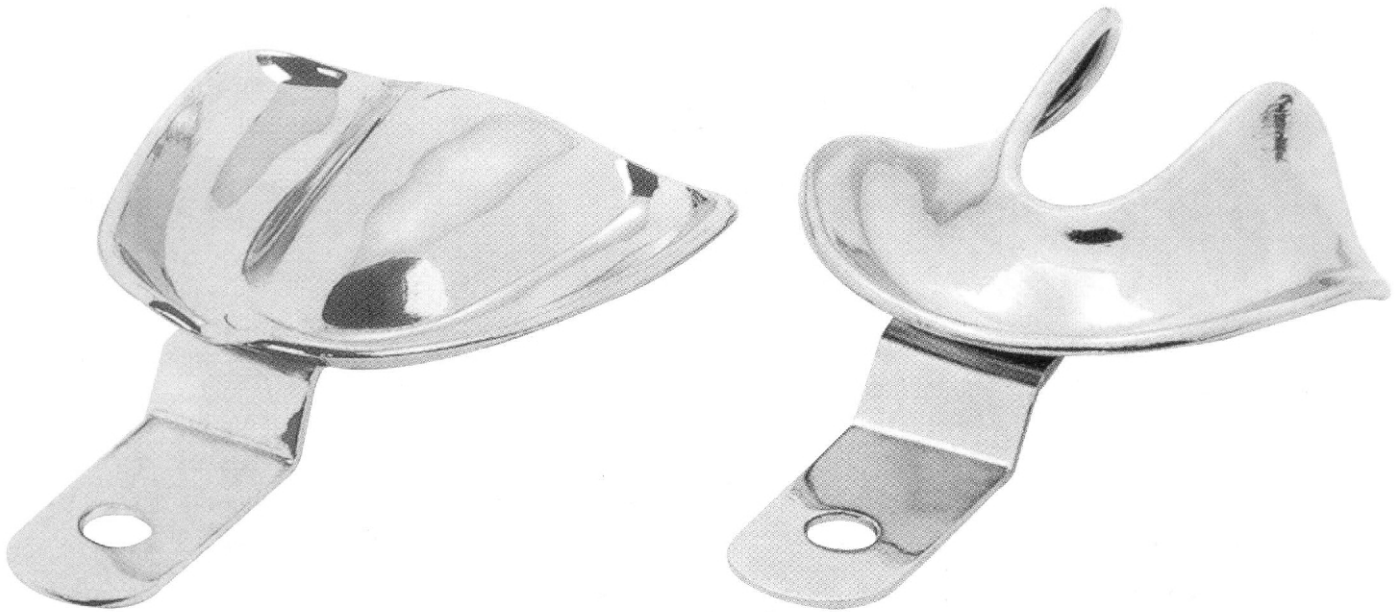

Solid total denture stainless steel impression trays with rim.

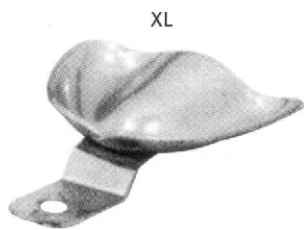
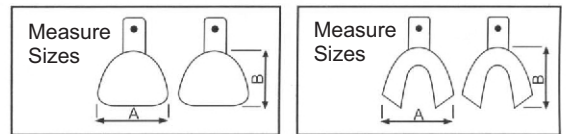

ZD-80-4288

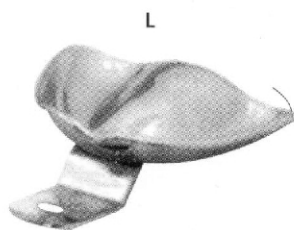

ZD-80-4289

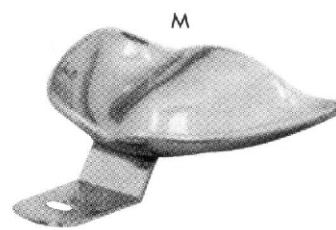

ZD-80-4290

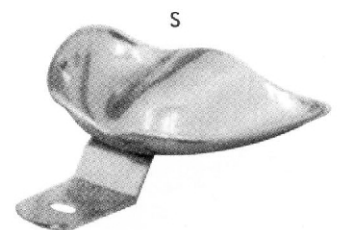

ZD-80-4291



ZD-80-4292



ZD-80-4293

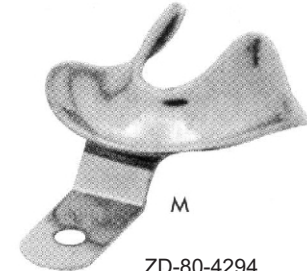

ZD-80-4294

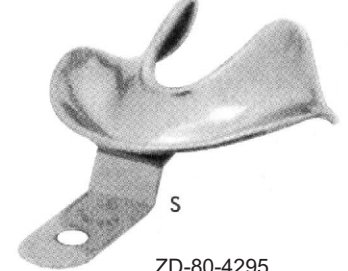

ZD-80-4295

	A mm.	B mm.
ZD-80-4288XL	79	70
ZD-80-4289 L	76	67
ZD-80-4290M	70	64
ZD-80-4291 S	73	60

	A mm.	B mm.
ZD-80-4292 XL	86	64
ZD-80-4293 L	70	64
ZD-80-4294 M	73	60
ZD-80-4295 S	70	57

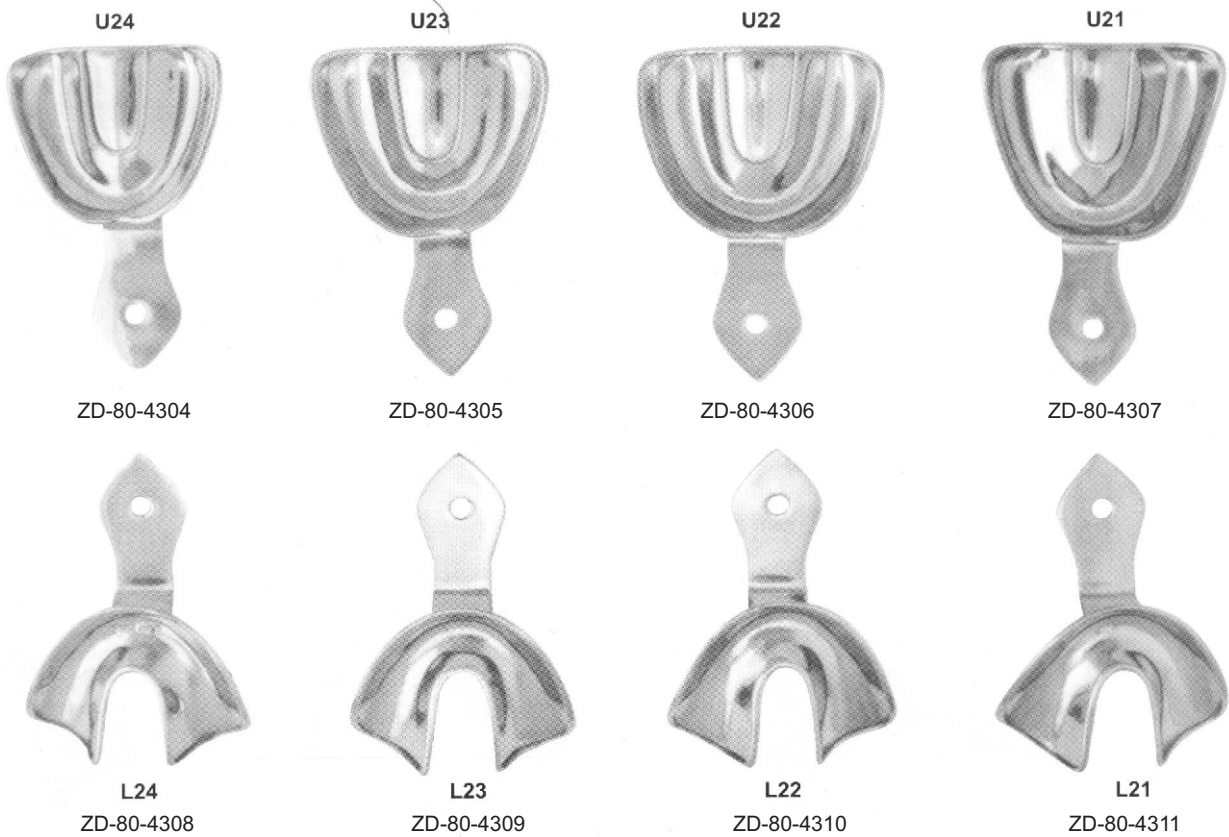
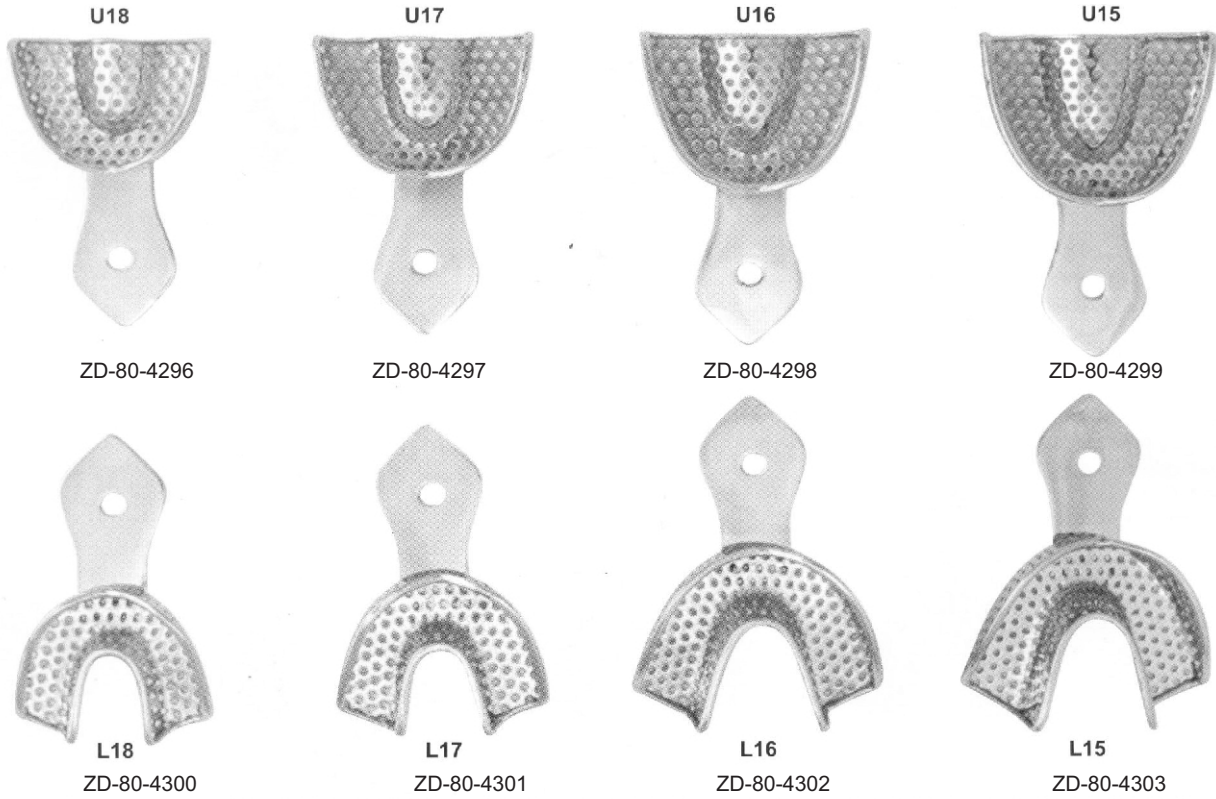

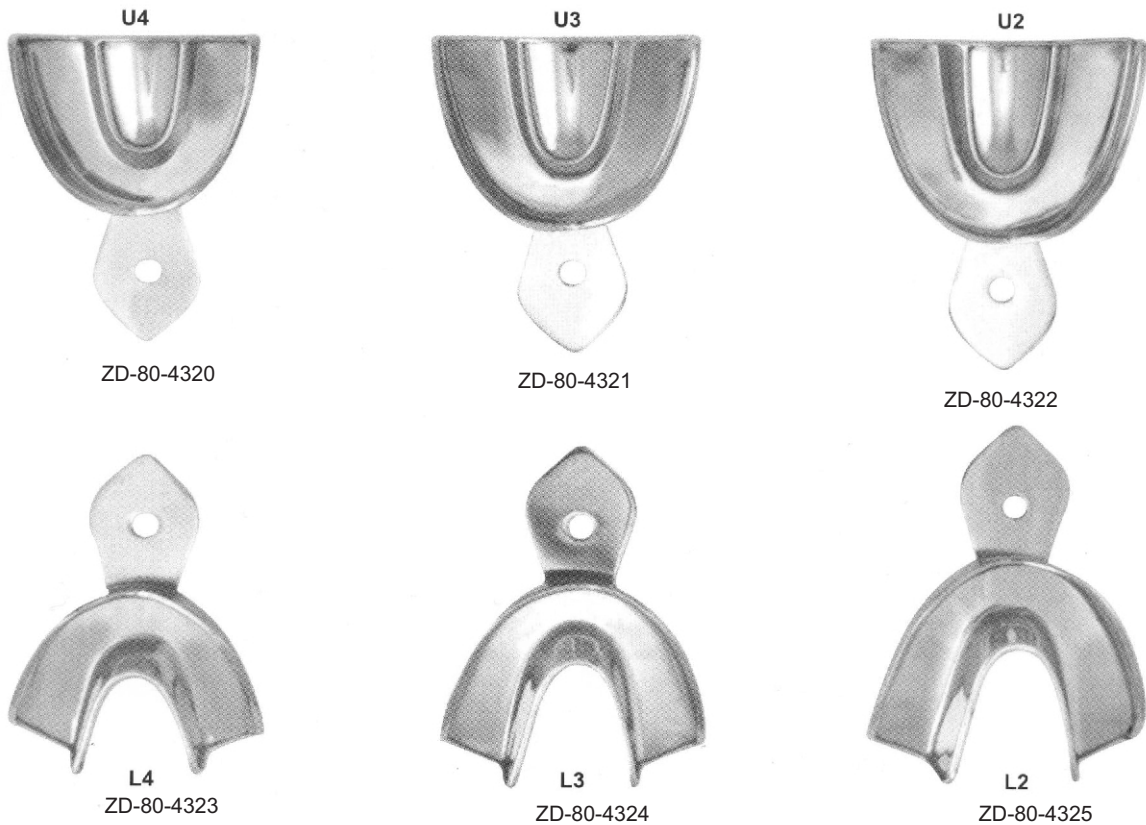
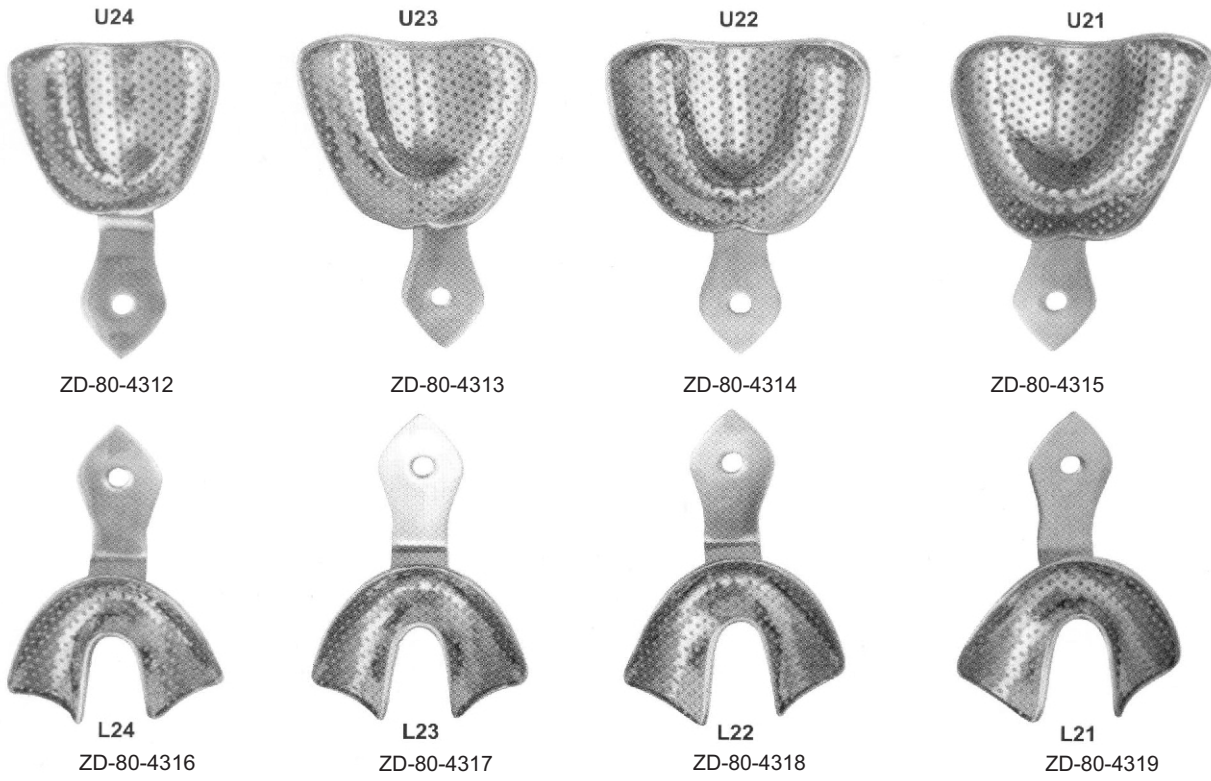

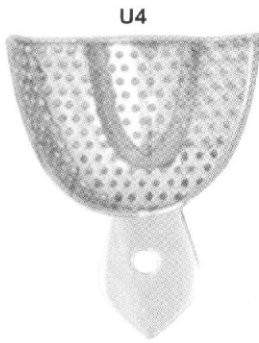

U4
ZD-80-4326

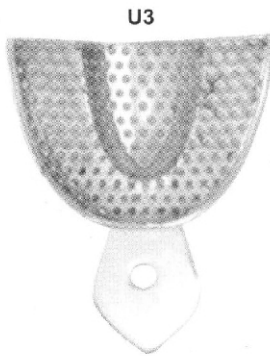

U3
ZD-80-4327

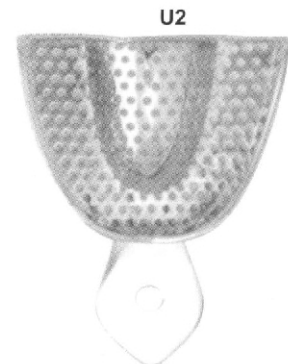

U2
ZD-80-4328

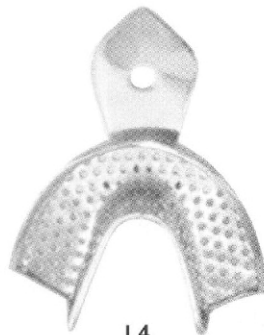

L4
ZD-80-4329

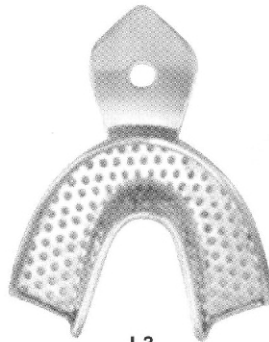

L3
ZD-80-4330

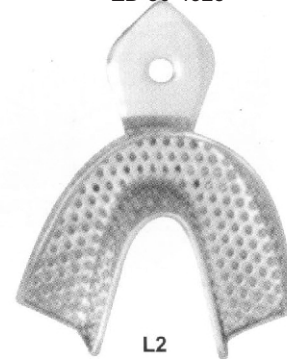

L2
ZD-80-4331



U15
ZD-80-4332



U16
ZD-80-4333



U17
ZD-80-4334



U18
ZD-80-4335



L15
ZD-80-4336



L16
ZD-80-4337

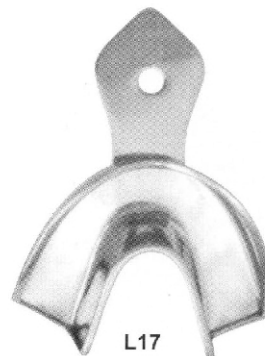

L17
ZD-80-4338

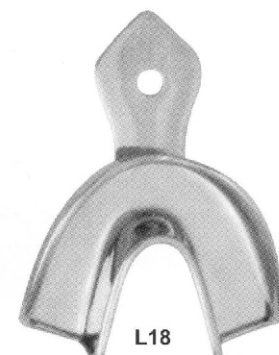

L18
ZD-80-4339

81

- EN** Articulators
- DE** Artikulatoren
- ES** Articuladores

Page 229 to 230



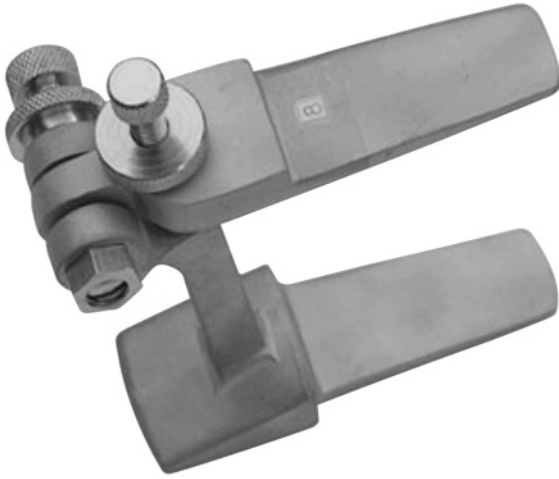

ZD-81-4301



ZD-81-4302



ZD-81-4303



ZD-81-4304



ZD-81-4306



ZD-81-4305

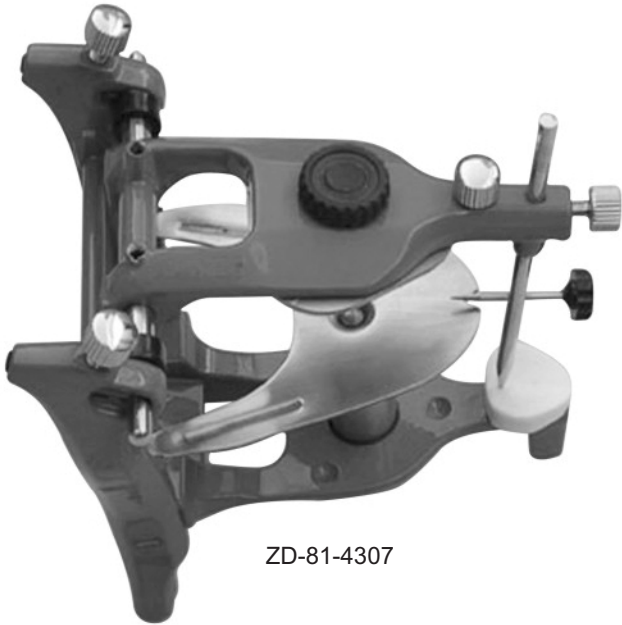

ZD-81-4307



ZD-81-4308



ZD-81-4309



ZD-81-4310



ZD-81-4312



ZD-81-4311

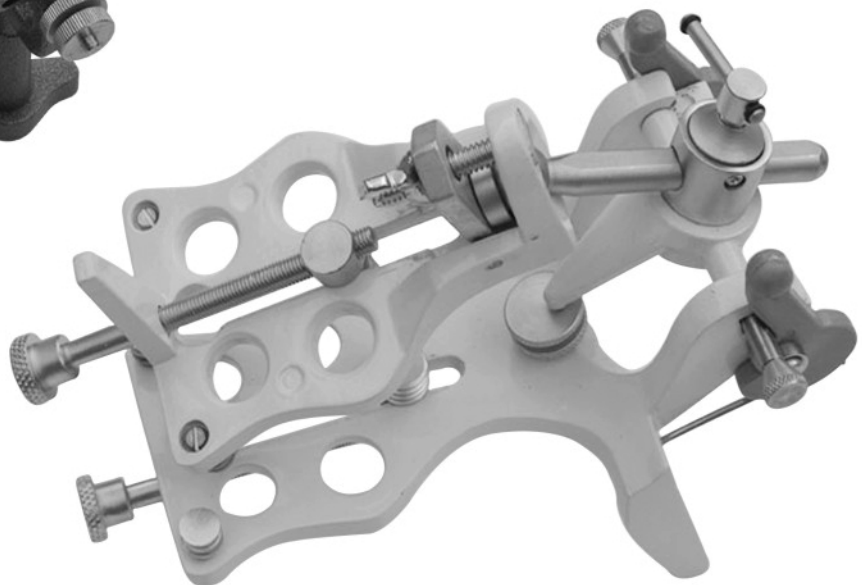

ZD-81-4313

82

EN	Holloware
DE	Holloware
ES	Holloware

Page 231 to 234





Needle Case Round with Cover
 ZD-82-4401 65x15mm



Needle Case Round
 ZD-82-4402 80x20mm



Needle Case Rectangle
 ZD-82-4403 70x70x10mm



Endodontic Box
 ZD-82-4404
 100x40x50mm

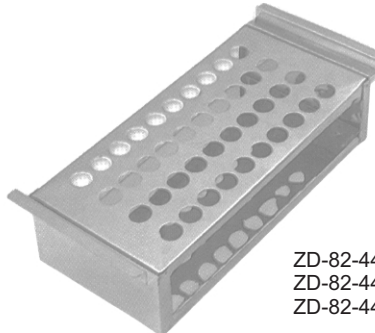

Tube Rack

ZD-82-4405 6.35x15.25x5cm for 12 tubes
 ZD-82-4406 6.35x17.75x7.5cm for 27 tubes
 ZD-82-4407 7.50x17.75x6.35cm for 36 tubes



Sprit Lamp
 ZD-82-4408
 Standard Size



Sprit Lamp
 ZD-82-4409
 Standard Size

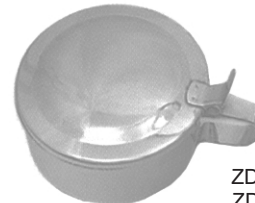

Sputum Cup
 ZD-82-4410 75x80mm
 ZD-82-4411 100x50mm
 ZD-82-4412 100x80mm



Dressing Jar

ZD-82-4413	80x60mm	ZD-82-4420
ZD-82-4414	80x80mm	ZD-82-4421
ZD-82-4415	100x100mm	ZD-82-4423
ZD-82-4416	120x120mm	ZD-82-4424
ZD-82-4417	150x150mm	ZD-82-4425
ZD-82-4418	180x180mm	ZD-82-4426
ZD-82-4419	200x200mm	ZD-82-4427



Dressing Jar



Fennle
 ZD-82-4428 100mm Ø
 ZD-82-4429 120mm Ø
 ZD-82-4430 150mm Ø
 ZD-82-4431 200mm Ø



Cotton Holder
 ZD-82-4432



Cotton Holder
 ZD-82-4433



Hollowware ● EN

Hohlkörper ● DE

Hollowware ● ES

**Forceps Jar**

SM-82-4434 30x90mm
 SM-82-4435 50x125mm
 SM-82-4436 50x170mm
 SM-82-4437 50x200mm
 SM-82-4438 40x230mm
 SM-82-4439 70x110mm
 SM-82-4440 80x150mm
 SM-82-4441 100x200mm
 SM-82-4442 150x30mm

**Medicine Cup**

SM-82-4461 50ml
 SM-82-4462 60ml
 SM-82-4463 70ml

**Kick Bucket with Trolley**

30-6819-01
 390x280x180mm

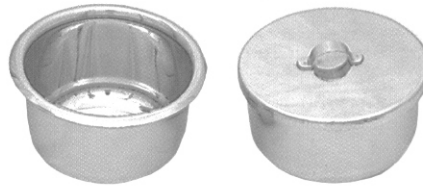
**Gallipot**

SM-82-4443 01 oz	SM-82-4450 09 oz
SM-82-4444 02 oz	SM-82-4451 10 oz
SM-82-4445 03 oz	SM-82-4452 11 oz
SM-82-4446 04 oz	SM-82-4453 12 oz
SM-82-4447 05 oz	SM-82-4454 13 oz
SM-82-4448 06 oz	SM-82-4455 14 oz
SM-82-4448A 07 oz	SM-82-4456 15 oz
SM-82-4449 08 oz	SM-82-4457 16 oz

**Sponge Bowl**

SM-82-4458 12 cm
 SM-82-4459 15 cm
 SM-82-4460 20 cm

**Lotion Bowl without spout**

SM-82-4464 40x19mm	SM-82-4471 150x65mm
SM-82-4465 50x25mm	SM-82-4472 180x85mm
SM-82-4466 60x30mm	SM-82-4473 200x100mm
SM-82-4467 80x40mm	SM-82-4474 250x120mm
SM-82-4468 100x50mm	SM-82-4475-12 300mm
SM-82-4469 120x60mm	SM-82-4476-13 350mm
SM-82-4470 140x60mm	SM-82-4477-14 400mm

**Wash Basin**

SM-82-4478 300x80mm
 SM-82-4479 320x85mm
 SM-82-4480 330x90mm
 SM-82-4481 350x110mm
 SM-82-4482 400x115mm

**Kidney Tray**

SM-82-4486 12cm
 SM-82-4487 15cm
 SM-82-4488 18cm
 SM-82-4489 20cm
 SM-82-4490 25cm
 SM-82-4491 28cm
 SM-82-4492 30cm

**Kidney Tray Shallow**

SM-82-4483 17cm
 SM-82-4484 22cm
 SM-82-4485 24cm

**Kidney Tray (with cover)**

SM-82-4493 15cm
 SM-82-4494 20cm
 SM-82-4495 25cm
 SM-82-4496 30cm

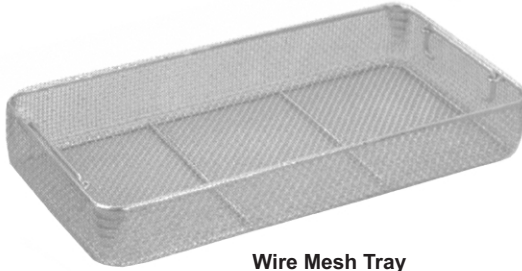

Wire Mesh Tray

- ZD-82-4497 240x250x5mm
- ZD-82-4498 480x250x5mm
- ZD-82-4499 550x250x5mm
- ZD-82-4500 240x250x7mm
- ZD-82-4501 480x250x7mm
- ZD-82-4502 240x250x10mm
- ZD-82-4503 480x250x10mm

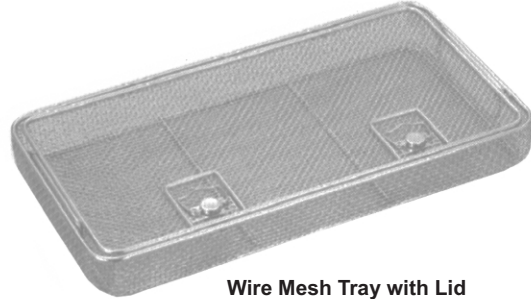

Wire Mesh Tray with Lid

- ZD-82-4504 240x250x5mm
- ZD-82-4505 480x250x5mm
- ZD-82-4506 550x250x5mm
- ZD-82-4507 240x250x7mm
- ZD-82-4508 480x250x7mm
- ZD-82-4509 240x250x10mm
- ZD-82-4510 480x250x10mm



Perforated Tray

- ZD-82-4511 200x100x40mm
- ZD-82-4512 250x120x50mm
- ZD-82-4513 300x150x50mm
- ZD-82-4514 350x170x50mm
- ZD-82-4515 400x200x50mm



Instruments Tray without Lid

- ZD-82-4516 100x150x25mm
- ZD-82-4517 150x200x40mm
- ZD-82-4518 200x250x45mm
- ZD-82-4519 250x300x50mm
- ZD-82-4520 300x350x50mm
- ZD-82-4521 150x300x50mm
- ZD-82-4522 200x300x50mm
- ZD-82-4523 230x150x50mm



Instruments Tray with Lid

- ZD-82-4524 100x150x25mm
- ZD-82-4525 150x200x40mm
- ZD-82-4526 200x250x45mm
- ZD-82-4527 250x300x50mm
- ZD-82-4528 300x350x50mm
- ZD-82-4529 150x300x50mm
- ZD-82-4530 200x300x50mm
- ZD-82-4531 230x150x50mm



Burr Tray

- ZD-82-4532
- 190x100x20mm

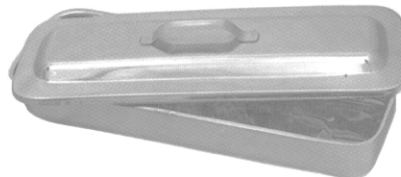

Cathetes Tray with Lid

- ZD-82-4533 300x80x40mm
- ZD-82-4534 350x90x45mm
- ZD-82-4535 400x100x50mm

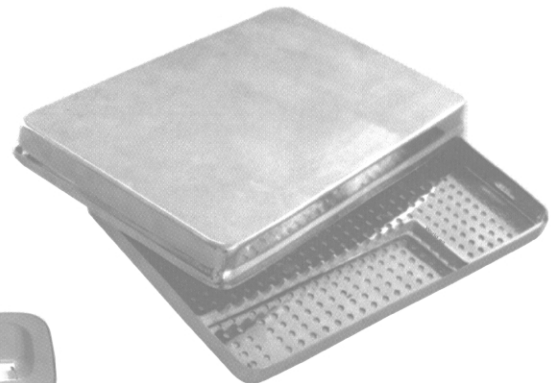

Scaler Tray with cover

- ZD-82-4536
- 200x100x16mm

Hollowware ● EN
 Hohlkörper ● DE
 Hollowware ● ES



**Instruments Box
with Hooks**

ZD-82-4537 170x70x30mm
 ZD-82-4538 180x80x40mm
 ZD-82-4539 200x100x40mm
 ZD-82-4540 230x120x50mm
 ZD-82-4541 250x125x50mm
 ZD-82-4542 300x150x50mm
 ZD-82-4543 350x170x50mm
 ZD-82-4544 400x200x90mm
 ZD-82-4545 500x200x120mm



Instruments Box

ZD-82-4546 170x70x30mm
 ZD-82-4547 180x80x40mm
 ZD-82-4548 200x100x40mm
 ZD-82-4549 230x120x50mm
 ZD-82-4550 250x125x50mm
 ZD-82-4551 300x150x50mm
 ZD-82-4552 350x170x50mm
 ZD-82-4553 400x200x90mm
 ZD-82-4554 500x200x120mm



**Instruments Box
Perforated**

ZD-82-4555 200x100x40mm
 ZD-82-4556 250x150x40mm
 ZD-82-4557 300x150x40mm



Electric Sterilizer

ZD-82-4558 200x100x120mm
 ZD-82-4559 250x120x140mm
 ZD-82-4560 300x150x150mm
 ZD-82-4561 350x170x170mm
 ZD-82-4562 400x200x180mm
 ZD-82-4563 450x230x190mm

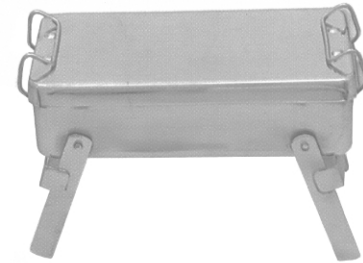

Non Electric Sterilizer

ZD-82-4564 200x100x65mm
 ZD-82-4565 250x125x65mm
 ZD-82-4566 300x150x100mm
 ZD-82-4567 350x170x65mm
 ZD-82-4568 400x200x100mm



Electric Sterilizer
 ZD-82-4569
 280x125x65mm

ZD-82-4570 125x80mm
 ZD-82-4571 125x120mm
 ZD-82-4572 150x100mm
 ZD-82-4573 150x150mm
 ZD-82-4574 180x180mm
 ZD-82-4575 190x140mm
 ZD-82-4576 190x190mm
 ZD-82-4577 200x200mm
 ZD-82-4578 240x120mm
 ZD-82-4579 240x240mm
 ZD-82-4580 290x140mm
 ZD-82-4581 290x240mm
 ZD-82-4582 290x290mm
 ZD-82-4583 340x160mm
 ZD-82-4584 340x340mm
 ZD-82-4585 390x150mm
 ZD-82-4586 390x200mm
 ZD-82-4587 390x290mm



Sterilizer Drum



ZONA INDUSTRIES
Pul Aik, Aminabad Road
Sialkot-51310, Pakistan
Tel: +92 52 3522403
Whatsapp CEO: 0092 300 8616124
Email: zona@zona.com.pk
Web: www.zona.com.pk
Web: www.zonadental.com

